



**Description**

IP66, Class III. IK07. Marine-grade, die-cast aluminium alloy. 5CE superior corrosion protection including PCS hardware. Silicone CCG® Controlled Compression Gasket. Safety glass lens. Electronic control gear in separate gear box (constant current), prewired. Gearbox to be ordered separately. One factory installed flange plug M8 x 1.5. Cable length 3.0 m. CAD-optimised optics for superior illumination and glare control. Factory-installed LED circuit board.

Maximum one internal optical accessory possible. To be specified at time of ordering.

Specifications**Material description**

Body	Marine-grade, die-cast aluminium alloy
Lens	Safety glass lens
Colours	 RAL9004 Signal black  RAL9006 White aluminium  RAL9007 Grey aluminium  RAL7016 Anthracite grey  RAL9016 Traffic white
Gasket	Silicone CCG® Controlled Compression Gasket
Fasteners	PCS Polymer Coated Stainless Steel Hardware
Ingress protection	IP66
Impact resistance	IK07
Corrosion resistance	5CE
Windage	0.006 m ²

Electrical description

Power supply	220-240V / 50-60 Hz
Driver / Ballast	Standard, DALI on request
Power factor	> 0.9

Additional information

Lifetime	Ta=25° L90B10 > 90000h
Energy efficiency class	D-E (Light source)

Options

Light distribution

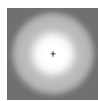

symmetric, wide beam [B]



symmetric, medium beam [M]



symmetric, narrow beam [E]



symmetric, very narrow beam [EE]



symmetric, very narrow beam, sharp cut-off [EES]

Colour temperature



2700 K



3000 K





4000 K

Nominal Watt

0 W

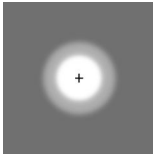
Configurations

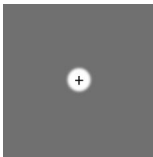
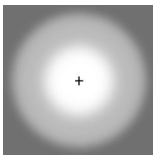
Light distribution	Part ID	Light source	Rated lumens	Rated input power	CRI	Weight (kg)
symmetric, medium beam [M] 	139-2438	LED-1/6W / 500 mA - 2700 K	544.8	7.5 W	80	0.50
	139-2439	LED-1/6W / 500 mA - 3000 K	544.8	7.5 W	80	0.50
	139-2440	LED-1/6W / 500 mA - 4000 K	585.5	7.5 W	80	0.50
symmetric, narrow beam [E] 	139-2441	LED-1/6W / 500 mA - 2700 K	567.7	7.5 W	80	0.50
	139-2442	LED-1/6W / 500 mA - 3000 K	567.7	7.5 W	80	0.50
	139-2443	LED-1/6W / 500 mA - 4000 K	610.1	7.5 W	80	0.50
symmetric, very narrow beam [EE] 	139-2444	LED-1/6W / 500 mA - 2700 K	568.2	7.5 W	80	0.50
	139-2445	LED-1/6W / 500 mA - 3000 K	568.2	7.5 W	80	0.50
	139-2446	LED-1/6W / 500 mA - 4000 K	610.6	7.5 W	80	0.50
symmetric, very narrow beam, sharp cut-off [EES] 	139-2447	LED-1/6W / 500 mA - 2700 K	516.6	7.5 W	80	0.50
	139-2448	LED-1/6W / 500 mA - 3000 K	516.6	7.5 W	80	0.50
	139-2449	LED-1/6W / 500 mA - 4000 K	558.6	7.5 W	80	0.50
symmetric, wide beam [B] 	139-2435	LED-1/6W / 500 mA - 2700 K	518.4	7.5 W	80	0.50
	139-2436	LED-1/6W / 500 mA - 3000 K	518.4	7.5 W	80	0.50
	139-2437	LED-1/6W / 500 mA - 4000 K	557.1	7.5 W	80	0.50

Optical Accessories

Linear spread lens

Description	Part ID	C1
IO-180-FLC201-LED	139-2453	41.8



Honeycomb louvre

Description	Part ID	C1
IW-FLC201-LED - [EE][EES]	139-2454	48

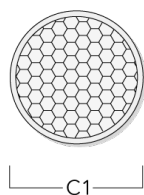

Glare shield

Fagerhult Lighting Ltd

33-34 Dolben Street, SE1 0UQ London, United Kingdom

<https://we-ef.com/uk>

Subject to technical changes and errors. - Generated on 23/10/2024

Projectors

Description	Part ID	A	C1
ES-FLC201-LED	139-2455	59.5	75

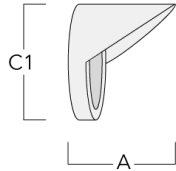

Snoot

Description	Part ID	A	C1
ET-FLC201-LED	139-2456	60	75

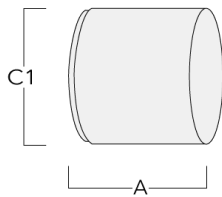

Electrical Accessories

Gear box

Description	Part ID	A	B	C1	C2	Weight (kg)
GB200 R130x80 gear box (small) DALI	139-2555	50	80	159	130	0.30

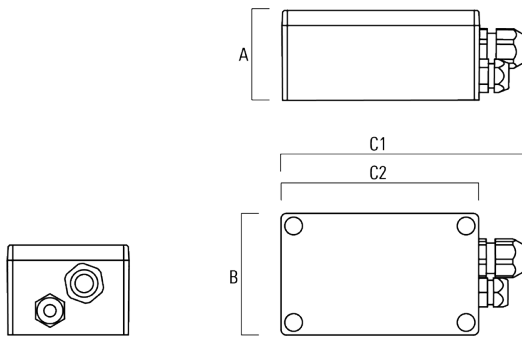

GB200 R200x120 gear box (medium) DALI	139-2622	75	120	229	200	
--	----------	----	-----	-----	-----	--

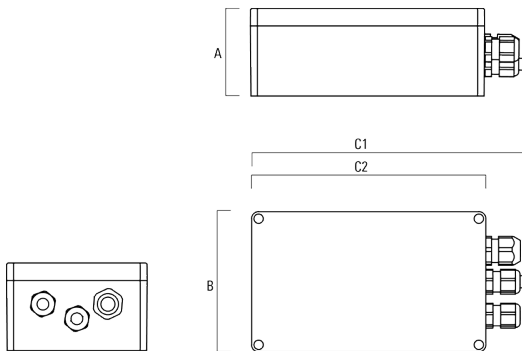

Description	Part ID	A	B	C1	C2	Weight (kg)
GB200 R230x140 gear box (large) SP10 DALI	139-2621	95	140	259	230	

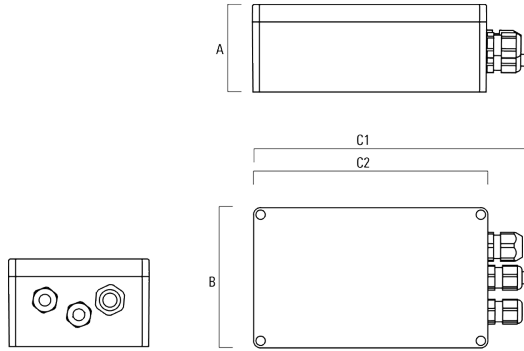

Mounting Accessories

Junction box

Description	Part ID	A	B	C1	C2
JB200 R82 Junction box	139-2590	55	82	140	80

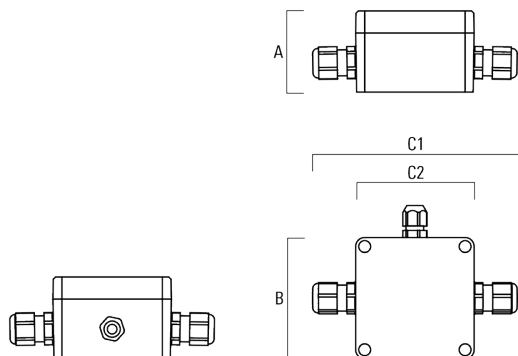

Pole clamp PC

Description	Part ID	D1	Weight (kg)
PC2 114-133/60 Pole clamp, double (Ø 114-133)	139-2709	114-133	1.40

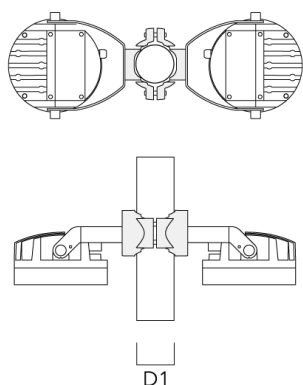

FLC201 LED

Projectors

Fagerhult Lighting Ltd

33-34 Dolben Street, SE1 0UQ London, United Kingdom

<https://we-ef.com/uk>

Subject to technical changes and errors.
Generated on 23/10/2024