



**Beschreibung**

IP66, SKIII. IK07. Korrosionsbeständiger Aluminiumguss. PCS beschichtete Edelstahlschrauben. 5CE Korrosionsschutz. CCG® Silikondichtung. Sicherheitsglas. Elektronisches Betriebsgerät in externer vorverdrahteter Gerätebox (Konstantstrom). Gerätebox separat zu bestellen. Ein eingebauter Flanschstecker M8 x 1,5. Anschlussleitung 3 m. CAD-optimierte Technik zur Lichtlenkung und Entblendung. Eingebaute LED Platine.

Maximal ein internes Zubehörteil möglich, bei Bestellung bitte angeben.

**Spezifikationen****Materialbeschreibung**

---

Gehäuse	Korrosionsbeständiger Aluminiumguss
Abdeckung	Sicherheitsglas
Farben	 RAL9004 Signalschwarz  RAL9007 Graualuminium  RAL7016 Anthrazitgrau  RAL9016 Verkehrsweiß
Dichtung	CCG® Silikondichtung
Schrauben	PCS beschichtete Edelstahlschrauben
Schutzart	IP66
Schlagfestigkeit	IK07
Korrosionsbeständigkeit	5CE
Windangriffsfläche	0.065 ft <sup>2</sup>

---

**Elektrische Beschreibung**

---

Netzgerät / Vorschaltgerät	Standard, DALI auf Anfrage
Leistungsfaktor	> 0.9

---

**Weitere Informationen**

---

Lifetime	Ta=25° L90B10 > 90000h
Energieeffizienzklasse	D-E (Lichtquelle)

---

# FLC201 LED

## Scheinwerfer symmetrisch

**we-ef**

### Auswahl

#### Lichtverteilung



symmetrisch breitstrahlend [B]



symmetrisch mediumstrahlend [M]



symmetric, narrow beam [E]



symmetrisch extrem engstrahlend [EE]



symmetrisch extrem engstrahlend, 'sharp cut-off' [EES]

#### Farbtemperaturen



2700 K



3000 K



4000 K

#### Nominal Watt

0 W



#### WE-EF Switzerland AG

Himmelrichstrasse 6, 6003 Luzern - Tel: +41 41 210 49 95

info.switzerland@we-ef.com - [https://we-ef.com/ch\\_de](https://we-ef.com/ch_de)

Technische Änderungen und Irrtümer vorbehalten. - Erstellt am 23.11.2024

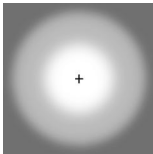
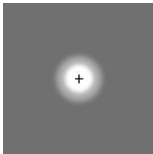
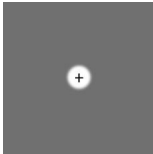
### Konfigurationen

Lichtverteilung	Artikelnummer	Lichtquelle	Bemes- sungslicht- strom	Bemes- sungsleis- tung	CRI	Gewicht (kg)
symmetric, narrow beam [E] 	139-2441	LED-1/6W / 500 mA - 2700 K	567.7	7.5 W	80	0.50
	139-2442	LED-1/6W / 500 mA - 3000 K	567.7	7.5 W	80	0.50
	139-2443	LED-1/6W / 500 mA - 4000 K	610.1	7.5 W	80	0.50
symmetrisch breitstrahlend [B] 	139-2435	LED-1/6W / 500 mA - 2700 K	518.4	7.5 W	80	0.50
	139-2436	LED-1/6W / 500 mA - 3000 K	518.4	7.5 W	80	0.50
	139-2437	LED-1/6W / 500 mA - 4000 K	557.1	7.5 W	80	0.50
symmetrisch extrem engstrahlend [EE] 	139-2444	LED-1/6W / 500 mA - 2700 K	568.2	7.5 W	80	0.50
	139-2445	LED-1/6W / 500 mA - 3000 K	568.2	7.5 W	80	0.50
	139-2446	LED-1/6W / 500 mA - 4000 K	610.6	7.5 W	80	0.50
symmetrisch extrem engstrahlend, 'sharp cut-off' [EES] 	139-2447	LED-1/6W / 500 mA - 2700 K	516.6	7.5 W	80	0.50
	139-2448	LED-1/6W / 500 mA - 3000 K	516.6	7.5 W	80	0.50
	139-2449	LED-1/6W / 500 mA - 4000 K	558.6	7.5 W	80	0.50
symmetrisch mediumstrahlend [M] 	139-2438	LED-1/6W / 500 mA - 2700 K	544.8	7.5 W	80	0.50
	139-2439	LED-1/6W / 500 mA - 3000 K	544.8	7.5 W	80	0.50
	139-2440	LED-1/6W / 500 mA - 4000 K	585.5	7.5 W	80	0.50

# FLC201 LED

Scheinwerfer symmetrisch

**we-ef**

## Optisches Zubehör

### Streulinse bandförmig

Beschreibung	Artikelnummer	C1
IO-180-FLC201-LED	139-2453	41.8



### Wabenblende

Beschreibung	Artikelnummer	C1
IW-FLC201-LED - [EE][EES]	139-2454	48

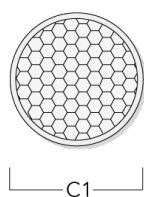

#### WE-EF Switzerland AG

Himmelrichstrasse 6, 6003 Luzern - Tel: +41 41 210 49 95

info.switzerland@we-ef.com - [https://we-ef.com/ch\\_de](https://we-ef.com/ch_de)

Technische Änderungen und Irrtümer vorbehalten. - Erstellt am 23.11.2024

**Scheinwerfer symmetrisch****Seitenblende**

---

Beschreibung	Artikelnummer	A	C1
ES-FLC201-LED	139-2455	59.5	75

---

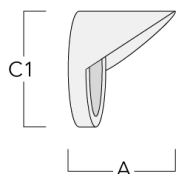

---

**Abblendtubus**

---

Beschreibung	Artikelnummer	A	C1
ET-FLC201-LED	139-2456	60	75

---

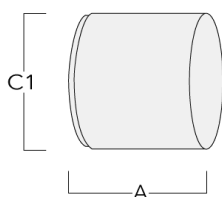

### Elektrisches Zubehör

#### Gerätebox

Beschreibung	Artikelnummer	A	B	C1	C2	Gewicht (kg)
GB200 R130x80 Gerätebox (klein) DALI	139-2555	50	80	159	130	0.30

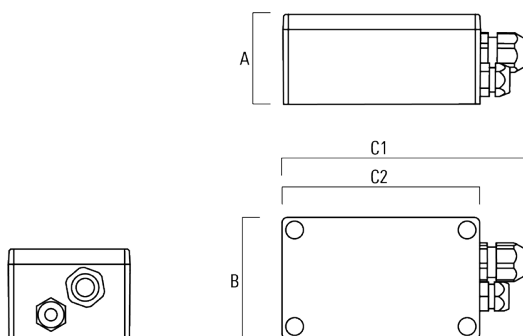

GB200 R200x120 Gerätebox (mittel) DALI	139-2622	75	120	229	200	
---	----------	----	-----	-----	-----	--

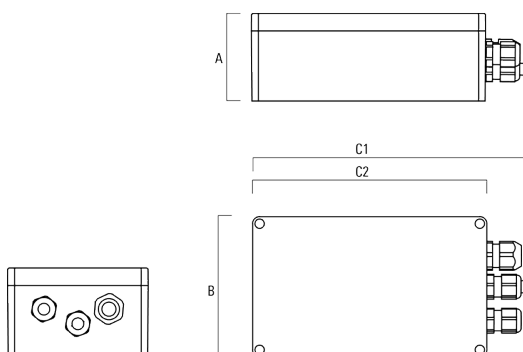

## Scheinwerfer symmetrisch

Beschreibung	Artikelnummer	A	B	C1	C2	Gewicht (kg)
GB200 R230x140 Gerätebox (groß) SP10 DALI	139-2621	95	140	259	230	

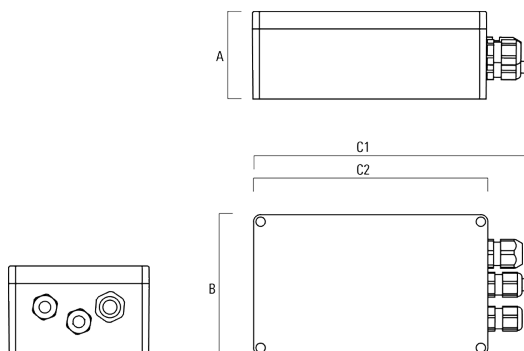



### Montagezubehör

#### Verteilerbox

Beschreibung	Artikelnummer	A	B	C1	C2
JB200 R82 Verteilerbox	139-2590	55	82	140	80

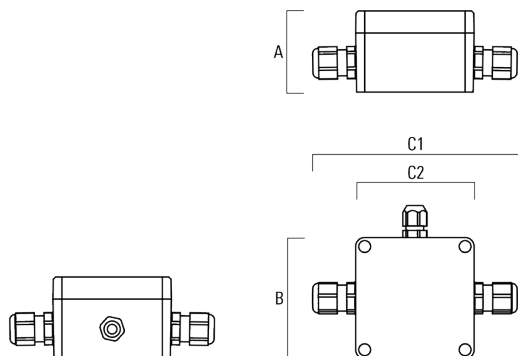

#### Mastschelle PC

Beschreibung	Artikelnummer	D1	Gewicht (kg)
PC2 114-133/60 Mastschelle, zweifach (Ø 114-133)	139-2709	114-133	1.40

