

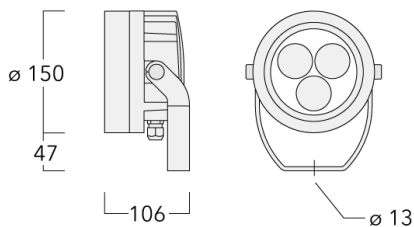







Description

Tunable White. IP66, Class I. Class II on request. IK07. Marine-grade, die-cast aluminium alloy. 5CE superior corrosion protection including PCS hardware. Silicone CCG® Controlled Compression Gasket. Safety glass lens. One cable gland. Second gland for through-wiring on request. Integral EC electronic converter in thermally-separated compartment. CAD-optimised optics for superior illumination and glare control. OLC® One LED Concept. Factory-installed LED circuit board, Tunable White Technology. DALI interface.



Projectors**Specifications****Material description**

Body	Marine-grade, die-cast aluminium alloy
Lens	Safety glass lens
Colours	 RAL9004 Signal black  RAL9006 White aluminium  RAL9007 Grey aluminium  RAL7016 Anthracite grey  RAL9016 Traffic white
Gasket	Silicone CCG® Controlled Compression Gasket
Fasteners	PCS Polymer Coated Stainless Steel Hardware
Ingress protection	IP66
Impact resistance	IK07
Corrosion resistance	5CE
Windage	0.018 m ²

Electrical description

Power supply	220-240V / 50-60 Hz
Driver / Ballast	DALI
Power factor	> 0.9
Surge protection	6/6 kV (optional SP10)

Additional information

Lifetime	Ta=25° L90B10 > 90000h
Energy efficiency class	E (Light source)

FLC210-TW LED

Projectors

Options

Light distribution



symmetric, wide beam [B]



symmetric, medium beam [M]



symmetric, narrow beam [E]



Colour temperature

2200-6000K

Nominal Watt

0 W

Configurations

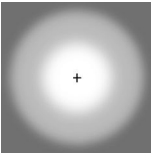
Light distribution	Part ID	Light source	Rated lumens	Rated input power	CRI	Weight (kg)
symmetric, medium beam [M] 	139-2418	LED-3/11W - 2200-6000 K	963.4	13 W	80	4.00
symmetric, narrow beam [E] 	139-2419	LED-3/11W - 2200-6000 K	980.7	13 W	80	4.00
symmetric, wide beam [B] 	139-2417	LED-3/11W - 2200-6000 K	953.5	13 W	80	4.00

Projectors

Optical Accessories

Glare shield

Description	Part ID	A	C1
ES-FLC210-LED	139-2406	86	149

Snoot

Description	Part ID	A	C1
ET-FLC210-LED	139-2407	86	149

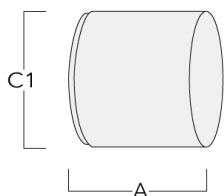

Electrical Accessories

Gear box

Description	Part ID	A	B	C1	C2	Weight (kg)
GB200 R200x120 gear box (medium)	139-2526	75	120	229	200	1.05

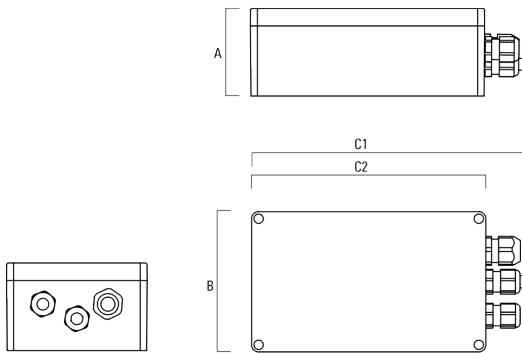

GB200 R230x140 gear box (large)	139-2527	95	140	259	230	1.20
---------------------------------	----------	----	-----	-----	-----	------

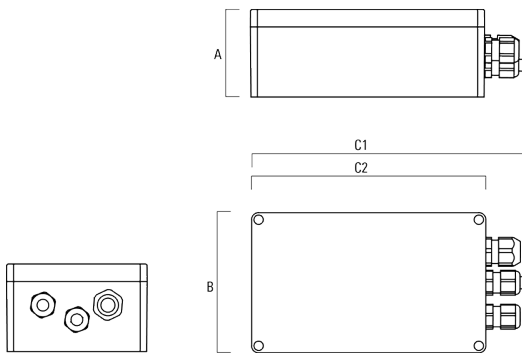

Mounting Accessories

Pole clamp PC

Description	Part ID	D1	Weight (kg)
PC2 76-89/60 Pole clamp, double (Ø 76-89)	139-2703	76-89	1.00

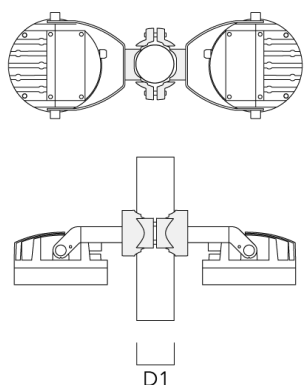

PC1 76-89/60 Pole clamp, single (Ø 76-89)	139-2702	76-89	1.00
---	----------	-------	------

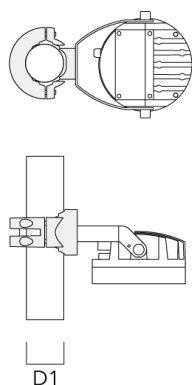

Projectors

Description	Part ID	D1	Weight (kg)
PC2 102-114/60 Pole clamp, double (Ø 102-114)	139-2707	102-114	1.20

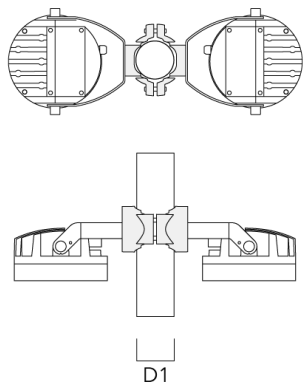

PC1 102-114/60 Pole clamp, single (Ø 102-114)	139-2706	102-114	1.20
--	----------	---------	------

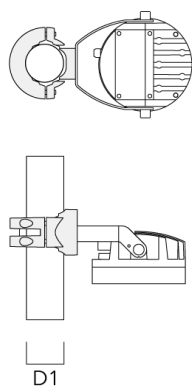

Projectors

Description	Part ID	D1	Weight (kg)
PC1 114-133/60 Pole clamp, single (Ø 114-133)	139-2708	114-133	1.40

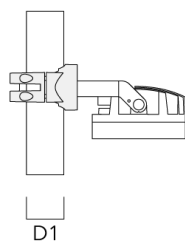
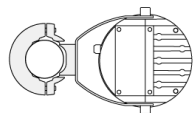

PC2 82-109/60 Pole camp, double (Ø 82-109)	139-2705	82-109	1.10
--	----------	--------	------

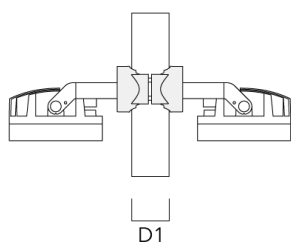
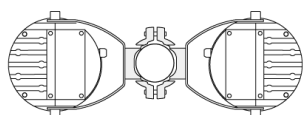

Projectors

Description	Part ID	D1	Weight (kg)
PC1 82-109/60 Pole camp, single (Ø 82-109)	139-2704	82-109	1.10

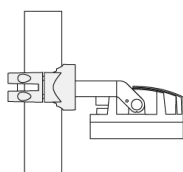
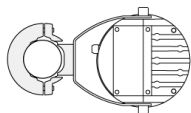

D1