

ZAT430-FT LED

Pole mounted

we-ef

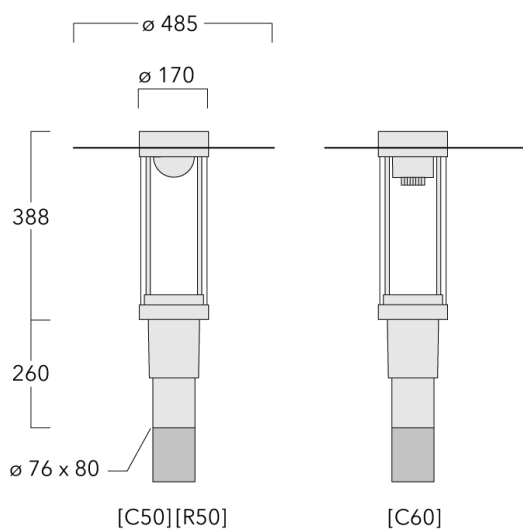

Description

IP66, Class I. Class II on request. IK09. Marine-grade, die-cast aluminium alloy. 5CE superior corrosion protection including PCS hardware. Silicone CCG® Controlled Compression Gasket. PMMA main lens. Integral EC electronic converter in thermally separated compartment. CAD-optimised indirect optics for superior illumination and glare control. Factory installed LED circuit board. The luminaire is factory-sealed and does not need to be opened during installation.

Fagerhult Lighting Ltd

33-34 Dolben Street, SE1 0UQ London, United Kingdom





<https://we-ef.com/uk>

Subject to technical changes and errors. - Generated on 23/11/2024

Pole mounted

Specifications

Material description

Body	Marine-grade, die-cast aluminium alloy
Lens	PMMA
Colours	 RAL9004 Signal black  RAL9006 White aluminium  RAL9007 Grey aluminium  RAL7016 Anthracite grey  RAL9016 Traffic white
Gasket	Silicone CCG® Controlled Compression Gasket
Fasteners	PCS Polymer Coated Stainless Steel Hardware
Ingress protection	IP66
Impact resistance	IK09
Corrosion resistance	5CE
Windage	0.130 m ²

Electrical description

Power supply	220-240V / 50-60 Hz
Driver / Ballast	Integral EC electronic converter
Power factor	> 0.9
Surge protection	6/6 kV (optional SP10)

Additional information

Lifetime	Ta=25° L70B50 > 50000h
Energy efficiency class	C-D (Light source)

ZAT430-FT LED

Pole mounted

we-ef

Options

Light distribution



controlled symmetric distribution [C50]



symmetric distribution [C60]



rectangular [R50]

Colour temperature



2700 K



3000 K



4000 K



Nominal Watt

24 W

2 W

42 W

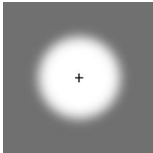
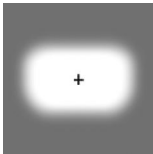
Configurations

Light distribution	Part ID	Light source	Rated lumens	Rated input power	CRI	Weight (kg)
controlled symmetric distribution [C50] 	115-1646	LED-FT-12W / 350 mA - 2700 K	1456.5	14 W	80	7.70
	115-1647	LED-FT-12W / 350 mA - 3000 K	1555.1	14 W	80	7.70
	115-1648	LED-FT-12W / 350 mA - 4000 K	1638.5	14 W	80	7.70
	115-1649	LED-FT-17W / 500 mA - 2700 K	2226.4	20 W	80	7.70
	115-1650	LED-FT-17W / 500 mA - 3000 K	2328.8	20 W	80	7.70
	115-1651	LED-FT-17W / 500 mA - 4000 K	2427.4	20 W	80	7.70
	115-1652	LED-FT-24W / 700 mA - 2700 K	3072.2	27 W	80	7.70
	115-1653	LED-FT-24W / 700 mA - 3000 K	3201.2	27 W	80	7.70
	115-1654	LED-FT-24W / 700 mA - 4000 K	3337.7	27 W	80	7.70
	115-1655	LED-FT-37W / 700 mA - 2700 K	4661.5	42 W	80	7.70
	115-1656	LED-FT-37W / 700 mA - 3000 K	4801.8	42 W	80	7.70
	115-1657	LED-FT-37W / 700 mA - 4000 K	4444.4	42 W	80	7.70
	rectangular [R50] 	115-1879	LED-FT-12W / 350 mA - 3000 K	1567.4	14 W	80
115-1880		LED-FT-12W / 350 mA - 4000 K	1651.5	14 W	80	7.70
115-1881		LED-FT-12W / 350 mA - 2700 K	1468	14 W	80	7.70
115-1882		LED-FT-24W / 700 mA - 3000 K	3226.6	27 W	80	7.70
115-1883		LED-FT-24W / 700 mA - 4000 K	3364.2	27 W	80	7.70
115-1884		LED-FT-24W / 700 mA - 2700 K	3096.6	27 W	80	7.70
115-1974		LED-FT-17W / 500 mA - 2700 K	2244.1	20 W	80	7.70
115-1975		LED-FT-17W / 500 mA - 3000 K	2347.3	20 W	80	7.70
115-1976		LED-FT-17W / 500 mA - 4000 K	2446.7	20 W	80	7.70
115-2080		LED-FT-37W / 700 mA - 3000 K	4839.8	42 W	80	7.70
115-2081		LED-FT-37W / 700 mA - 4000 K	5118.9	42 W	80	7.70
115-2082		LED-FT-37W / 700 mA - 2700 K	4698.4	42 W	80	7.70
symmetric distribution [C60] 		115-1658	LED-FT-12W / 350 mA - 2700 K	1274.6	14 W	80
	115-1659	LED-FT-12W / 350 mA - 3000 K	1360.9	14 W	80	7.70
	115-1660	LED-FT-12W / 350 mA - 4000 K	1433.9	14 W	80	7.70
	115-1661	LED-FT-17W / 500 mA - 2700 K	1948.4	20 W	80	7.70
	115-1662	LED-FT-17W / 500 mA - 3000 K	2038	20 W	80	7.70
	115-1663	LED-FT-17W / 500 mA - 4000 K	2124.3	20 W	80	7.70
	115-1664	LED-FT-24W / 700 mA - 2700 K	2688.6	27 W	80	7.70
	115-1665	LED-FT-24W / 700 mA - 3000 K	2801.4	27 W	80	7.70
	115-1666	LED-FT-24W / 700 mA - 4000 K	2920.9	27 W	80	7.70
	115-1667	LED-FT-37W / 700 mA - 2700 K	4079.3	42 W	80	7.70
	115-1668	LED-FT-37W / 700 mA - 3000 K	4202.1	42 W	80	7.70

ZAT430-FT LED

Pole mounted

we-ef

Light distribution	Part ID	Light source	Rated lumens	Rated input power	CRI	Weight (kg)
	115-1669	LED-FT-37W / 700 mA - 4000 K	4444.4	42 W	80	7.70

Fagerhult Lighting Ltd

33-34 Dolben Street, SE1 0UQ London, United Kingdom

<https://we-ef.com/uk>

Subject to technical changes and errors. - Generated on 23/11/2024

Pole mounted

Optical Accessories

Light shield

Description	Part ID	H1
LS180-[C60]	159-0321	120

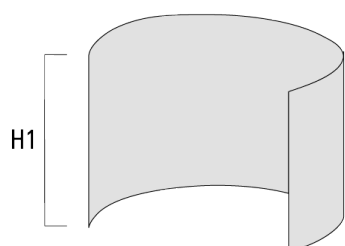

Pole mounted

Mounting Accessories

Wall and pole brackets RZ

Description	Part ID	C1	D1	D2	D × L1	M1	Weight (kg)
RZ0-400 Wall bracket, single	115-1324	277	231	195	76 x 80	12	3.50

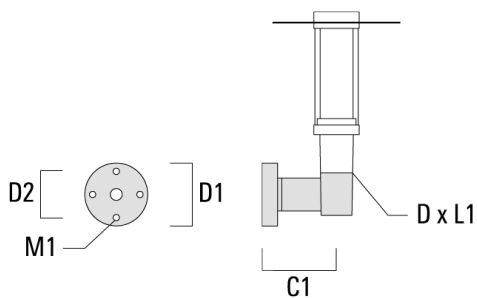

RZ2-400 Pole bracket, double	115-1323	258			76 x 100		4.90
------------------------------	----------	-----	--	--	----------	--	------

