

ZAT470-FT LED

Pole mounted

we-ef

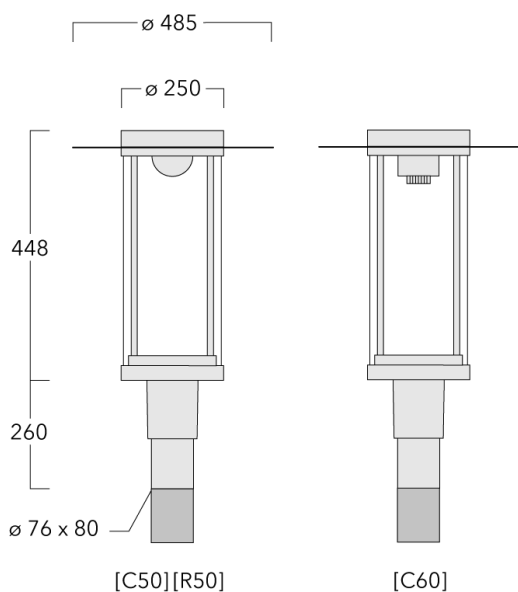

Description

IP66, Class I. Class II on request. IK08. Marine-grade, die-cast aluminium alloy. 5CE superior corrosion protection including PCS hardware. Silicone CCG® Controlled Compression Gasket. PMMA main lens. The luminaire is factory sealed and does not need to be opened during installation. Integral EC converter. DALI. Factory installed LED circuit board. Removable LED boards for upgrading. CAD-optimised indirect optics for superior illumination and glare control.

Fagerhult Lighting Ltd

33-34 Dolben Street, SE1 0UQ London, United Kingdom





<https://we-ef.com/uk>

Subject to technical changes and errors. - Generated on 24/11/2024

Pole mounted

Specifications

Material description

Body	Marine-grade, die-cast aluminium alloy
Lens	PMMA
Colours	 RAL9004 Signal black  RAL9006 White aluminium  RAL9007 Grey aluminium  RAL7016 Anthracite grey  RAL9016 Traffic white
Gasket	Silicone CCG® Controlled Compression Gasket
Fasteners	PCS Polymer Coated Stainless Steel Hardware
Ingress protection	IP66
Impact resistance	IK08
Corrosion resistance	5CE
Windage	0.205 m ²

Electrical description

Power supply	220-240V / 50-60 Hz
Driver / Ballast	Integral EC electronic converter. DALI
Power factor	> 0.9
Surge protection	6/6 kV (optional SP10)

Additional information

Lifetime	Ta=25° L70B50 > 50000h
Energy efficiency class	C-D (Light source)

ZAT470-FT LED

Pole mounted

we-ef

Options

Light distribution



controlled symmetric distribution [C50]



symmetric distribution [C60]



rectangular [R50]

Colour temperature



2700 K



3000 K





4000 K

Nominal Watt

24 W

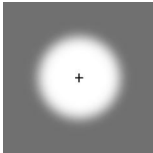
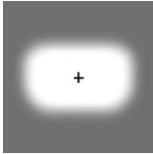
Configurations

Light distribution	Part ID	Light source	Rated lumens	Rated input power	CRI	Weight (kg)
controlled symmetric distribution [C50] 	115-1754	LED-FT-24W / 700 mA - 2700 K	3312.3	27 W	80	9.90
	115-1755	LED-FT-24W / 700 mA - 3000 K	3451.4	27 W	80	9.90
	115-1756	LED-FT-24W / 700 mA - 4000 K	3598.6	27 W	80	9.90
	115-1757	LED-FT-37W / 700 mA - 2700 K	5025.8	42 W	80	9.90
	115-1758	LED-FT-37W / 700 mA - 3000 K	5177.1	42 W	80	9.90
	115-1759	LED-FT-37W / 700 mA - 4000 K	5475.6	42 W	80	9.90
rectangular [R50] 	115-1897	LED-FT-24W / 700 mA - 3000 K	3335	27 W	80	9.90
	115-1898	LED-FT-24W / 700 mA - 4000 K	3477.3	27 W	80	9.90
	115-1899	LED-FT-24W / 700 mA - 2700 K	3200.7	27 W	80	9.90
	115-1900	LED-FT-37W / 700 mA - 3000 K	5002.5	42 W	80	9.90
	115-1901	LED-FT-37W / 700 mA - 4000 K	5291	42 W	80	9.90
	115-1902	LED-FT-37W / 700 mA - 2700 K	4856.3	42 W	80	9.90
symmetric distribution [C60] 	115-1760	LED-FT-24W / 700 mA - 2700 K	3033.6	27 W	80	9.90
	115-1761	LED-FT-24W / 700 mA - 3000 K	3160.9	27 W	80	9.90
	115-1762	LED-FT-24W / 700 mA - 4000 K	3295.7	27 W	80	9.90
	115-1763	LED-FT-37W / 700 mA - 2700 K	4602.8	42 W	80	9.90
	115-1764	LED-FT-37W / 700 mA - 3000 K	4741.3	42 W	80	9.90
	115-1765	LED-FT-37W / 700 mA - 4000 K	5014.7	42 W	80	9.90

Pole mounted

Optical Accessories

Light shield

Description	Part ID	H1
LS180-[C60]	159-0321	120

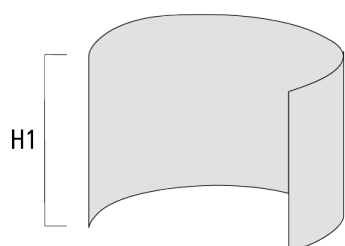

Pole mounted

Mounting Accessories

Wall and pole brackets RZ

Description	Part ID	C1	D1	D2	D × L1	M1	Weight (kg)
RZ0-400 Wall bracket, single	115-1324	277	231	195	76 x 80	12	3.50

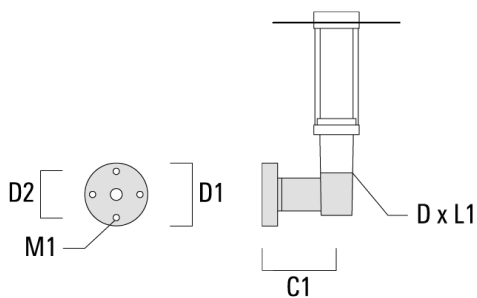

RZ2-400 Pole bracket, double	115-1323	258			76 x 100		4.90
------------------------------	----------	-----	--	--	----------	--	------

