

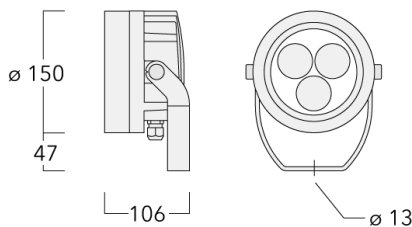



**Description**

IP66, Class I. IK07. Marine-grade, die-cast aluminium alloy. 5CE superior corrosion protection + primer including PCS hardware. Silicone CCG® Controlled Compression Gasket. Safety glass lens. One cable gland. Second gland for through wiring on request. Integral EC electronic converter, thermally separated. CAD-optimised optics for superior illumination and glare control. OLC® One LED Concept. Factory installed LED circuit board. DALI Interface. Eco Step Dim® on request. Maximum one internal optical accessory possible.



Specifications**Material description**

Body	Marine-grade, die-cast aluminium alloy
Lens	Safety glass lens
Colours	 RAL9004 Signal black  RAL9006 White aluminium  RAL9007 Grey aluminium
Gasket	Silicone CCG® Controlled Compression Gasket
Fasteners	PCS Polymer Coated Stainless Steel Hardware
Ingress protection	IP66
Impact resistance	IK07
Corrosion resistance	5CE+Primer
Windage	0.018 m ²

Electrical description

Power supply	230V / 50 Hz
Driver / Ballast	Integral EC electronic convertor in thermally-separated compartment

Additional information

Lifetime	Ta=40° L90B10 > 90000h
Warranty	The product is supplied with 10-year warranty. Please refer to the LED Warranty Statement located on www.we-ef.com for further details.

Options

Light distribution



symmetric, wide beam [B]



symmetric, medium beam [M]



symmetric, narrow beam [E]



symmetric, very narrow beam [EE]



symmetric, very narrow beam, sharp cut-off [EES]



linear spread, very narrow beam [EE]



linear spread, very narrow beam, sharp cut-off [EES]

Colour temperature



2700 K



3000 K





4000 K

Nominal Watt

0 W

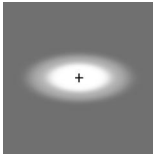
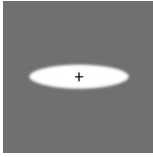
Configurations

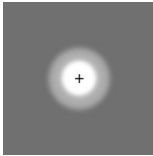
Light distribution	Part ID	Light source	Rated lumens	Rated input power	CRI	Weight (kg)
linear spread, very narrow beam [EE] 	139-2368+139-2404	LED-3/6W / 180 mA - 3000 K	621.2	7.5 W	80	2.00
	139-2369+139-2404	LED-3/6W / 180 mA - 4000 K	669	7.5 W	80	2.00
	139-2370+139-2404	LED-3/6W / 180 mA - 2700 K	621.2	7.5 W	80	2.00
	139-2383+139-2404	LED-3/9W / 250 mA - 3000 K	872	11 W	80	2.00
	139-2384+139-2404	LED-3/9W / 250 mA - 4000 K	931.8	11 W	80	2.00
	139-2385+139-2404	LED-3/9W / 250 mA - 2700 K	872	11 W	80	2.00
	139-2398+139-2404	LED-3/12W / 350 mA - 3000 K	1170.7	13.9 W	80	2.00
	139-2399+139-2404	LED-3/12W / 350 mA - 4000 K	1266.3	13.9 W	80	2.00
	139-2400+139-2404	LED-3/12W / 350 mA - 2700 K	1170.7	13.9 W	80	2.00
linear spread, very narrow beam, sharp cut-off [EES] 	139-2371+139-2404	LED-3/6W / 180 mA - 3000 K	559.4	7.5 W	80	2.00
	139-2372+139-2404	LED-3/6W / 180 mA - 4000 K	606	7.5 W	80	2.00
	139-2373+139-2404	LED-3/6W / 180 mA - 2700 K	559.4	7.5 W	80	2.00
	139-2386+139-2404	LED-3/9W / 250 mA - 3000 K	792.5	11 W	80	2.00
	139-2388+139-2404	LED-3/9W / 250 mA - 2700 K	792.5	11 W	80	2.00
	139-2401+139-2404	LED-3/12W / 350 mA - 3000 K	1060.5	13.9 W	80	2.00
	139-2402+139-2404	LED-3/12W / 350 mA - 4000 K	1142.1	13.9 W	80	2.00
	139-2403+139-2404	LED-3/12W / 350 mA - 2700 K	1060.5	13.9 W	80	2.00
symmetric, medium beam [M] 	139-2362	LED-3/6W / 180 mA - 3000 K	684.1	7.5 W	80	2.00
	139-2363	LED-3/6W / 180 mA - 4000 K	736.8	7.5 W	80	2.00
	139-2364	LED-3/6W / 180 mA - 2700 K	684.1	7.5 W	80	2.00
	139-2377	LED-3/9W / 250 mA - 3000 K	960.4	11 W	80	2.00
	139-2378	LED-3/9W / 250 mA - 4000 K	1026.2	11 W	80	2.00
	139-2379	LED-3/9W / 250 mA - 2700 K	960.4	11 W	80	2.00
	139-2392	LED-3/12W / 350 mA - 3000 K	1289.4	13.9 W	80	2.00
	139-2393	LED-3/12W / 350 mA - 4000 K	1394.6	13.9 W	80	2.00
	139-2394	LED-3/12W / 350 mA - 2700 K	1289.4	13.9 W	80	2.00
	symmetric, narrow beam [E] 	139-2365	LED-3/6W / 180 mA - 3000 K	629.9	7.5 W	80
139-2366		LED-3/6W / 180 mA - 4000 K	678.3	7.5 W	80	2.00
139-2367		LED-3/6W / 180 mA - 2700 K	629.9	7.5 W	80	2.00
139-2380		LED-3/9W / 250 mA - 3000 K	884.2	11 W	80	2.00
139-2381		LED-3/9W / 250 mA - 4000 K	944.8	11 W	80	2.00
139-2382		LED-3/9W / 250 mA - 2700 K	884.2	11 W	80	2.00
139-2395		LED-3/12W / 350 mA - 3000 K	1187.1	13.9 W	80	2.00
139-2396		LED-3/12W / 350 mA - 4000 K	1284	13.9 W	80	2.00
139-2397		LED-3/12W / 350 mA - 2700 K	1187.1	13.9 W	80	2.00

Projectors

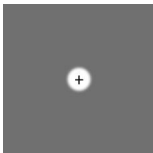
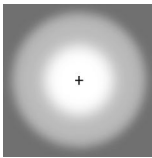
Light distribution	Part ID	Light source	Rated lumens	Rated input power	CRI	Weight (kg)
symmetric, very narrow beam [EE] 	139-2368	LED-3/6W / 180 mA - 3000 K	693.2	7.5 W	80	2.00
	139-2369	LED-3/6W / 180 mA - 4000 K	746.5	7.5 W	80	2.00
	139-2370	LED-3/6W / 180 mA - 2700 K	693.2	7.5 W	80	2.00
	139-2383	LED-3/9W / 250 mA - 3000 K	973.1	11 W	80	2.00
	139-2384	LED-3/9W / 250 mA - 4000 K	1039.8	11 W	80	2.00
	139-2385	LED-3/9W / 250 mA - 2700 K	973.1	11 W	80	2.00
	139-2398	LED-3/12W / 350 mA - 3000 K	1306.4	13.9 W	80	2.00
	139-2399	LED-3/12W / 350 mA - 4000 K	1413	13.9 W	80	2.00
	139-2400	LED-3/12W / 350 mA - 2700 K	1306.4	13.9 W	80	2.00
	symmetric, very narrow beam, sharp cut-off [EES] 	139-2371	LED-3/6W / 180 mA - 3000 K	624.8	7.5 W	80
139-2372		LED-3/6W / 180 mA - 4000 K	676.8	7.5 W	80	2.00
139-2373		LED-3/6W / 180 mA - 2700 K	624.8	7.5 W	80	2.00
139-2386		LED-3/9W / 250 mA - 3000 K	885.1	11 W	80	2.00
139-2387		LED-3/9W / 250 mA - 4000 K	950.2	11 W	80	2.00
139-2388		LED-3/9W / 250 mA - 2700 K	885.1	11 W	80	2.00
139-2401		LED-3/12W / 350 mA - 3000 K	1184.4	13.9 W	80	2.00
139-2402		LED-3/12W / 350 mA - 4000 K	1275.6	13.9 W	80	2.00
139-2403		LED-3/12W / 350 mA - 2700 K	1184.4	13.9 W	80	2.00
symmetric, wide beam [B] 		139-2359	LED-3/6W / 180 mA - 3000 K	643.3	7.5 W	80
	139-2360	LED-3/6W / 180 mA - 4000 K	692.8	7.5 W	80	2.00
	139-2361	LED-3/6W / 180 mA - 2700 K	643.3	7.5 W	80	2.00
	139-2374	LED-3/9W / 250 mA - 3000 K	903.1	11 W	80	2.00
	139-2375	LED-3/9W / 250 mA - 4000 K	965	11 W	80	2.00
	139-2376	LED-3/9W / 250 mA - 2700 K	903.1	11 W	80	2.00
	139-2389	LED-3/12W / 350 mA - 3000 K	1212.4	13.9 W	80	2.00
	139-2390	LED-3/12W / 350 mA - 4000 K	1311.4	13.9 W	80	2.00
	139-2391	LED-3/12W / 350 mA - 2700 K	1212.4	13.9 W	80	2.00

Control**1-10 V analogue dimming interface**

Description	Part ID	C
1-10 V analogue dimming interface	430-0011	90

DALI interface

Description	Part ID	Additional information
DALI interface	430-0013	DALI variant. The luminaire is equipped with a DT6 Dali driver (Dali 2.0). Dali 2.0 -Application controllers and Input devices defined -Single-masters and multi-masters allowed -Event priorities defined -Separate addressing & grouping from control gear Note: Mixing Dali 1 and Dali 2.0 drivers can cause problems because the addressing and the command scope has changed!

Optical Accessories

Linear spread lens

Description	Part ID	C1
IO-180-FLC210-LED	139-2404	100

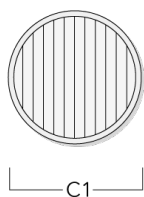

Honeycomb louvre

Description	Part ID	C1
IW-FLC210-LED	139-2405	100

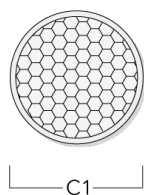

Projectors**Glare shield**

Description	Part ID	A	C1
ES-FLC210-LED	139-2406	86	149

Snoot

Description	Part ID	A	C1
ET-FLC210-LED	139-2407	86	149

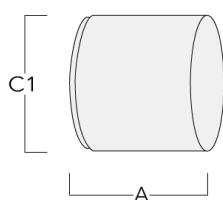

Mounting Accessories

Pole clamp PC - Rotatable

Description	Part ID	D1	Weight (kg)
PC2 76-89/60 Pole clamp, double (Ø 76-89)	139-2703	76-89	1.00

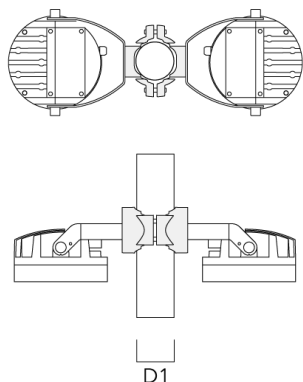

PC1 76-89/60 Pole clamp, single (Ø 76-89)	139-2702	76-89	1.00
---	----------	-------	------

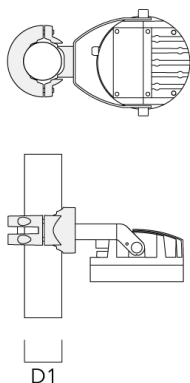

Description	Part ID	D1	Weight (kg)
PC2 102-114/60 Pole clamp, double (Ø 102-114)	139-2707	102-114	1.20



PC1 102-114/60 Pole clamp, single (Ø 102-114)	139-2706	102-114	1.20
--	----------	---------	------



Description	Part ID	D1	Weight (kg)
PC2 114-133/60 Pole clamp, double (Ø 114-133)	139-2709	114-133	1.40

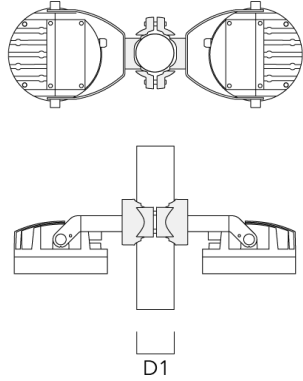

PC1 114-133/60 Pole clamp, single (Ø 114-133)	139-2708	114-133	1.40
--	----------	---------	------

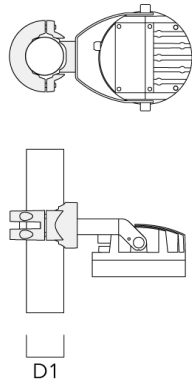

Description	Part ID	D1	Weight (kg)
PC2 82-109/60 Pole camp, double (Ø 82-109)	139-2705	82-109	1.10

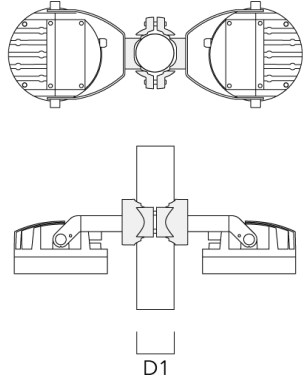

PC1 82-109/60 Pole camp, single (Ø 82-109)	139-2704	82-109	1.10
--	----------	--------	------

