





### Description

Tunable White. IP66, Class III. IK07. Marine-grade, die-cast aluminium alloy. 5CE superior corrosion protection including PCS hardware. Silicone CCG® Controlled Compression Gasket. Safety glass lens. Electronic control gear in separate gear box (constant current), prewired. Gearbox to be ordered separately. One factory installed flange plug M8 x 1.5. Cable length 10 ft. CAD-optimised optics for superior illumination and glare control. Factory-installed LED circuit board. Tunable White Technology. DALI interface.

Maximum one internal optical accessory possible. To be specified at time of ordering.

**Projectors****Specifications****Material description**

---

Body	Marine-grade, die-cast aluminium alloy
Lens	Safety glass lens
Colours	 RAL9004 Signal black  RAL9006 White aluminium  RAL9007 Grey aluminium  RAL7016 Anthracite grey  RAL9016 Traffic white
Gasket	Silicone CCG® Controlled Compression Gasket
Fasteners	PCS Polymer Coated Stainless Steel Hardware
Ingress protection	IP66
Impact resistance	IK07
Corrosion resistance	5CE
Windage	0.065 ft <sup>2</sup>

---

**Electrical description**

---

Power supply	220-240V / 50-60 Hz
Driver / Ballast	DALI
Power factor	> 0.9

---

**Additional information**

---

Lifetime	Ta=25° L90B10 > 90000h
Energy efficiency class	D (Light source)

---

# FLC201-TW LED

## Projectors

### Options

#### Light distribution



symmetric, wide beam [B]



symmetric, medium beam [M]



symmetric, narrow beam [E]



#### Colour temperature

2200-6000K

#### Nominal Watt

0 W

### Configurations

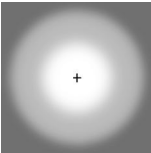
Light distribution	Part ID	Light source	Rated lumens	Rated input power	CRI	Weight (kg)
symmetric, medium beam [M] 	139-2451	LED-1/4W - 2200-6000 K	321.1	5.5 W	80	0.50
symmetric, narrow beam [E] 	139-2452	LED-1/4W - 2200-6000 K	326.9	5.5 W	80	0.50
symmetric, wide beam [B] 	139-2450	LED-1/4W - 2200-6000 K	317.8	5.5 W	80	0.50

**Optical Accessories****Linear spread lens**

---

Description	Part ID	C1
IO-180-FLC201-LED	139-2453	41.8

---



---

**Honeycomb louvre**

---

Description	Part ID	C1
IW-FLC201-LED - [EE][EES]	139-2454	48

---

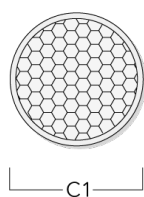

## Projectors

### Glare shield

Description	Part ID	A	C1
ES-FLC201-LED	139-2455	59.5	75

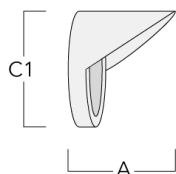

### Snoot

Description	Part ID	A	C1
ET-FLC201-LED	139-2456	60	75

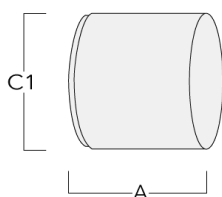

### Mounting Accessories

#### Junction box

Description	Part ID	A	B	C1	C2
JB200 R82 Junction box	139-2590	55	82	140	80

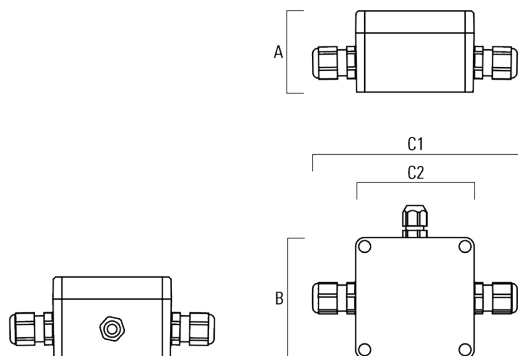

### Electrical Accessories

#### Gear box

Description	Part ID	A	B	C1	C2
GB200 R200x120 gear box (medium) TW	139-2632	75	120	229	200

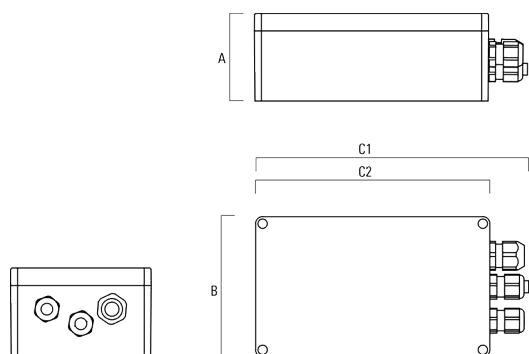

GB200 R230x140 gear box (large) SP10 TW	139-2633	95	140	255	230
--------------------------------------------	----------	----	-----	-----	-----

