

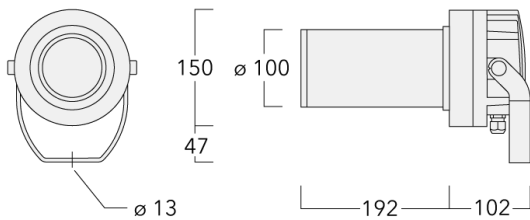

### Description





RGBW/RGBA Colour Changer Profile Projector [FP] for framing applications, polygon shape. Spherical and aspherical, double flat convex lens system.



IP66, Class III. IK05. Marine-grade, die-cast aluminium alloy. 5CE superior corrosion protection including PCS hardware. Silicone CCG<sup>®</sup> Controlled Compression Gasket. Safety glass lens. One cable gland. Second gland for through wiring on request. Electronic control gear in separate gearbox (medium), prewired. Glass LED lens array. Factory installed LED circuit board. DMX interface.

**Projectors****Specifications****Material description**

---

Body	Marine-grade, die-cast aluminium alloy
Lens	Safety glass lens
Colours	 RAL9004 Signal black  RAL9006 White aluminium  RAL9007 Grey aluminium  RAL7016 Anthracite grey  RAL9016 Traffic white
Gasket	Silicone CCG® Controlled Compression Gasket
Fasteners	PCS Polymer Coated Stainless Steel Hardware
Ingress protection	IP66
Impact resistance	IK05
Corrosion resistance	5CE

---

**Electrical description**

---

Power supply	220-240V / 50-60 Hz
Driver / Ballast	DMX (separate gearbox)
Power factor	> 0.9
Surge protection	6/6 kV (optional SP10 in separate gearbox, large)

---

**Additional information**

---

Lifetime	Ta=25° L70B50 > 50000h
Energy efficiency class	G (Light source)

---

# FLC210-CC LED [FP]

## Projectors

**we-ef**

### Options

#### Light distribution



symmetric Framing-Projector [FP] - min aperture angle



symmetric Framing-Projector [FP] - max aperture angle

#### Colour temperature

RGBW/4K

RGBA

#### Nominal Watt

0 W

#### Fagerhult Lighting Ltd

33-34 Dolben Street, SE1 0UQ London, United Kingdom

<https://we-ef.com/uk>

Subject to technical changes and errors. - Generated on 23/10/2024

### Configurations

Light distribution	Part ID	Light source	Rated lumens	Rated input power	CRI	Weight (kg)
symmetric Framing-Projector [FP] - max aperture angle	139-2490_max	LED-FT-15W - RGBW/4K	500.6	17 W	20/80	4.00
	139-2491_max	LED-FT-15W - RGBA	429.1	17 W	20	4.00
symmetric Framing-Projector [FP] - min aperture angle	139-2490_min	LED-FT-15W - RGBW/4K	333.5	17 W	20/80	4.00
	139-2491_min	LED-FT-15W - RGBA	285.9	17 W	20	4.00



**Electrical Accessories**

**Gear box**

Description	Part ID	A	B	C1	C2	Weight (kg)
GB200 R200x120 gear box (medium)	139-2526	75	120	229	200	1.05

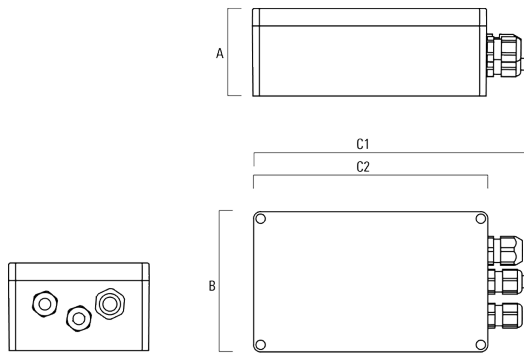

GB200 R230x140 gear box (large)	139-2527	95	140	259	230	1.20
---------------------------------	----------	----	-----	-----	-----	------

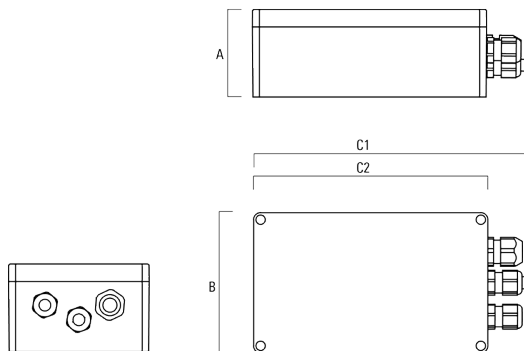

### Mounting Accessories

#### Pole clamp PC

Description	Part ID	D1	Weight (kg)
PC1 76-89/60 Pole clamp, single (Ø 76-89)	139-2702	76-89	1.00

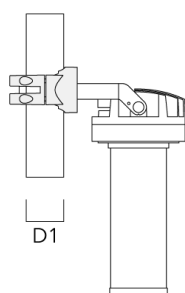
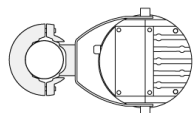

PC2 76-89/60 Pole clamp, double (Ø 76-89)	139-2703	76-89	1.00
---	----------	-------	------

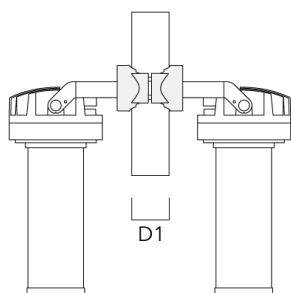
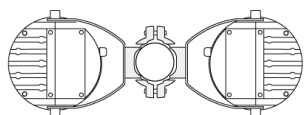

## Projectors

Description	Part ID	D1	Weight (kg)
PC2 82-109/60 Pole clamp, double (Ø 82-109)	139-2705	82-109	1.10

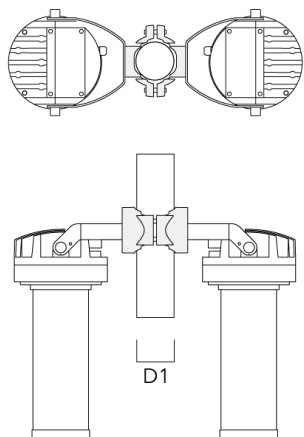

PC1 102-114/60 Pole clamp, single (Ø 102-114)	139-2706	102-114	1.20
--	----------	---------	------

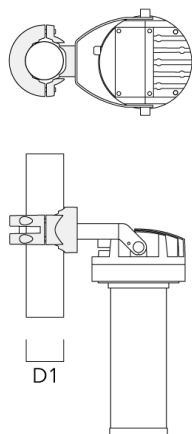

## Projectors

Description	Part ID	D1	Weight (kg)
PC2 102-114/60 Pole clamp, double (Ø 102-114)	139-2707	102-114	1.20

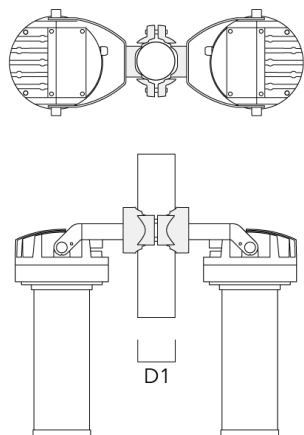

PC1 114-133/60 Pole clamp, single (Ø 114-133)	139-2708	114-133	1.40
--	----------	---------	------

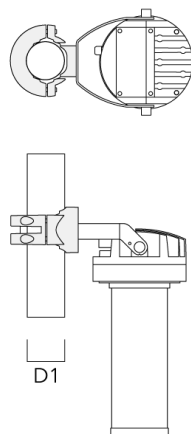



## Projectors

---

Description	Part ID	D1	Weight (kg)
PC2 114-133/60 Pole clamp, double (Ø 114-133)	139-2709	114-133	1.40

---

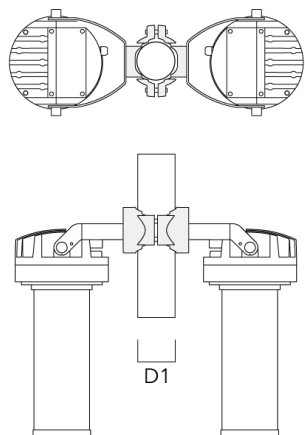

**FLC210-CC LED [FP]**

**Projectors**

**Fagerhult Lighting Ltd**

33-34 Dolben Street, SE1 0UQ London, United Kingdom

<https://we-ef.com/uk>

Subject to technical changes and errors.

Generated on 23/10/2024