





Description

Profile Projector [ZP] for zoom spot. Spherical and aspherical, double flat convex lens system.

IP66, Class I. IK05. Marine-grade, die-cast aluminium alloy. 5CE superior corrosion protection including PCS hardware. Silicone CCG® Controlled Compression Gasket. Safety glass lens. One cable gland. Second gland for through wiring on request.

Integral EC electronic converter in thermally-separated compartment. Glass LED lens array. Factory installed LED circuit board.

Projectors**Specifications****Material description**

Body	Marine-grade, die-cast aluminium alloy
Lens	Safety glass lens
Colours	 RAL9004 Signal black  RAL9007 Grey aluminium  RAL7016 Anthracite grey  RAL9016 Traffic white
Gasket	Silicone CCG® Controlled Compression Gasket
Fasteners	PCS Polymer Coated Stainless Steel Hardware
Ingress protection	IP66
Impact resistance	IK05
Corrosion resistance	5CE

Electrical description

Driver / Ballast	Integral EC electronic converter in thermally-separated compartment
Power factor	> 0.9

Additional information

Lifetime	Ta=25° L70B50 > 50000h
----------	------------------------

FLC210 LED [ZP]

Projectors

we-ef

Options

Light distribution



symmetric Zoom-Projector [ZP] - min aperture angle



symmetric Zoom-Projector [ZP] - max aperture angle

Colour temperature



2700 K



3000 K





4000 K

Nominal Watt

0 W

Configurations

Light distribution	Part ID	Light source	Rated lumens	Rated input power	CRI	Weight (kg)
symmetric Zoom-Projector [ZP] - max aperture angle 	139-2477_max	LED-FT-26W - 3000 K	1827.3	28 W	80	4.00
	139-2478_max	LED-FT-26W - 4000 K	1924.3	28 W	80	4.00
	139-2496_max	LED-FT-18W - 3000 K	1330.9	20 W	80	4.00
	139-2497_max	LED-FT-18W - 4000 K	1403	20 W	80	4.00
	139-2502_max	LED-FT-18W - 2700 K	1286.6	20 W	80	4.00
	139-2505_max	LED-FT-26W - 2700 K	1769	28 W	80	4.00
symmetric Zoom-Projector [ZP] - min aperture angle 	139-2477_min	LED-FT-26W - 3000 K	1690.6	28 W	80	4.00
	139-2478_min	LED-FT-26W - 4000 K	1780.3	28 W	80	4.00
	139-2496_min	LED-FT-18W - 3000 K	1231.4	20 W	80	4.00
	139-2497_min	LED-FT-18W - 4000 K	1298.1	20 W	80	4.00
	139-2502_min	LED-FT-18W - 2700 K	1190.3	20 W	80	4.00
	139-2505_min	LED-FT-26W - 2700 K	1636.7	28 W	80	4.00

Mounting Accessories

Pole clamp PC - Rotatable

Description	Part ID	D1	Weight (kg)
PC1 76-89/60 Pole clamp, single (Ø 76-89)	139-2702	76-89	1.00

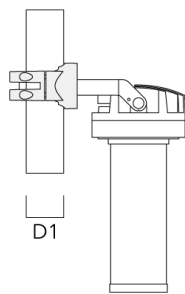
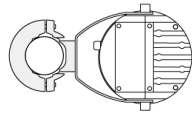

PC2 76-89/60 Pole clamp, double (Ø 76-89)	139-2703	76-89	1.00
---	----------	-------	------

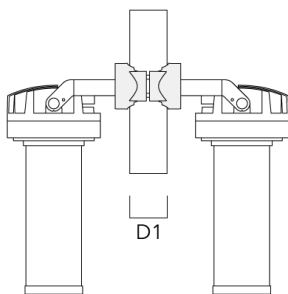
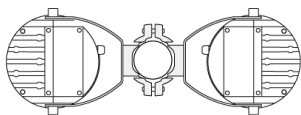

Projectors

Description	Part ID	D1	Weight (kg)
PC2 82-109/60 Pole clamp, double (Ø 82-109)	139-2705	82-109	1.10

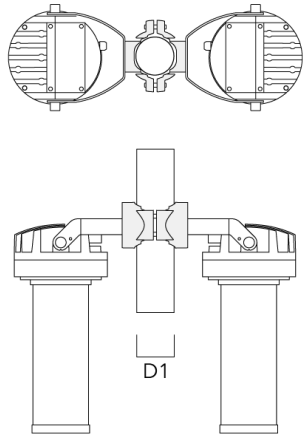

PC1 102-114/60 Pole clamp, single (Ø 102-114)	139-2706	102-114	1.20
--	----------	---------	------



Projectors

Description	Part ID	D1	Weight (kg)
PC2 102-114/60 Pole clamp, double (Ø 102-114)	139-2707	102-114	1.20



PC1 114-133/60 Pole clamp, single (Ø 114-133)	139-2708	114-133	1.40
--	----------	---------	------



Projectors

Description	Part ID	D1	Weight (kg)
PC2 114-133/60 Pole clamp, double (Ø 114-133)	139-2709	114-133	1.40

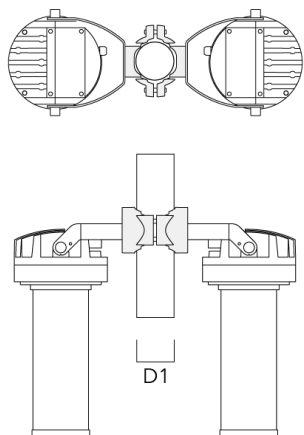

FLC210 LED [ZP]

Projectors

WE-EF LIGHTING (Thailand) Co., Ltd.

57 Moo 5, Kingkaew Rd., Bangplee, 10540 Samutprakarn

Phone: +66 2 738 96 20

Fax: +66 2 738 96 29

<https://we-ef.com/asia>

Subject to technical changes and errors.

Generated on 23/10/2024