



### Description

Profile Projector [FP] for framing applications, polygon shape. Spherical and aspherical, double flat convex lens system.

IP66, Class I. IK05. Marine-grade, die-cast aluminium alloy. 5CE superior corrosion protection including PCS hardware. Silicone CCG® Controlled Compression Gasket. Safety glass lens. One cable gland. Second gland for through wiring on request. Glass LED lens array. Factory installed LED circuit board. Integral electronic control gear, thermally separated.

**Projectors****Specifications****Material description**

---

Body	Marine-grade, die-cast aluminium alloy
Lens	Safety glass lens
Colours	 RAL9004 Signal black  RAL9006 White aluminium  RAL9007 Grey aluminium
Gasket	Silicone CCG® Controlled Compression Gasket
Fasteners	PCS Polymer Coated Stainless Steel Hardware
Ingress protection	IP66
Impact resistance	IK05
Corrosion resistance	5CE

---

**Electrical description**

---

Driver / Ballast	Integral EC electronic converter in thermally-separated compartment
Power factor	> 0.9

---

**Additional information**

---

Lifetime	Ta=40° L70B50 > 50000h
----------	------------------------

---

# FLC210 LED [FP]

## Projectors

**we-ef**

### Options

#### Light distribution



symmetric Framing-Projector [FP] - min aperture angle



symmetric Framing-Projector [FP] - max aperture angle

#### Colour temperature



2700 K



3000 K

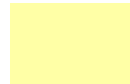

4000 K

#### Nominal Watt

0 W



#### WE-EF LIGHTING Pty Ltd

6/13 Downard Street, 3195 Braeside, Victoria - Phone: +61 3 8587 0444 - Fax: +61 3 8587 0499

info.australia@we-ef.com - <https://we-ef.com/aus>

Subject to technical changes and errors. - Generated on 23/11/2024

### Configurations

Light distribution	Part ID	Light source	Rated lumens	Rated input power	CRI	Weight (kg)
symmetric Framing-Projector [FP] - max aperture angle 	139-2475_max	LED-FT-18W - 3000 K	1330.9	20 W	80	4.00
	139-2476_max	LED-FT-18W - 4000 K	1403	20 W	80	4.00
	139-2481_max	LED-FT-26W - 3000 K	1827.3	28 W	80	4.00
	139-2482_max	LED-FT-26W - 4000 K	1924.3	28 W	80	4.00
	139-2504_max	LED-FT-18W - 2700 K	1286.6	20 W	80	4.00
	139-2507_max	LED-FT-26W - 2700 K	1769	28 W	80	4.00
symmetric Framing-Projector [FP] - min aperture angle 	139-2475_min	LED-FT-18W - 3000 K	1231.4	20 W	80	4.00
	139-2476_min	LED-FT-18W - 4000 K	1298.1	20 W	80	4.00
	139-2481_min	LED-FT-26W - 3000 K	1690.6	28 W	80	4.00
	139-2482_min	LED-FT-26W - 4000 K	1780.3	28 W	80	4.00
	139-2504_min	LED-FT-18W - 2700 K	1190.3	20 W	80	4.00
	139-2507_min	LED-FT-26W - 2700 K	1636.7	28 W	80	4.00

**Mounting Accessories**

**Pole clamp PC - Rotatable**

Description	Part ID	D1	Weight (kg)
PC2 76-89/60 Pole clamp, double (Ø 76-89)	139-2703	76-89	1.00

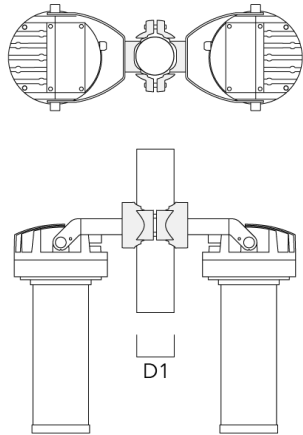

PC2 82-109/60 Pole clamp, double (Ø 82-109)	139-2705	82-109	1.10
---	----------	--------	------

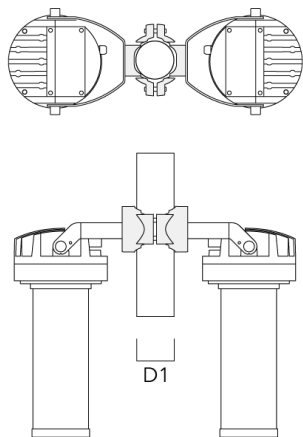

## Projectors

Description	Part ID	D1	Weight (kg)
PC2 102-114/60 Pole clamp, double (Ø 102-114)	139-2707	102-114	1.20

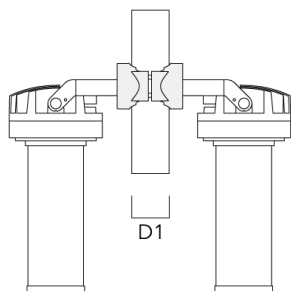
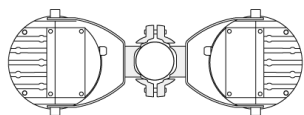

PC1 114-133/60 Pole clamp, single (Ø 114-133)	139-2708	114-133	1.40
--	----------	---------	------

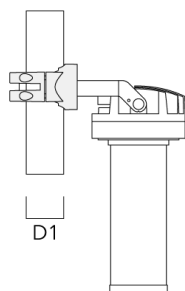
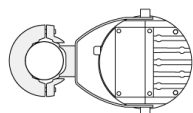

## Projectors

---

Description	Part ID	D1	Weight (kg)
PC2 114-133/60 Pole clamp, double (Ø 114-133)	139-2709	114-133	1.40

---

