

Description

IP66. IK07. Marine-grade, die-cast aluminium alloy. 5CE superior corrosion protection including PCS hardware. Safety glass lens. Silicone CCG® Controlled Compression Gasket. Luminaire is factory-sealed and does not need to be opened during installation. Knuckle permits 340° rotation, forward tilt 73° and backward tilt 90°.





Advanced thermal management protects LEDs while optimising lumens output. CAD-optimised optics for superior illumination and glare control. Including 1.5 m of flexible PVC free cable.

Mains voltage versions, ON-OFF Class I. Integral EC electronic converter.

Optical accessories are factory-installed. To be specified at time of ordering.

Specifications

Material description

Body	Marine-grade, die-cast aluminium alloy
Lens	Safety glass lens
Colours	 RAL9004 Signal black  RAL9006 White aluminium  RAL9007 Grey aluminium  RAL7016 Anthracite grey  RAL9016 Traffic white
Gasket	Silicone CCG® Controlled Compression Gasket
Fasteners	PCS hardware
Ingress protection	IP66
Impact resistance	IK07
Corrosion resistance	5CE
Windage	0.015 m ²

Electrical description

Driver / Ballast	Integral EC electronic converter
Power factor	>0.9

Additional information

Lifetime	Ta=25° L90B10 > 90000h
Energy efficiency class	D-E (Light source)

FLC301 Spigot mounted

Projectors

we-ef

Options

Light distribution



symmetric, wide beam [B]



symmetric, medium beam [M]



symmetric, narrow beam [E]



symmetric, very narrow beam [EE]



symmetric, very narrow beam, sharp cut-off [EES]



linear spread, very narrow beam [EE]



linear spread, very narrow beam, sharp cut-off [EES]



wallwash

Colour temperature



2700 K



3000 K





4000 K

Nominal Watt

0 W

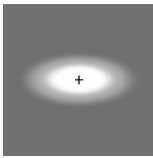
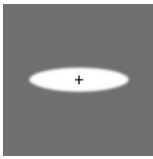
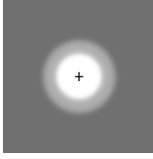
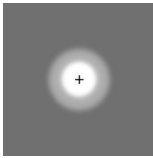
Configurations

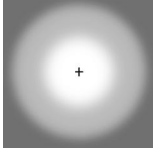
Light distribution	Part ID	Light source	Rated lumens	Rated input power	CRI	Weight (kg)
linear spread, very narrow beam [EE] 	145-7186+145-7229	LED-1/4W / 350 mA - 2700 K	384.7	5 W	80	0.70
	145-7187+145-7229	LED-1/4W / 350 mA - 3000 K	384.7	5 W	80	0.70
	145-7188+145-7229	LED-1/4W / 350 mA - 4000 K	416.1	5 W	80	0.70
linear spread, very narrow beam, sharp cut-off [EES] 	145-7189+145-7229	LED-1/4W / 350 mA - 2700 K	343.5	5 W	80	0.70
	145-7190+145-7229	LED-1/4W / 350 mA - 3000 K	343.5	5 W	80	0.70
	145-7191+145-7229	LED-1/4W / 350 mA - 4000 K	369.9	5 W	80	0.70
symmetric, medium beam [M] 	145-7183	LED-1/4W / 350 mA - 2700 K	398.4	5 W	80	0.70
	145-7184	LED-1/4W / 350 mA - 3000 K	398.4	5 W	80	0.70
	145-7185	LED-1/4W / 350 mA - 4000 K	431	5 W	80	0.70
symmetric, narrow beam [E] 	145-7240	LED-1/4W / 350 mA - 2700 K	415.2	5 W	80	0.70
	145-7241	LED-1/4W / 350 mA - 3000 K	415.2	5 W	80	0.70
	145-7242	LED-1/4W / 350 mA - 4000 K	449.1	5 W	80	0.70
symmetric, very narrow beam [EE] 	145-7186	LED-1/4W / 350 mA - 2700 K	415.5	5 W	80	0.70
	145-7187	LED-1/4W / 350 mA - 3000 K	415.5	5 W	80	0.70
	145-7188	LED-1/4W / 350 mA - 4000 K	449.5	5 W	80	0.70
symmetric, very narrow beam, sharp cut-off [EES] 	145-7189	LED-1/4W / 350 mA - 2700 K	382.2	5 W	80	0.70
	145-7190	LED-1/4W / 350 mA - 3000 K	382.2	5 W	80	0.70
	145-7191	LED-1/4W / 350 mA - 4000 K	411.6	5 W	80	0.70
symmetric, wide beam [B] 	145-7180	LED-1/4W / 350 mA - 2700 K	379.1	5 W	80	0.70
	145-7181	LED-1/4W / 350 mA - 3000 K	379.1	5 W	80	0.70
	145-7182	LED-1/4W / 350 mA - 4000 K	410.1	5 W	80	0.70
wallwash	145-7183+145-7230	LED-1/4W / 350 mA - 2700 K	358.8	5 W	80	0.70

FLC301 Spigot mounted

Projectors

we-ef

Light distribution	Part ID	Light source	Rated lumens	Rated input power	CRI	Weight (kg)
	145-7184+145-7230	LED-1/4W / 350 mA - 3000 K	331.7	5 W	80	0.70
	145-7185+145-7230	LED-1/4W / 350 mA - 4000 K	358.8	5 W	80	0.70

WE-EF LEUCHTEN GmbH

Töpinger Straße 16, 29646 Bispingen, Germany - Phone: +49 5194 909-0

info@we-ef.com - <https://we-ef.com>

Subject to technical changes and errors. - Generated on 23/10/2024

Mounting Accessories

Flat surface and Column fitter

Description	Part ID	A	B	Weight (kg)
Column fitter FLC300	145-9536	70		0.20

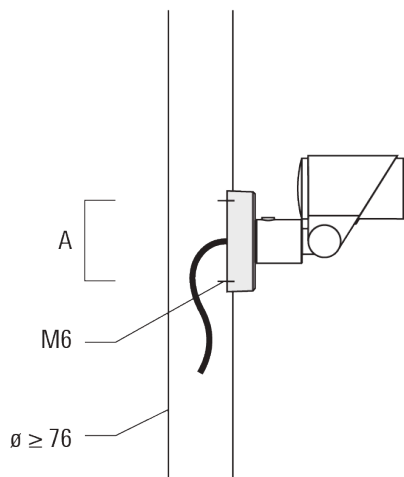

Flat surface fitter FLC300	145-9535	100	85	0.20
----------------------------	----------	-----	----	------

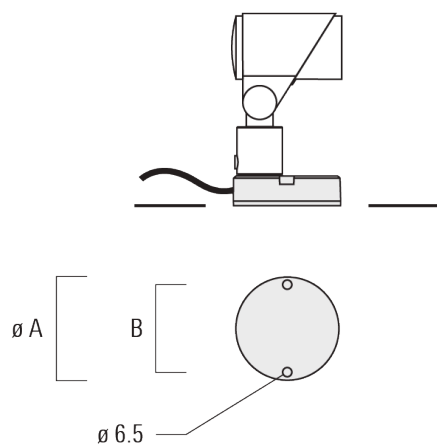

Ground spike EF

WE-EF LEUCHTEN GmbH

Töpinger Straße 16, 29646 Bispingen, Germany - Phone: +49 5194 909-0

info@we-ef.com - <https://we-ef.com>

Subject to technical changes and errors. - Generated on 23/10/2024

Projectors

Description	Part ID	A	Weight (kg)
Ground spike EF1 for FLC300	310-9102	270	1.20

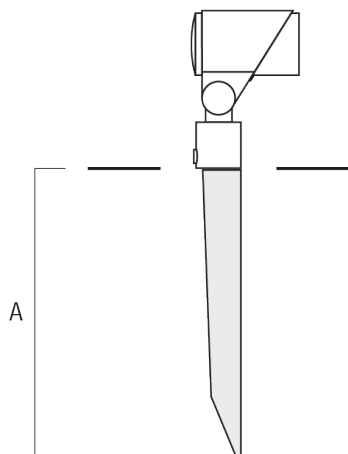

Junction box JB1

Description	Part ID	A	B	C1	D1	Weight (kg)
Junction box JB1 with side entry	310-9002	107	67	135	67	1.20

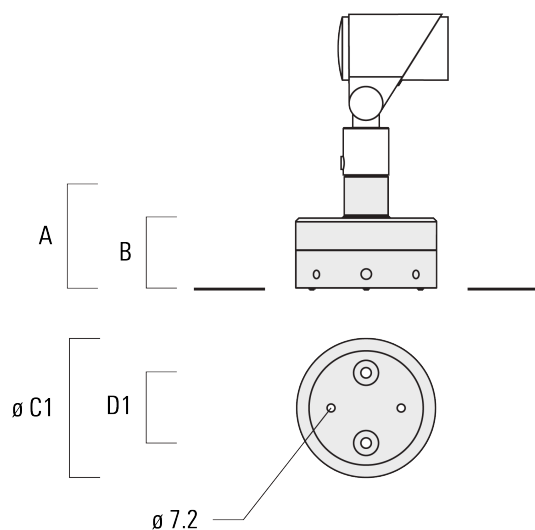

Description	Part ID	A	B	C1	D1	Weight (kg)
Junction box JB1 with wall entry	310-9025	107	67	135	67	1.10

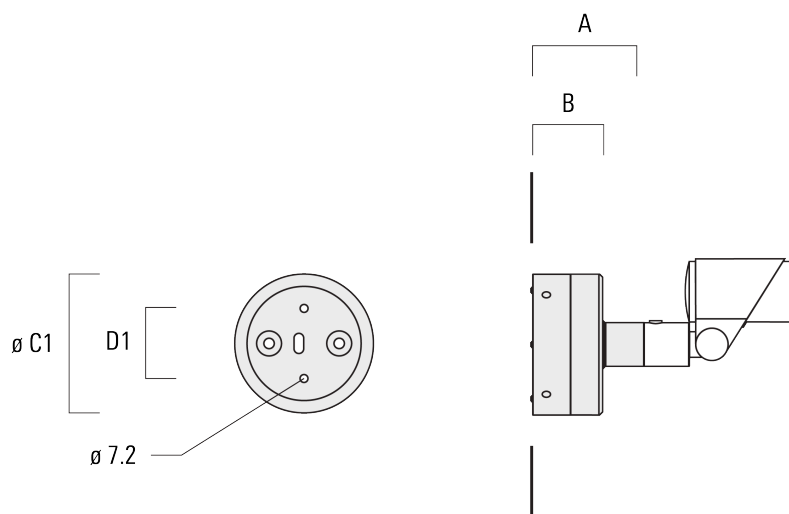

Optical Accessories

Linear spread lens

Description	Part ID	C1
Linear spread lens IO-180	145-7229	42.5

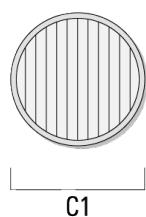

Wallwash lens

Description	Part ID	C1
IO-20-WW-FLC301-LED	145-7230	42.5

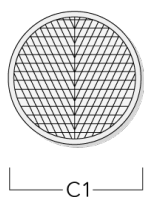

Honeycomb louvre

WE-EF LEUCHTEN GmbH

Töpinger Straße 16, 29646 Bispingen, Germany - Phone: +49 5194 909-0

info@we-ef.com - <https://we-ef.com>

Subject to technical changes and errors. - Generated on 23/10/2024

Projectors

Description	Part ID	C1
Honeycomb louvre IW	145-7231	42.5

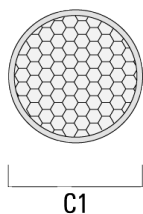

Glare shield

Description	Part ID	A	C1
Glare shield ES	145-7232	20.5	58

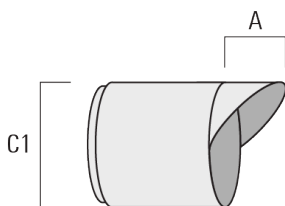

Snoot

WE-EF LEUCHTEN GmbH

Töpinger Straße 16, 29646 Bispingen, Germany - Phone: +49 5194 909-0

info@we-ef.com - <https://we-ef.com>

Subject to technical changes and errors. - Generated on 23/10/2024

FLC301 Spigot mounted

Projectors

Description	Part ID	A	C1
Snoot ET	145-7233	22.5	58

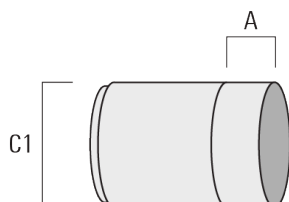

**FLC301 Spigot mounted
Projectors**

WE-EF LEUCHTEN GmbH

Töpinger Straße 16, 29646 Bispingen, Germany
Phone: +49 5194 909-0

info@we-ef.com
<https://we-ef.com>

Subject to technical changes and errors.
Generated on 23/10/2024