

### **Description**

IP66. IK08. Marine-grade, die-cast aluminium alloy. 5CE superior corrosion protection including PCS hardware. Safety glass lens. Silicone CCG® Controlled Compression Gasket. Luminaire is factory-sealed and does not need to be opened during installation. Knuckle permits 340° rotation, forward tilt 73° and backward tilt 90°.

Integral EC electronic converter. Advanced thermal management protects LEDs while optimising lumens output. CAD-optimised optics for superior illumination and glare control. Including 1.5 m of flexible PVC free cable.





Mains voltage versions, ON-OFF Class I. 1-10 V analogue dimming or DALI interface available on request; refer to accessory listings.

Optical accessories are factory-installed. To be specified at time of ordering.

### Specifications

#### Material description

---

Body	Marine-grade, die-cast aluminium alloy
Lens	Safety glass lens
Colours	 RAL9004 Signal black  RAL9006 White aluminium  RAL9007 Grey aluminium  RAL7016 Anthracite grey  RAL9016 Traffic white
Gasket	Silicone CCG® Controlled Compression Gasket
Fasteners	PCS hardware
Ingress protection	IP66
Impact resistance	IK08
Corrosion resistance	5CE
Windage	0.020 m <sup>2</sup>

---

#### Electrical description

---

Driver / Ballast	Integral EC electronic converter
Power factor	>0.9

---

#### Additional information

---

Lifetime	Ta=25° L90B10 > 90000h
Energy efficiency class	D-E (Light source)

---

# FLC311 Spigot mounted

## Projectors

**we-ef**

### Options

#### Light distribution



symmetric, wide beam [B]



symmetric, medium beam [M]



symmetric, very narrow beam [EE]



symmetric, very narrow beam, sharp cut-off [EES]



wallwash



linear spread, very narrow beam [EE]



linear spread, very narrow beam, sharp cut-off [EES]

#### Colour temperature



2700 K



3000 K



4000 K

#### Nominal Watt



0 W



#### WE-EF LEUCHTEN GmbH

Töpinger Straße 16, 29646 Bispingen, Germany - Phone: +49 5194 909-0  
info@we-ef.com - <https://we-ef.com>

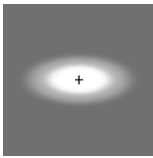
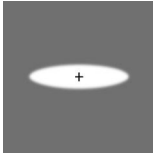
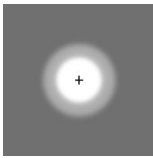
Subject to technical changes and errors. - Generated on 04/05/2025

### Configurations

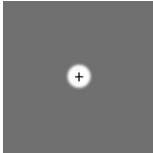
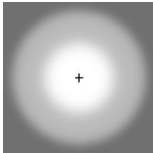
Light distribution	Part ID	Light source	Rated lumens	Rated input power	CRI	Weight (kg)
linear spread, very narrow beam [EE] 	145-7618+145-7781	LED-3/6W / 180 mA - 2700 K	539.2	7.5 W	80	1.60
	145-7619+145-7781	LED-3/9W / 250 mA - 2700 K	756.9	11 W	80	1.60
	145-7620+145-7781	LED-3/12W / 350 mA - 2700 K	1016.1	13.9 W	80	1.60
	145-7621+145-7781	LED-3/6W / 180 mA - 3000 K	539.2	7.5 W	80	1.60
	145-7622+145-7781	LED-3/9W / 250 mA - 3000 K	756.9	11 W	80	1.60
	145-7623+145-7781	LED-3/12W / 350 mA - 3000 K	1016.1	13.9 W	80	1.60
	145-7624+145-7781	LED-3/6W / 180 mA - 4000 K	580.6	7.5 W	80	1.60
	145-7625+145-7781	LED-3/9W / 250 mA - 4000 K	808.7	11 W	80	1.60
	145-7626+145-7781	LED-3/12W / 350 mA - 4000 K	1099.1	13.9 W	80	1.60
linear spread, very narrow beam, sharp cut-off [EES] 	145-7627+145-7781	LED-3/6W / 180 mA - 2700 K	528.4	7.5 W	80	1.60
	145-7628+145-7781	LED-3/9W / 250 mA - 2700 K	748.5	11 W	80	1.60
	145-7629+145-7781	LED-3/12W / 350 mA - 2700 K	1001.7	13.9 W	80	1.60
	145-7630+145-7781	LED-3/6W / 180 mA - 3000 K	528.4	7.5 W	80	1.60
	145-7631+145-7781	LED-3/9W / 250 mA - 3000 K	748.5	11 W	80	1.60
	145-7632+145-7781	LED-3/12W / 350 mA - 3000 K	1001.7	13.9 W	80	1.60
	145-7633+145-7781	LED-3/6W / 180 mA - 4000 K	572.4	7.5 W	80	1.60
	145-7634+145-7781	LED-3/9W / 250 mA - 4000 K	803.6	11 W	80	1.60
	145-7635+145-7781	LED-3/12W / 350 mA - 4000 K	1078.8	13.9 W	80	1.60
symmetric, medium beam [M] 	145-7609	LED-3/6W / 180 mA - 2700 K	600.4	7.5 W	80	1.60
	145-7610	LED-3/9W / 250 mA - 2700 K	842.9	11 W	80	1.60
	145-7611	LED-3/12W / 350 mA - 2700 K	1131.6	13.9 W	80	1.60
	145-7612	LED-3/6W / 180 mA - 3000 K	600.4	7.5 W	80	1.60
	145-7613	LED-3/9W / 250 mA - 3000 K	842.9	11 W	80	1.60
	145-7614	LED-3/12W / 350 mA - 3000 K	1131.6	13.9 W	80	1.60
	145-7615	LED-3/6W / 180 mA - 4000 K	646.6	7.5 W	80	1.60
	145-7616	LED-3/9W / 250 mA - 4000 K	900.6	11 W	80	1.60
	145-7617	LED-3/12W / 350 mA - 4000 K	1224	13.9 W	80	1.60
symmetric, very narrow beam [EE] 	145-7618	LED-3/6W / 180 mA - 2700 K	605.2	7.5 W	80	1.60
	145-7619	LED-3/9W / 250 mA - 2700 K	849.6	11 W	80	1.60
	145-7620	LED-3/12W / 350 mA - 2700 K	1140.5	13.9 W	80	1.60
	145-7621	LED-3/6W / 180 mA - 3000 K	605.2	7.5 W	80	1.60
	145-7622	LED-3/9W / 250 mA - 3000 K	849.6	11 W	80	1.60
	145-7623	LED-3/12W / 350 mA - 3000 K	1140.5	13.9 W	80	1.60
	145-7624	LED-3/6W / 180 mA - 4000 K	651.7	7.5 W	80	1.60
	145-7625	LED-3/9W / 250 mA - 4000 K	907.8	11 W	80	1.60

Light distribution	Part ID	Light source	Rated lumens	Rated input power	CRI	Weight (kg)
symmetric, very narrow beam, sharp cut-off [EES] 	145-7626	LED-3/12W / 350 mA - 4000 K	1233.6	13.9 W	80	1.60
	145-7627	LED-3/6W / 180 mA - 2700 K	606.3	7.5 W	80	1.60
	145-7628	LED-3/9W / 250 mA - 2700 K	858.9	11 W	80	1.60
	145-7629	LED-3/12W / 350 mA - 2700 K	1149.4	13.9 W	80	1.60
	145-7630	LED-3/6W / 180 mA - 3000 K	606.3	7.5 W	80	1.60
	145-7631	LED-3/9W / 250 mA - 3000 K	858.9	11 W	80	1.60
	145-7632	LED-3/12W / 350 mA - 3000 K	1149.4	13.9 W	80	1.60
	145-7633	LED-3/6W / 180 mA - 4000 K	656.8	7.5 W	80	1.60
	145-7634	LED-3/9W / 250 mA - 4000 K	922	11 W	80	1.60
	145-7635	LED-3/12W / 350 mA - 4000 K	1237.8	13.9 W	80	1.60
symmetric, wide beam [B] 	145-7600	LED-3/6W / 180 mA - 2700 K	595.4	7.5 W	80	1.60
	145-7601	LED-3/9W / 250 mA - 2700 K	835.8	11 W	80	1.60
	145-7602	LED-3/12W / 350 mA - 2700 K	1122.1	13.9 W	80	1.60
	145-7603	LED-3/6W / 180 mA - 3000 K	595.4	7.5 W	80	1.60
	145-7604	LED-3/9W / 250 mA - 3000 K	835.8	11 W	80	1.60
	145-7605	LED-3/12W / 350 mA - 3000 K	1122.1	13.9 W	80	1.60
	145-7606	LED-3/6W / 180 mA - 4000 K	641.2	7.5 W	80	1.60
	145-7607	LED-3/9W / 250 mA - 4000 K	893.1	11 W	80	1.60
	145-7608	LED-3/12W / 350 mA - 4000 K	1213.7	13.9 W	80	1.60
wallwash 	145-7609+145-7782	LED-3/6W / 180 mA - 2700 K	408.7	7.5 W	80	1.60
	145-7610+145-7782	LED-3/9W / 250 mA - 2700 K	573.7	11 W	80	1.60
	145-7611+145-7782	LED-3/12W / 350 mA - 2700 K	770.2	13.9 W	80	1.60
	145-7612+145-7782	LED-3/6W / 180 mA - 3000 K	408.7	7.5 W	80	1.60
	145-7613+145-7782	LED-3/9W / 250 mA - 3000 K	573.7	11 W	80	1.60
	145-7614+145-7782	LED-3/12W / 350 mA - 3000 K	770.2	13.9 W	80	1.60
	145-7615+145-7782	LED-3/6W / 180 mA - 4000 K	440.1	7.5 W	80	1.60
	145-7616+145-7782	LED-3/9W / 250 mA - 4000 K	613	11 W	80	1.60
	145-7617+145-7782	LED-3/12W / 350 mA - 4000 K	833.1	13.9 W	80	1.60

### Mounting Accessories

#### Flat surface and Column fitter

Description	Part ID	A	B	Weight (kg)
Column fitter FLC300	145-9536	70		0.20

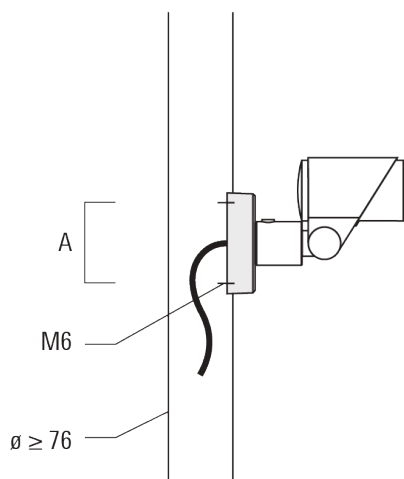

Flat surface fitter FLC300	145-9535	100	85	0.20
----------------------------	----------	-----	----	------

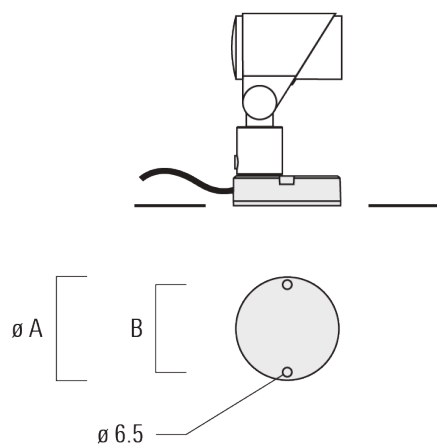

### Ground spike EF

Description	Part ID	A	Weight (kg)
Ground spike EF1 for FLC300	310-9102	270	1.20

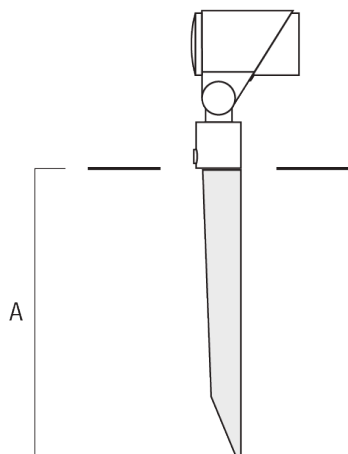

### Junction box JB1

Description	Part ID	A	B	C1	D1	Weight (kg)
Junction box JB1 with side entry	310-9002	107	67	135	67	1.20

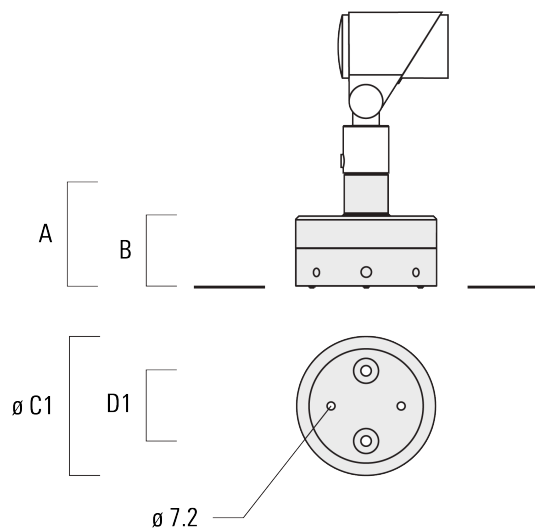

## Projectors

Description	Part ID	A	B	C1	D1	Weight (kg)
Junction box JB1 with wall entry	310-9025	107	67	135	67	1.10

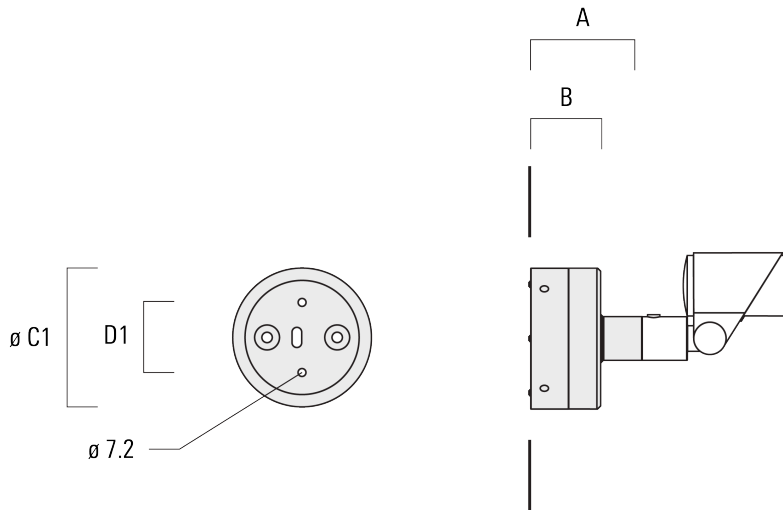



**Optical Accessories**

**Flood lens**

---

Description	Part ID	C1
IO-360-FLC311 for [EE]	145-7786	59

---

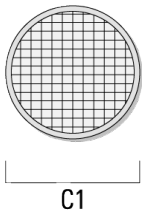

---

IO-360-FLC311 for [EES]	145-7780	59
-------------------------	----------	----

---

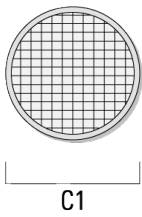

## Projectors

### Linear spread lens

---

Description	Part ID	C1
IO-180-FLC311	145-7781	59

---

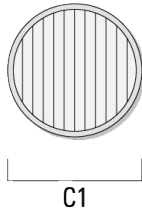

---

### Wallwash lens

---

Description	Part ID	C1
IO-20-FLC311	145-7782	59

---

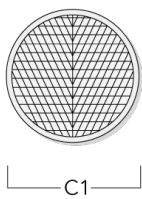

## Projectors

### Honeycomb louvre

---

Description	Part ID	C1
IW-FLC311	145-7783	59

---

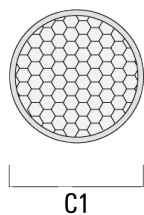

---

### Glare shield

---

Description	Part ID	A	C1
ES-FLC311	145-7784	34	85

---

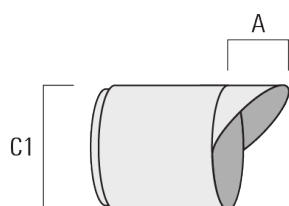

## Projectors

### Snoot

---

Description	Part ID	A	C1
ET-FLC311	145-7785	34	85

---

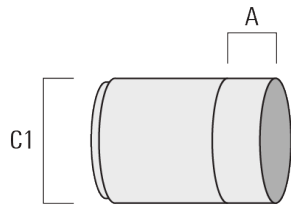

**Control**

**0-10 V, 24VDC low voltage version**

Description	Part ID
24VDC low voltage version, 0-10 V	0033