

Description

IP66. IK08. Marine-grade, die-cast aluminium alloy. 5CE superior corrosion protection including PCS hardware. Safety glass lens. Silicone CCG® Controlled Compression Gasket. Luminaire is factory-sealed and does not need to be opened during installation.



Integral EC electronic converter. Advanced thermal management protects LEDs while optimising lumens output. CAD-optimised optics for superior illumination and glare control. Including 1.5 m of flexible PVC free cable.

Mains voltage versions: DALI interface Class I.

Optical accessories are factory-installed. To be specified at time of ordering.

Specifications

Material description

Body	Marine-grade, die-cast aluminium alloy
Lens	Safety glass lens
Colours	 RAL9004 Signal black  RAL9006 White aluminium  RAL9007 Grey aluminium
Gasket	Silicone CCG® Controlled Compression Gasket
Fasteners	PCS hardware
Ingress protection	IP66
Impact resistance	IK08
Corrosion resistance	5CE
Windage	0.040 m ²

Electrical description

Driver / Ballast	DALI
Power factor	>0.9

Additional information

Lifetime	Ta=40° L90B10 > 90000h
----------	------------------------

FLC321 Spigot mounted

Projectors

we-ef

Options

Light distribution



symmetric, wide beam [B]



symmetric, medium beam [M]



symmetric, very narrow beam [EE]



symmetric, very narrow beam, sharp cut-off [EES]



linear spread, very narrow beam [EE]



linear spread, very narrow beam, sharp cut-off [EES]



wallwash

Colour temperature



2700 K



3000 K







4000 K

Nominal Watt

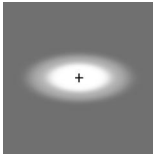
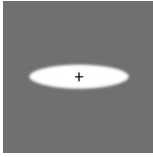
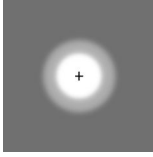
0 W

Configurations

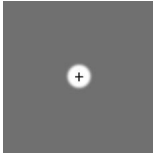
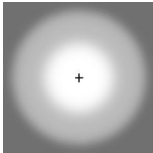
Light distribution	Part ID	Light source	Rated lumens	Rated input power	CRI	Weight (kg)
linear spread, very narrow beam [EE] 	145-7326+145-9991	LED-6/26W / 1400 mA - 2700K	2027.2	29 W	80	2.60
	145-7327+145-9991	LED-6/26W / 1400 mA - 3000K	2144.1	29 W	80	2.60
	145-7328+145-9991	LED-6/26W / 1400 mA - 4000K	2241.6	29 W	80	2.60
	145-9955+145-9991	LED-6/12W / 700 mA - 2700 K	1096	14.5 W	80	2.60
	145-9956+145-9991	LED-6/18W / 1050 mA - 2700 K	1522.2	21 W	80	2.60
	145-9957+145-9991	LED-6/12W / 700 mA - 3000 K	1177.2	14.5 W	80	2.60
	145-9958+145-9991	LED-6/18W / 1050 mA - 3000 K	1644	21 W	80	2.60
	145-9959+145-9991	LED-6/12W / 700 mA - 4000 K	1258.4	14.5 W	80	2.60
	145-9960+145-9991	LED-6/18W / 1050 mA - 4000 K	1745.5	21 W	80	2.60
linear spread, very narrow beam, sharp cut-off [EES] 	145-7329+145-9991	LED-6/26W / 1400 mA - 2700K	2158.4	29 W	80	2.60
	145-7330+145-9991	LED-6/26W / 1400 mA - 3000K	2282.9	29 W	80	2.60
	145-7331+145-9991	LED-6/26W / 1400 mA - 4000K	2386.7	29 W	80	2.60
	145-9961+145-9991	LED-6/12W / 700 mA - 2700 K	1125.5	14.5 W	80	2.60
	145-9962+145-9991	LED-6/18W / 1050 mA - 2700 K	1563.1	21 W	80	2.60
	145-9963+145-9991	LED-6/12W / 700 mA - 3000 K	1208.8	14.5 W	80	2.60
	145-9964+145-9991	LED-6/18W / 1050 mA - 3000 K	1688.2	21 W	80	2.60
	145-9965+145-9991	LED-6/12W / 700 mA - 4000 K	1292.2	14.5 W	80	2.60
	145-9966+145-9991	LED-6/18W / 1050 mA - 4000 K	1792.4	21 W	80	2.60
symmetric, medium beam [M] 	145-7323	LED-6/26W / 1400 mA - 2700K	2179.3	29 W	80	2.60
	145-7324	LED-6/26W / 1400 mA - 3000K	2305	29 W	80	2.60
	145-7325	LED-6/26W / 1400 mA - 4000K	2409.8	29 W	80	2.60
	145-9949	LED-6/12W / 700 mA - 2700 K	1162.6	14.5 W	80	2.60
	145-9950	LED-6/18W / 1050 mA - 2700 K	1614.8	21 W	80	2.60
	145-9951	LED-6/12W / 700 mA - 3000 K	1248.7	14.5 W	80	2.60
	145-9952	LED-6/18W / 1050 mA - 3000 K	1743.9	21 W	80	2.60
	145-9953	LED-6/12W / 700 mA - 4000 K	1334.9	14.5 W	80	2.60
	145-9954	LED-6/18W / 1050 mA - 4000 K	1851.6	21 W	80	2.60
symmetric, very narrow beam [EE] 	145-7326	LED-6/26W / 1400 mA - 2700K	2258.5	29 W	80	2.60
	145-7327	LED-6/26W / 1400 mA - 3000K	2388.8	29 W	80	2.60
	145-7328	LED-6/26W / 1400 mA - 4000K	2497.4	29 W	80	2.60
	145-9955	LED-6/12W / 700 mA - 2700 K	1224.7	14.5 W	80	2.60
	145-9956	LED-6/18W / 1050 mA - 2700 K	1701	21 W	80	2.60
	145-9957	LED-6/12W / 700 mA - 3000 K	1315.4	14.5 W	80	2.60
	145-9958	LED-6/18W / 1050 mA - 3000 K	1837.1	21 W	80	2.60
	145-9959	LED-6/12W / 700 mA - 4000 K	1406.2	14.5 W	80	2.60

Light distribution	Part ID	Light source	Rated lumens	Rated input power	CRI	Weight (kg)
symmetric, very narrow beam, sharp cut-off [EES] 	145-9960	LED-6/18W / 1050 mA - 4000 K	1950.5	21 W	80	2.60
	145-7329	LED-6/26W / 1400 mA - 2700K	2319.7	29 W	80	2.60
	145-7330	LED-6/26W / 1400 mA - 3000K	2453.5	29 W	80	2.60
	145-7331	LED-6/26W / 1400 mA - 4000K	2565	29 W	80	2.60
	145-9961	LED-6/12W / 700 mA - 2700 K	1259.7	14.5 W	80	2.60
	145-9962	LED-6/18W / 1050 mA - 2700 K	1749.6	21 W	80	2.60
	145-9963	LED-6/12W / 700 mA - 3000 K	1353	14.5 W	80	2.60
	145-9964	LED-6/18W / 1050 mA - 3000 K	1889.5	21 W	80	2.60
	145-9965	LED-6/12W / 700 mA - 4000 K	1446.3	14.5 W	80	2.60
	145-9966	LED-6/18W / 1050 mA - 4000 K	2006.2	21 W	80	2.60
symmetric, wide beam [B] 	145-7320	LED-6/26W / 1400 mA - 2700K	1665.8	29 W	80	2.60
	145-7321	LED-6/26W / 1400 mA - 3000K	1761.9	29 W	80	2.60
	145-7322	LED-6/26W / 1400 mA - 4000K	1842	29 W	80	2.60
	145-9943	LED-6/12W / 700 mA - 2700 K	887.8	14.5 W	80	2.60
	145-9944	LED-6/18W / 1050 mA - 2700 K	1233	21 W	80	2.60
	145-9945	LED-6/12W / 700 mA - 3000 K	953.5	14.5 W	80	2.60
	145-9946	LED-6/18W / 1050 mA - 3000 K	1331.7	21 W	80	2.60
	145-9947	LED-6/12W / 700 mA - 4000 K	1019.3	14.5 W	80	2.60
	145-9948	LED-6/18W / 1050 mA - 4000 K	1413.9	21 W	80	2.60
wallwash 	145-7323+145-9993	LED-6/26W / 1400 mA - 2700K	1807.9	29 W	80	2.60
	145-7324+145-9993	LED-6/26W / 1400 mA - 3000K	1912.2	29 W	80	2.60
	145-7325+145-9993	LED-6/26W / 1400 mA - 4000K	1999.1	29 W	80	2.60
	145-9949+145-9993	LED-6/12W / 700 mA - 2700 K	991.7	14.5 W	80	2.60
	145-9950+145-9993	LED-6/18W / 1050 mA - 2700 K	1377.4	21 W	80	2.60
	145-9951+145-9993	LED-6/12W / 700 mA - 3000 K	1065.2	14.5 W	80	2.60
	145-9952+145-9993	LED-6/18W / 1050 mA - 3000 K	1487.6	21 W	80	2.60
	145-9953+145-9993	LED-6/12W / 700 mA - 4000 K	1138.6	14.5 W	80	2.60
145-9954+145-9993	LED-6/18W / 1050 mA - 4000 K	1579.4	21 W	80	2.60	

FLC321 Spigot mounted

Projectors

we-ef

Control

Eco Step Dim® Advanced

Description	Part ID
Eco Step Dim® Advanced LED	430-0002

0-10 V, 24VDC low voltage version

Description	Part ID
24VDC low voltage version, 0-10 V	0033

WE-EF LIGHTING Pty Ltd

6/13 Downard Street, 3195 Braeside, Victoria - Phone: +61 3 8587 0444 - Fax: +61 3 8587 0499

info.australia@we-ef.com - <https://we-ef.com/aus>

Subject to technical changes and errors. - Generated on 23/11/2024

Mounting Accessories

Flat surface and Column fitter

Description	Part ID	A	B	Weight (kg)
Column fitter FLC300	145-9536	70		0.20

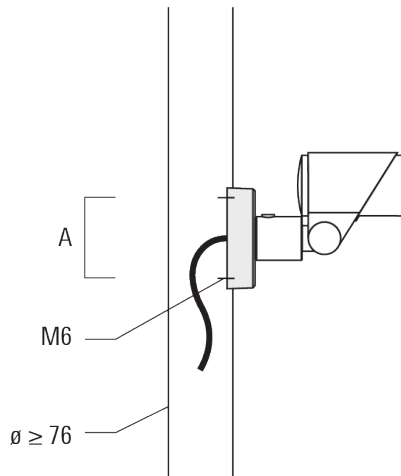

Flat surface fitter FLC300	145-9535	100	85	0.20
----------------------------	----------	-----	----	------

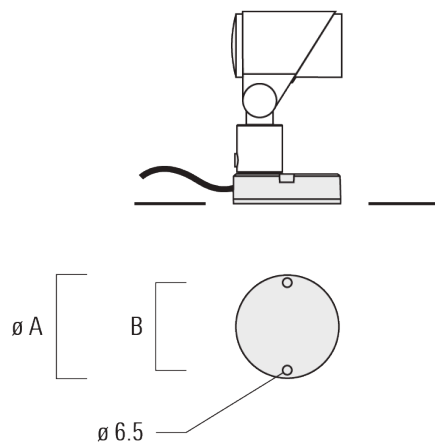

Projectors

Ground spike EF

Description	Part ID	A	Weight (kg)
Ground spike EF1 for FLC300	310-9102	270	1.20

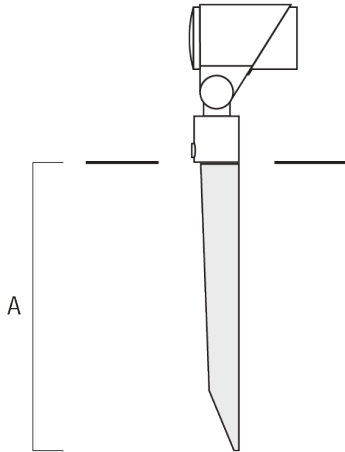

Junction box JB1

Description	Part ID	A	B	C1	D1	Weight (kg)
Junction box JB1 with side entry	310-9002	107	67	135	67	1.20

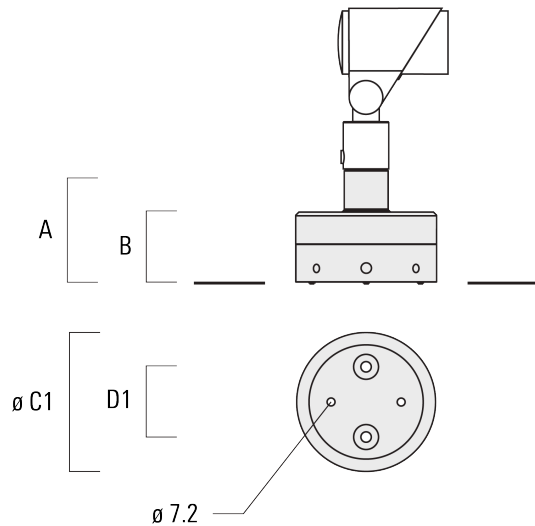

FLC321 Spigot mounted

Projectors

Description	Part ID	A	B	C1	D1	Weight (kg)
Junction box JB1 with wall entry	310-9025	107	67	135	67	1.10

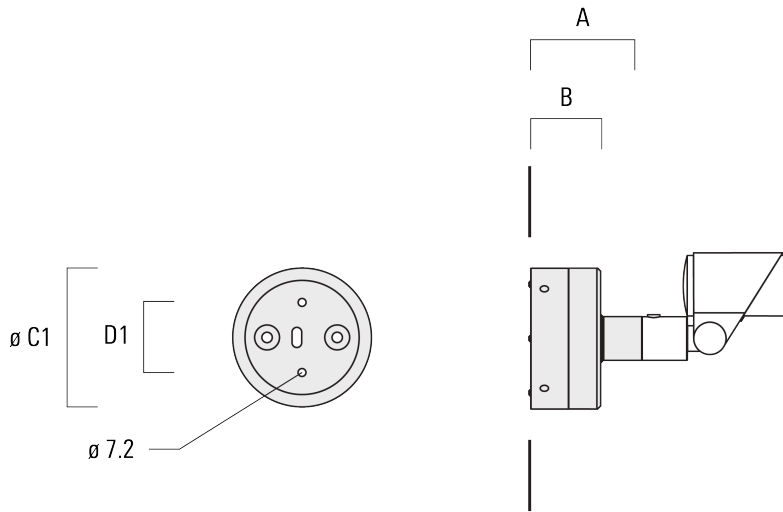

Junction box JB1 with side entry (conduit)	310-9022	107	67	135	67	1.20
---	----------	-----	----	-----	----	------

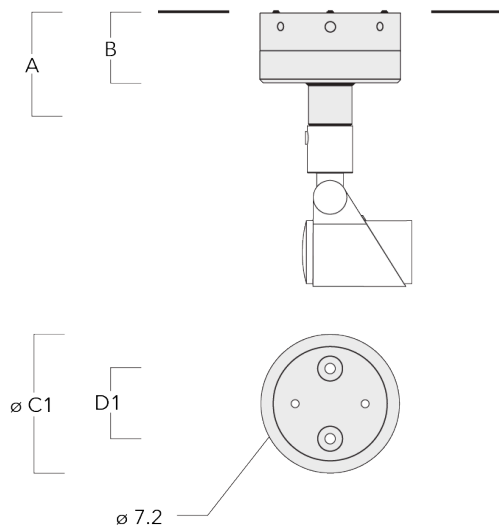

Optical Accessories

Surface wash lens

Description	Part ID	C1
Flood lens IO-360	145-9992	87

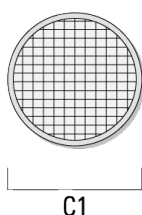

Linear spread lens

Description	Part ID	C1
Linear spread lens IO-180	145-9991	87

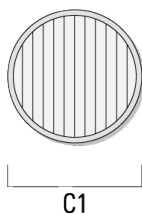

Projectors

Wallwash lens

Description	Part ID	C1
Wallwash lens IO-20	145-9993	87

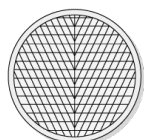

C1

Honeycomb louvre

Description	Part ID	C1
Honeycomb louvre IW	145-9994	87

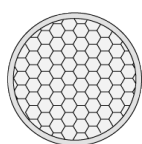

C1

Projectors

Glare shield

Description	Part ID	A	C1
Glare shield ES	145-9995	55	114

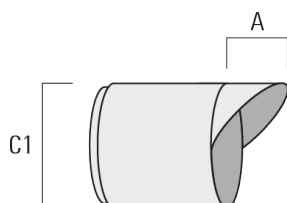

Snoot

Description	Part ID	A	C1
Snoot ET	145-9996	56	114

