

# AFL120 LED

Pole mounted

**we-ef**



Top post

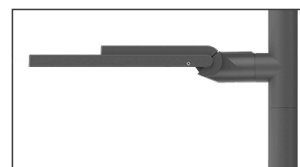

Side entry

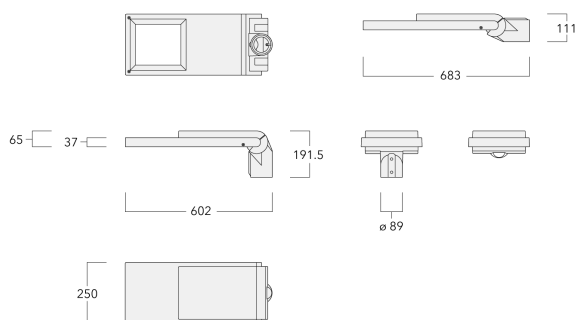

## Description

IP66, Class I. IK08. Marine-grade, die-cast aluminium alloy. 5CE superior corrosion protection including PCS hardware. CCG® Controlled Compression Gasket. Non-reflective flat safety glass cover, hinged. Luminaire is factory-sealed and does not need to be opened during installation.

Integral EC electronic converter. DALI interface. CAD-optimised optics for superior illumination and glare control. OLC® One LED Concept.

Suitable for using as post top or side entry version. Recommend to be specified at time of ordering.

Optional spigot adaptor Ø 60 x 100 mm or 42 x 100 mm available; refer to accessory listings.

**WE-EF LIGHTING (Thailand) Co., Ltd.**





57 Moo 5, Kingkaew Rd., Bangplee, 10540 Samutprakarn - Phone: +66 2 738 96 20 - Fax: +66 2 738 96 29

<https://we-ef.com/asia>

Subject to technical changes and errors. - Generated on 23/11/2024

**Specifications****Material description**

---

Body	Marine-grade, die-cast aluminium alloy
Lens	Non-reflective safety glass lens
Colours	 RAL9004 Signal black  RAL9007 Grey aluminium  RAL7016 Anthracite grey  RAL9016 Traffic white
Gasket	CCG® Controlled Compression Gasket
Fasteners	PCS Polymer Coated Stainless Steel Hardware
Ingress protection	IP66
Impact resistance	IK08
Corrosion resistance	5CE
Windage	0.146 m <sup>2</sup>

---

**Electrical description**

---

Driver / Ballast	Integral electronic converter with DALI interface
Power factor	> 0.9
Surge protection	6/6kV, optional 10kV

---

**Additional information**

---

Lifetime	Ta=25° L90B10 > 90000h
----------	------------------------

---











# AFL120 LED

Pole mounted





**we-ef**

## Options

### Light distribution

	asymmetric, side throw [S61]
	asymmetric, side throw [S66]
	asymmetric, side throw [S65]
	pedestrian crossing, right-hand traffic [P46R]
	rectangular, side throw [R60]
	pedestrian/bicycle lane [P66]
	asymmetric, forward throw [A61]
	square distribution [Q66]
	pedestrian crossing, left-hand traffic [P46L]
	asymmetric, side throw [S71]
	rectangular, side throw [R61]

### Colour temperature

	2200 K
	2700 K
	3000 K
	4000 K

### Nominal Watt

24 W  
36 W  
72 W

**WE-EF LIGHTING (Thailand) Co., Ltd.**

57 Moo 5, Kingkaew Rd., Bangplee, 10540 Samutprakarn - Phone: +66 2 738 96 20 - Fax: +66 2 738 96 29

<https://we-ef.com/asia>

Subject to technical changes and errors. - Generated on 23/11/2024

## Configurations

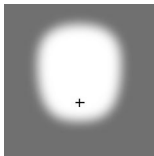
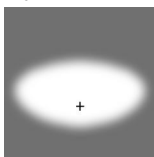
Light distribution	Part ID	Light source	Rated lumens	Rated input power	CRI	Weight (kg)
asymmetric, forward throw [A61] 	102-0026	LED-24/24W / 350 mA - 2200 K	3136.5	26.5 W	70	7.00
	102-0027	LED-24/24W / 350 mA - 2700 K	3136.5	26.5 W	80	7.00
	102-0027-70	LED-24/24W / 350 mA - 2700 K	3352.9	26.5 W	70	7.00
	102-0028	LED-24/24W / 350 mA - 3000 K	3352.9	26.5 W	80	7.00
	102-0028-70	LED-24/24W / 350 mA - 3000 K	3893.6	26.5 W	70	7.00
	102-0029	LED-24/24W / 350 mA - 4000 K	3677.3	26.5 W	80	7.00
	102-0029-70	LED-24/24W / 350 mA - 4000 K	4110	26.5 W	70	7.00
	102-0071	LED-24/36W / 500 mA - 2200K	4120.3	39 W	70	7.00
	102-0072	LED-24/36W / 500 mA - 2700K	4120.3	39 W	80	7.00
	102-0072-70	LED-24/36W / 500 mA - 2700K	4429.4	39 W	70	7.00
	102-0073	LED-24/36W / 500 mA - 3000 K	4429.4	39 W	80	7.00
	102-0073-70	LED-24/36W / 500 mA - 3000 K	5047.4	39 W	70	7.00
	102-0074	LED-24/36W / 500 mA - 4000 K	4738.4	39 W	80	7.00
	102-0074-70	LED-24/36W / 500 mA - 4000 K	5356.4	39 W	70	7.00
	102-0116	LED-24/48W / 700 mA - 2200 K	5562.5	54 W	70	7.00
	102-0117	LED-24/48W / 700 mA - 2700 K	5562.5	54 W	80	7.00
	102-0117-70	LED-24/48W / 700 mA - 2700 K	5974.5	54 W	70	7.00
	102-0118	LED-24/48W / 700 mA - 3000 K	5974.5	54 W	80	7.00
	102-0118-70	LED-24/48W / 700 mA - 3000 K	6798.6	54 W	70	7.00
	102-0119	LED-24/48W / 700 mA - 4000 K	6386.5	54 W	80	7.00
	102-0119-70	LED-24/48W / 700 mA - 4000 K	7210.6	54 W	70	7.00
	102-0880	LED-24/72W / 1050 mA - 2200 K	7416.7	81 W	70	7.00
	102-0881	LED-24/72W / 1050 mA - 2700 K	7416.7	81 W	80	7.00
	102-0881-70	LED-24/72W / 1050 mA - 2700 K	8010	81 W	70	7.00
	102-0882	LED-24/72W / 1050 mA - 3000 K	8010	81 W	80	7.00
	102-0882-70	LED-24/72W / 1050 mA - 3000 K	9097.8	81 W	70	7.00
102-0883	LED-24/72W / 1050 mA - 4000 K	8504.4	81 W	80	7.00	
102-0883-70	LED-24/72W / 1050 mA - 4000 K	9691.1	81 W	70	7.00	
asymmetric, side throw [S61] 	102-0001	LED-24/24W / 350 mA - 2200 K	3309.7	26.5 W	70	7.00
	102-0002	LED-24/24W / 350 mA - 2700 K	3309.7	26.5 W	80	7.00
	102-0002-70	LED-24/24W / 350 mA - 2700 K	3537.9	26.5 W	70	7.00
	102-0003	LED-24/24W / 350 mA - 3000 K	3537.9	26.5 W	80	7.00
	102-0003-70	LED-24/24W / 350 mA - 3000 K	4108.6	26.5 W	70	7.00
	102-0004	LED-24/24W / 350 mA - 4000 K	3880.3	26.5 W	80	7.00
	102-0004-70	LED-24/24W / 350 mA - 4000 K	4336.8	26.5 W	70	7.00

# AFL120 LED

## Pole mounted

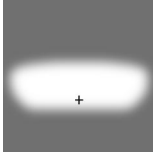
Light distribution	Part ID	Light source	Rated lumens	Rated input power	CRI	Weight (kg)
	102-0046	LED-24/36W / 500 mA - 2200K	4347.8	39 W	70	7.00
	102-0047	LED-24/36W / 500 mA - 2700K	4347.8	39 W	80	7.00
	102-0047-70	LED-24/36W / 500 mA - 2700K	4673.9	39 W	70	7.00
	102-0048	LED-24/36W / 500 mA - 3000 K	4673.9	39 W	80	7.00
	102-0048-70	LED-24/36W / 500 mA - 3000 K	5326.1	39 W	70	7.00
	102-0049	LED-24/36W / 500 mA - 4000 K	5000	39 W	80	7.00
	102-0049-70	LED-24/36W / 500 mA - 4000 K	5652.2	39 W	70	7.00
	102-0091	LED-24/48W / 700 mA - 2200 K	5869.6	54 W	70	7.00
	102-0092	LED-24/48W / 700 mA - 2700 K	5869.6	54 W	80	7.00
	102-0092-70	LED-24/48W / 700 mA - 2700 K	6304.4	54 W	70	7.00
	102-0093	LED-24/48W / 700 mA - 3000 K	6304.4	54 W	80	7.00
	102-0093-70	LED-24/48W / 700 mA - 3000 K	7173.9	54 W	70	7.00
	102-0094	LED-24/48W / 700 mA - 4000 K	6739.1	54 W	80	7.00
	102-0094-70	LED-24/48W / 700 mA - 4000 K	7608.7	54 W	70	7.00
	102-0860	LED-24/72W / 1050 mA - 2200 K	7826.2	81 W	70	7.00
	102-0861	LED-24/72W / 1050 mA - 2700 K	7826.2	81 W	80	7.00
	102-0861-70	LED-24/72W / 1050 mA - 2700 K	8452.3	81 W	70	7.00
	102-0862	LED-24/72W / 1050 mA - 3000 K	8452.3	81 W	80	7.00
	102-0862-70	LED-24/72W / 1050 mA - 3000 K	9600.2	81 W	70	7.00
	102-0863	LED-24/72W / 1050 mA - 4000 K	8974.1	81 W	80	7.00
	102-0863-70	LED-24/72W / 1050 mA - 4000 K	10226.3	81 W	70	7.00
asymmetric, side throw [S65]	102-0006	LED-24/24W / 350 mA - 2200 K	3301.3	26.5 W	70	7.00
	102-0007	LED-24/24W / 350 mA - 2700 K	3301.3	26.5 W	80	7.00
	102-0007-70	LED-24/24W / 350 mA - 2700 K	3529	26.5 W	70	7.00
	102-0008	LED-24/24W / 350 mA - 3000 K	3529	26.5 W	80	7.00
	102-0008-70	LED-24/24W / 350 mA - 3000 K	4098.2	26.5 W	70	7.00
	102-0009	LED-24/24W / 350 mA - 4000 K	3870.5	26.5 W	80	7.00
	102-0009-70	LED-24/24W / 350 mA - 4000 K	4325.9	26.5 W	70	7.00
	102-0051	LED-24/36W / 500 mA - 2200K	4336.8	39 W	70	7.00
	102-0052	LED-24/36W / 500 mA - 2700K	4336.8	39 W	80	7.00
	102-0052-70	LED-24/36W / 500 mA - 2700K	4662.1	39 W	70	7.00
	102-0053	LED-24/36W / 500 mA - 3000 K	4662.1	39 W	80	7.00
	102-0053-70	LED-24/36W / 500 mA - 3000 K	5312.6	39 W	70	7.00
	102-0054	LED-24/36W / 500 mA - 4000 K	4987.4	39 W	80	7.00
	102-0054-70	LED-24/36W / 500 mA - 4000 K	5637.9	39 W	70	7.00
	102-0096	LED-24/48W / 700 mA - 2200 K	5854.7	54 W	70	7.00

**WE-EF LIGHTING (Thailand) Co., Ltd.**

57 Moo 5, Kingkaew Rd., Bangplee, 10540 Samutprakarn - Phone: +66 2 738 96 20 - Fax: +66 2 738 96 29

<https://we-ef.com/asia>

Subject to technical changes and errors. - Generated on 23/11/2024

# AFL120 LED

## Pole mounted

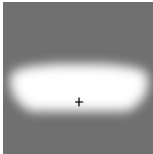
Light distribution	Part ID	Light source	Rated lumens	Rated input power	CRI	Weight (kg)
	102-0097	LED-24/48W / 700 mA - 2700 K	5854.7	54 W	80	7.00
	102-0097-70	LED-24/48W / 700 mA - 2700 K	6288.4	54 W	70	7.00
	102-0098	LED-24/48W / 700 mA - 3000 K	6288.4	54 W	80	7.00
	102-0098-70	LED-24/48W / 700 mA - 3000 K	7155.8	54 W	70	7.00
	102-0099	LED-24/48W / 700 mA - 4000 K	6722.1	54 W	80	7.00
	102-0099-70	LED-24/48W / 700 mA - 4000 K	7589.5	54 W	70	7.00
	102-0864	LED-24/72W / 1050 mA - 2200 K	7806.5	81 W	70	7.00
	102-0865	LED-24/72W / 1050 mA - 2700 K	7806.5	81 W	80	7.00
	102-0865-70	LED-24/72W / 1050 mA - 2700 K	8431	81 W	70	7.00
	102-0866	LED-24/72W / 1050 mA - 3000 K	5032.1	39 W	80	7.00
	102-0866-70	LED-24/72W / 1050 mA - 3000 K	8431	81 W	70	7.00
	102-0867	LED-24/72W / 1050 mA - 4000 K	8951.4	81 W	80	7.00
	102-0867-70	LED-24/72W / 1050 mA - 4000 K	10200.5	81 W	70	7.00
asymmetric, side throw [S66]	102-0308	LED-24/24W / 350 mA - 2200 K	3279.6	26.5 W	70	7.00
	102-0309	LED-24/24W / 350 mA - 2700 K	3279.6	26.5 W	80	7.00
	102-0309-70	LED-24/24W / 350 mA - 2700 K	3505.7	26.5 W	70	7.00
	102-0310	LED-24/24W / 350 mA - 3000 K	3505.7	26.5 W	80	7.00
	102-0310-70	LED-24/24W / 350 mA - 3000 K	4071.2	26.5 W	70	7.00
	102-0311	LED-24/24W / 350 mA - 4000 K	3845	26.5 W	80	7.00
	102-0311-70	LED-24/24W / 350 mA - 4000 K	4297.3	26.5 W	70	7.00
	102-0320	LED-24/36W / 500 mA - 2200K	4308.2	39 W	70	7.00
	102-0321	LED-24/36W / 500 mA - 2700K	4308.2	39 W	80	7.00
	102-0321-70	LED-24/36W / 500 mA - 2700K	4631.3	39 W	70	7.00
	102-0322	LED-24/36W / 500 mA - 3000 K	4631.3	39 W	80	7.00
	102-0322-70	LED-24/36W / 500 mA - 3000 K	5277.6	39 W	70	7.00
	102-0323	LED-24/36W / 500 mA - 4000 K	4954.5	39 W	80	7.00
	102-0323-70	LED-24/36W / 500 mA - 4000 K	5600.7	39 W	70	7.00
	102-0332	LED-24/48W / 700 mA - 2200 K	5816.1	54 W	70	7.00
	102-0333	LED-24/48W / 700 mA - 2700 K	5816.1	54 W	80	7.00
	102-0333-70	LED-24/48W / 700 mA - 2700 K	6246.9	54 W	70	7.00
	102-0334	LED-24/48W / 700 mA - 3000 K	6246.9	54 W	80	7.00
	102-0334-70	LED-24/48W / 700 mA - 3000 K	7108.6	54 W	70	7.00
	102-0335	LED-24/48W / 700 mA - 4000 K	6677.7	54 W	80	7.00
	102-0335-70	LED-24/48W / 700 mA - 4000 K	7539.4	54 W	70	7.00
	102-0896	LED-24/72W / 1050 mA - 2200 K	7755	81 W	70	7.00
	102-0897	LED-24/72W / 1050 mA - 2700 K	7755	81 W	80	7.00

**WE-EF LIGHTING (Thailand) Co., Ltd.**

57 Moo 5, Kingkaew Rd., Bangplee, 10540 Samutprakarn - Phone: +66 2 738 96 20 - Fax: +66 2 738 96 29

<https://we-ef.com/asia>

Subject to technical changes and errors. - Generated on 23/11/2024

# AFL120 LED

## Pole mounted

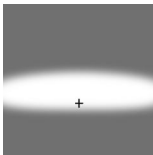
Light distribution	Part ID	Light source	Rated lumens	Rated input power	CRI	Weight (kg)
	102-0897-70	LED-24/72W / 1050 mA - 2700 K	8375.4	81 W	70	7.00
	102-0898	LED-24/72W / 1050 mA - 3000 K	8375.4	81 W	80	7.00
	102-0898-70	LED-24/72W / 1050 mA - 3000 K	9512.8	81 W	70	7.00
	102-0899	LED-24/72W / 1050 mA - 4000 K	8892.4	81 W	80	7.00
	102-0899-70	LED-24/72W / 1050 mA - 4000 K	10133.1	81 W	70	7.00
asymmetric, side throw [S71]	102-0312	LED-24/24W / 350 mA - 2200 K	2971.1	26.5 W	70	7.00
	102-0313	LED-24/24W / 350 mA - 2700 K	2971.1	26.5 W	80	7.00
	102-0313-70	LED-24/24W / 350 mA - 2700 K	3176	26.5 W	70	7.00
	102-0314	LED-24/24W / 350 mA - 3000 K	3176	26.5 W	80	7.00
	102-0314-70	LED-24/24W / 350 mA - 3000 K	3688.3	26.5 W	70	7.00
	102-0315	LED-24/24W / 350 mA - 4000 K	3483.4	26.5 W	80	7.00
	102-0315-70	LED-24/24W / 350 mA - 4000 K	3893.2	26.5 W	70	7.00
	102-0324	LED-24/36W / 500 mA - 2200K	3903.1	39 W	70	7.00
	102-0325	LED-24/36W / 500 mA - 2700K	3903.1	39 W	80	7.00
	102-0325-70	LED-24/36W / 500 mA - 2700K	4195.8	39 W	70	7.00
	102-0326	LED-24/36W / 500 mA - 3000 K	4195.8	39 W	80	7.00
	102-0326-70	LED-24/36W / 500 mA - 3000 K	4781.3	39 W	70	7.00
	102-0327	LED-24/36W / 500 mA - 4000 K	4488.5	39 W	80	7.00
	102-0327-70	LED-24/36W / 500 mA - 4000 K	5074	39 W	70	7.00
	102-0336	LED-24/48W / 700 mA - 2200 K	5269.1	54 W	70	7.00
	102-0337	LED-24/48W / 700 mA - 2700 K	5269.1	54 W	80	7.00
	102-0337-70	LED-24/48W / 700 mA - 2700 K	5659.4	54 W	70	7.00
	102-0338	LED-24/48W / 700 mA - 3000 K	5659.4	54 W	80	7.00
	102-0338-70	LED-24/48W / 700 mA - 3000 K	6440.1	54 W	70	7.00
	102-0339	LED-24/48W / 700 mA - 4000 K	6049.8	54 W	80	7.00
	102-0339-70	LED-24/48W / 700 mA - 4000 K	6830.4	54 W	70	7.00
	102-0900	LED-24/72W / 1050 mA - 2200 K	7025.7	81 W	70	7.00
	102-0901	LED-24/72W / 1050 mA - 2700 K	7025.7	81 W	80	7.00
	102-0901-70	LED-24/72W / 1050 mA - 2700 K	7587.7	81 W	70	7.00
	102-0902	LED-24/72W / 1050 mA - 3000 K	7587.7	81 W	80	7.00
	102-0902-70	LED-24/72W / 1050 mA - 3000 K	8618.1	81 W	70	7.00
	102-0903	LED-24/72W / 1050 mA - 4000 K	8056.1	81 W	80	7.00
	102-0903-70	LED-24/72W / 1050 mA - 4000 K	8056.1	81 W	70	7.00
pedestrian crossing, left-hand traffic [P46L]	102-0041	LED-24/24W / 350 mA - 2200 K	3428.3	26.5 W	70	7.00
	102-0042	LED-24/24W / 350 mA - 2700 K	3428.3	26.5 W	80	7.00
	102-0042-70	LED-24/24W / 350 mA - 2700 K	3664.7	26.5 W	70	7.00

**WE-EF LIGHTING (Thailand) Co., Ltd.**

57 Moo 5, Kingkaew Rd., Bangplee, 10540 Samutprakarn - Phone: +66 2 738 96 20 - Fax: +66 2 738 96 29

<https://we-ef.com/asia>

Subject to technical changes and errors. - Generated on 23/11/2024

Light distribution	Part ID	Light source	Rated lumens	Rated input power	CRI	Weight (kg)
	102-0043	LED-24/24W / 350 mA - 3000 K	3664.7	26.5 W	80	7.00
	102-0043-70	LED-24/24W / 350 mA - 3000 K	4255.8	26.5 W	70	7.00
	102-0044	LED-24/24W / 350 mA - 4000 K	4019.4	26.5 W	80	7.00
	102-0044-70	LED-24/24W / 350 mA - 4000 K	4492.3	26.5 W	70	7.00
	102-0086	LED-24/36W / 500 mA - 2200K	4572.7	39 W	70	7.00
	102-0087	LED-24/36W / 500 mA - 2700K	4572.7	39 W	80	7.00
	102-0087-70	LED-24/36W / 500 mA - 2700K	4915.6	39 W	70	7.00
	102-0088	LED-24/36W / 500 mA - 3000 K	4915.6	39 W	80	7.00
	102-0088-70	LED-24/36W / 500 mA - 3000 K	5601.5	39 W	70	7.00
	102-0089	LED-24/36W / 500 mA - 4000 K	5258.6	39 W	80	7.00
	102-0089-70	LED-24/36W / 500 mA - 4000 K	5944.5	39 W	70	7.00
	102-0131	LED-24/48W / 700 mA - 2200 K	6173.1	54 W	70	7.00
	102-0132	LED-24/48W / 700 mA - 2700 K	6173.1	54 W	80	7.00
	102-0132-70	LED-24/48W / 700 mA - 2700 K	6630.4	54 W	70	7.00
	102-0133	LED-24/48W / 700 mA - 3000 K	6630.4	54 W	80	7.00
	102-0133-70	LED-24/48W / 700 mA - 3000 K	7544.9	54 W	70	7.00
	102-0134	LED-24/48W / 700 mA - 4000 K	7087.6	54 W	80	7.00
	102-0134-70	LED-24/48W / 700 mA - 4000 K	8002.2	54 W	70	7.00
	102-0892	LED-24/72W / 1050 mA - 2200 K	8106.7	81 W	70	7.00
	102-0893	LED-24/72W / 1050 mA - 2700 K	8106.7	81 W	80	7.00
102-0893-70	LED-24/72W / 1050 mA - 2700 K	8755.3	81 W	70	7.00	
102-0894	LED-24/72W / 1050 mA - 3000 K	8755.3	81 W	80	7.00	
102-0894-70	LED-24/72W / 1050 mA - 3000 K	9944.3	81 W	70	7.00	
102-0895	LED-24/72W / 1050 mA - 4000 K	9295.7	81 W	80	7.00	
102-0895-70	LED-24/72W / 1050 mA - 4000 K	10592.8	81 W	70	7.00	
pedestrian crossing, right-hand traffic [P46R]	102-0036	LED-24/24W / 350 mA - 2200 K	3364.3	26.5 W	70	7.00
	102-0037	LED-24/24W / 350 mA - 2700 K	3364.3	26.5 W	80	7.00
	102-0037-70	LED-24/24W / 350 mA - 2700 K	3596.3	26.5 W	70	7.00
	102-0038	LED-24/24W / 350 mA - 3000 K	3596.3	26.5 W	80	7.00
	102-0038-70	LED-24/24W / 350 mA - 3000 K	4176.3	26.5 W	70	7.00
	102-0039	LED-24/24W / 350 mA - 4000 K	3944.3	26.5 W	80	7.00
	102-0039-70	LED-24/24W / 350 mA - 4000 K	4408.3	26.5 W	70	7.00
	102-0081	LED-24/36W / 500 mA - 2200K	4419.5	39 W	70	7.00
	102-0082	LED-24/36W / 500 mA - 2700K	4419.5	39 W	80	7.00
	102-0082-70	LED-24/36W / 500 mA - 2700K	4751	39 W	70	7.00
102-0083	LED-24/36W / 500 mA - 3000 K	4751	39 W	80	7.00	



Light distribution	Part ID	Light source	Rated lumens	Rated input power	CRI	Weight (kg)
	102-0083-70	LED-24/36W / 500 mA - 3000 K	5413.9	39 W	70	7.00
	102-0084	LED-24/36W / 500 mA - 4000 K	5082.5	39 W	80	7.00
	102-0084-70	LED-24/36W / 500 mA - 4000 K	5745.4	39 W	70	7.00
	102-0126	LED-24/48W / 700 mA - 2200 K	5966.4	54 W	70	7.00
	102-0127	LED-24/48W / 700 mA - 2700 K	5966.4	54 W	80	7.00
	102-0127-70	LED-24/48W / 700 mA - 2700 K	6408.3	54 W	70	7.00
	102-0128	LED-24/48W / 700 mA - 3000 K	6408.3	54 W	80	7.00
	102-0128-70	LED-24/48W / 700 mA - 3000 K	7292.2	54 W	70	7.00
	102-0129	LED-24/48W / 700 mA - 4000 K	6850.3	54 W	80	7.00
	102-0129-70	LED-24/48W / 700 mA - 4000 K	7734.2	54 W	70	7.00
	102-0888	LED-24/72W / 1050 mA - 2200 K	7955.3	81 W	70	7.00
	102-0889	LED-24/72W / 1050 mA - 2700 K	7955.3	81 W	80	7.00
	102-0889-70	LED-24/72W / 1050 mA - 2700 K	8591.7	81 W	70	7.00
	102-0890	LED-24/72W / 1050 mA - 3000 K	8591.7	81 W	80	7.00
	102-0890-70	LED-24/72W / 1050 mA - 3000 K	9758.5	81 W	70	7.00
	102-0891	LED-24/72W / 1050 mA - 4000 K	9122.1	81 W	80	7.00
	102-0891-70	LED-24/72W / 1050 mA - 4000 K	10394.9	81 W	70	7.00
pedestrian/bicycle lane [P66]	102-0021	LED-24/24W / 350 mA - 2200 K	3059.5	26.5 W	70	7.00
	102-0022	LED-24/24W / 350 mA - 2700 K	3059.5	26.5 W	80	7.00
	102-0022-70	LED-24/24W / 350 mA - 2700 K	3270.5	26.5 W	70	7.00
	102-0023	LED-24/24W / 350 mA - 3000 K	3270.5	26.5 W	80	7.00
	102-0023-70	LED-24/24W / 350 mA - 3000 K	3798	26.5 W	70	7.00
	102-0024	LED-24/24W / 350 mA - 4000 K	3587	26.5 W	80	7.00
	102-0024-70	LED-24/24W / 350 mA - 4000 K	4009	26.5 W	70	7.00
	102-0066	LED-24/36W / 500 mA - 2200K	4019.2	39 W	70	7.00
	102-0067	LED-24/36W / 500 mA - 2700K	4019.2	39 W	80	7.00
	102-0067-70	LED-24/36W / 500 mA - 2700K	4320.6	39 W	70	7.00
	102-0068	LED-24/36W / 500 mA - 3000 K	4320.6	39 W	80	7.00
	102-0068-70	LED-24/36W / 500 mA - 3000 K	4923.5	39 W	70	7.00
	102-0069	LED-24/36W / 500 mA - 4000 K	4622.1	39 W	80	7.00
	102-0069-70	LED-24/36W / 500 mA - 4000 K	5224.9	39 W	70	7.00
	102-0111	LED-24/48W / 700 mA - 2200 K	5425.9	54 W	70	7.00
	102-0112	LED-24/48W / 700 mA - 2700 K	5425.9	54 W	80	7.00
	102-0112-70	LED-24/48W / 700 mA - 2700 K	5827.8	54 W	70	7.00
	102-0113	LED-24/48W / 700 mA - 3000 K	5827.8	54 W	80	7.00
	102-0113-70	LED-24/48W / 700 mA - 3000 K	6631.7	54 W	70	7.00

pedestrian/bicycle lane [P66]

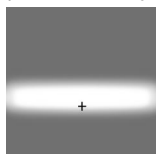

# AFL120 LED

## Pole mounted

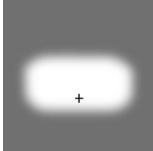
Light distribution	Part ID	Light source	Rated lumens	Rated input power	CRI	Weight (kg)
	102-0114	LED-24/48W / 700 mA - 4000 K	6229.7	54 W	80	7.00
	102-0114-70	LED-24/48W / 700 mA - 4000 K	7033.6	54 W	70	7.00
	102-0876	LED-24/72W / 1050 mA - 2200 K	7234.7	81 W	70	7.00
	102-0877	LED-24/72W / 1050 mA - 2700 K	7234.7	81 W	80	7.00
	102-0877-70	LED-24/72W / 1050 mA - 2700 K	7813.4	81 W	70	7.00
	102-0878	LED-24/72W / 1050 mA - 3000 K	7813.4	81 W	80	7.00
	102-0878-70	LED-24/72W / 1050 mA - 3000 K	8874.5	81 W	70	7.00
	102-0879	LED-24/72W / 1050 mA - 4000 K	8295.7	81 W	80	7.00
	102-0879-70	LED-24/72W / 1050 mA - 4000 K	9453.3	81 W	70	7.00
rectangular, side throw [R60]	102-0016	LED-24/24W / 350 mA - 2200 K	3005.7	26.5 W	70	7.00
	102-0017	LED-24/24W / 350 mA - 2700 K	3005.7	26.5 W	80	7.00
	102-0017-70	LED-24/24W / 350 mA - 2700 K	3213	26.5 W	70	7.00
	102-0018	LED-24/24W / 350 mA - 3000 K	3213	26.5 W	80	7.00
	102-0018-70	LED-24/24W / 350 mA - 3000 K	3731.2	26.5 W	70	7.00
	102-0019	LED-24/24W / 350 mA - 4000 K	3524	26.5 W	80	7.00
	102-0019-70	LED-24/24W / 350 mA - 4000 K	3938.5	26.5 W	70	7.00
	102-0061	LED-24/36W / 500 mA - 2200K	4375.7	39 W	70	7.00
	102-0062	LED-24/36W / 500 mA - 2700K	4375.7	39 W	80	7.00
	102-0062-70	LED-24/36W / 500 mA - 2700K	4703.9	39 W	70	7.00
	102-0063	LED-24/36W / 500 mA - 3000 K	4703.9	39 W	80	7.00
	102-0063-70	LED-24/36W / 500 mA - 3000 K	5360.3	39 W	70	7.00
	102-0064	LED-24/36W / 500 mA - 4000 K	5032.1	39 W	80	7.00
	102-0064-70	LED-24/36W / 500 mA - 4000 K	5688.4	39 W	70	7.00
	102-0106	LED-24/48W / 700 mA - 2200 K	5907.2	54 W	70	7.00
	102-0107	LED-24/48W / 700 mA - 2700 K	5907.2	54 W	80	7.00
	102-0107-70	LED-24/48W / 700 mA - 2700 K	6344.8	54 W	70	7.00
	102-0108	LED-24/48W / 700 mA - 3000 K	6344.8	54 W	80	7.00
	102-0108-70	LED-24/48W / 700 mA - 3000 K	7219.9	54 W	70	7.00
	102-0109	LED-24/48W / 700 mA - 4000 K	6782.4	54 W	80	7.00
	102-0109-70	LED-24/48W / 700 mA - 4000 K	7657.5	54 W	70	7.00
	102-0872	LED-24/72W / 1050 mA - 2200 K	7175.6	81 W	70	7.00
	102-0873	LED-24/72W / 1050 mA - 2700 K	7175.6	81 W	80	7.00
	102-0873-70	LED-24/72W / 1050 mA - 2700 K	7749.7	81 W	70	7.00
	102-0874	LED-24/72W / 1050 mA - 3000 K	7749.7	81 W	80	7.00
	102-0874-70	LED-24/72W / 1050 mA - 3000 K	7749.7	81 W	70	7.00
	102-0875	LED-24/72W / 1050 mA - 4000 K	8228.1	81 W	80	7.00

**WE-EF LIGHTING (Thailand) Co., Ltd.**

57 Moo 5, Kingkaew Rd., Bangplee, 10540 Samutprakarn - Phone: +66 2 738 96 20 - Fax: +66 2 738 96 29

<https://we-ef.com/asia>

Subject to technical changes and errors. - Generated on 23/11/2024

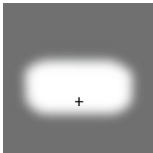
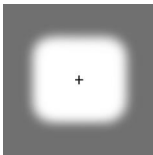
Light distribution	Part ID	Light source	Rated lumens	Rated input power	CRI	Weight (kg)
	102-0875-70	LED-24/72W / 1050 mA - 4000 K	9376.2	81 W	70	7.00
rectangular, side throw [R61] 	102-0316	LED-24/24W / 350 mA - 2200 K	2982.9	26.5 W	70	7.00
	102-0317	LED-24/24W / 350 mA - 2700 K	2982.9	26.5 W	80	7.00
	102-0317-70	LED-24/24W / 350 mA - 2700 K	3188.6	26.5 W	70	7.00
	102-0318	LED-24/24W / 350 mA - 3000 K	3188.6	26.5 W	80	7.00
	102-0318-70	LED-24/24W / 350 mA - 3000 K	3702.9	26.5 W	70	7.00
	102-0319	LED-24/24W / 350 mA - 4000 K	3497.2	26.5 W	80	7.00
	102-0319-70	LED-24/24W / 350 mA - 4000 K	3908.6	26.5 W	70	7.00
	102-0328	LED-24/36W / 500 mA - 2200K	3918.5	39 W	70	7.00
	102-0329	LED-24/36W / 500 mA - 2700K	3918.5	39 W	80	7.00
	102-0329-70	LED-24/36W / 500 mA - 2700K	4212.4	39 W	70	7.00
	102-0330	LED-24/36W / 500 mA - 3000 K	4212.4	39 W	80	7.00
	102-0330-70	LED-24/36W / 500 mA - 3000 K	4800.2	39 W	70	7.00
	102-0331	LED-24/36W / 500 mA - 4000 K	4506.3	39 W	80	7.00
	102-0331-70	LED-24/36W / 500 mA - 4000 K	5094.1	39 W	70	7.00
	102-0340	LED-24/48W / 700 mA - 2200 K	5290	54 W	70	7.00
	102-0341	LED-24/48W / 700 mA - 2700 K	5290	54 W	80	7.00
	102-0341-70	LED-24/48W / 700 mA - 2700 K	5681.9	54 W	70	7.00
	102-0342	LED-24/48W / 700 mA - 3000 K	5681.9	54 W	80	7.00
	102-0342-70	LED-24/48W / 700 mA - 3000 K	6465.6	54 W	70	7.00
	102-0343	LED-24/48W / 700 mA - 4000 K	6073.7	54 W	80	7.00
	102-0343-70	LED-24/48W / 700 mA - 4000 K	6857.4	54 W	70	7.00
	102-0904	LED-24/72W / 1050 mA - 2200 K	7053.5	81 W	70	7.00
	102-0905	LED-24/72W / 1050 mA - 2700 K	7053.5	81 W	80	7.00
	102-0905-70	LED-24/72W / 1050 mA - 2700 K	7617.8	81 W	70	7.00
	102-0906	LED-24/72W / 1050 mA - 3000 K	7617.8	81 W	80	7.00
	102-0906-70	LED-24/72W / 1050 mA - 3000 K	8652.3	81 W	70	7.00
	102-0907	LED-24/72W / 1050 mA - 4000 K	8088	81 W	80	7.00
102-0907-70	LED-24/72W / 1050 mA - 4000 K	9216.6	81 W	70	7.00	
square distribution [Q66] 	102-0031	LED-24/24W / 350 mA - 2200 K	3045.3	26.5 W	70	7.00
	102-0032	LED-24/24W / 350 mA - 2700 K	3045.3	26.5 W	80	7.00
	102-0032-70	LED-24/24W / 350 mA - 2700 K	3255.4	26.5 W	70	7.00
	102-0033	LED-24/24W / 350 mA - 3000 K	3255.4	26.5 W	80	7.00
	102-0033-70	LED-24/24W / 350 mA - 3000 K	3780.4	26.5 W	70	7.00
	102-0034	LED-24/24W / 350 mA - 4000 K	3570.4	26.5 W	80	7.00
	102-0034-70	LED-24/24W / 350 mA - 4000 K	3990.5	26.5 W	70	7.00

Light distribution	Part ID	Light source	Rated lumens	Rated input power	CRI	Weight (kg)
	102-0076	LED-24/36W / 500 mA - 2200K	4000.6	39 W	70	7.00
	102-0077	LED-24/36W / 500 mA - 2700K	4000.6	39 W	80	7.00
	102-0077-70	LED-24/36W / 500 mA - 2700K	4300.6	39 W	70	7.00
	102-0078	LED-24/36W / 500 mA - 3000 K	4300.6	39 W	80	7.00
	102-0078-70	LED-24/36W / 500 mA - 3000 K	4900.7	39 W	70	7.00
	102-0079	LED-24/36W / 500 mA - 4000 K	4600.7	39 W	80	7.00
	102-0079-70	LED-24/36W / 500 mA - 4000 K	5200.8	39 W	70	7.00
	102-0121	LED-24/48W / 700 mA - 2200 K	5400.8	54 W	70	7.00
	102-0122	LED-24/48W / 700 mA - 2700 K	5400.8	54 W	80	7.00
	102-0122-70	LED-24/48W / 700 mA - 2700 K	5800.9	54 W	70	7.00
	102-0123	LED-24/48W / 700 mA - 3000 K	5800.9	54 W	80	7.00
	102-0123-70	LED-24/48W / 700 mA - 3000 K	6601	54 W	70	7.00
	102-0124	LED-24/48W / 700 mA - 4000 K	6200.9	54 W	80	7.00
	102-0124-70	LED-24/48W / 700 mA - 4000 K	7001.1	54 W	70	7.00
	102-0884	LED-24/72W / 1050 mA - 2200 K	7201.3	81 W	70	7.00
	102-0885	LED-24/72W / 1050 mA - 2700 K	7201.3	81 W	80	7.00
	102-0885-70	LED-24/72W / 1050 mA - 2700 K	7777.4	81 W	70	7.00
	102-0886	LED-24/72W / 1050 mA - 3000 K	7777.4	81 W	80	7.00
	102-0886-70	LED-24/72W / 1050 mA - 3000 K	8833.5	81 W	70	7.00
	102-0887	LED-24/72W / 1050 mA - 4000 K	8257.4	81 W	80	7.00
	102-0887-70	LED-24/72W / 1050 mA - 4000 K	9409.6	81 W	70	7.00

**Optical Accessories****Backlight shield**

Description	Part ID	Additional information
Backlight shield LS180	102-0959-24LED	Glare Shield for backlight spill. Suitable for [S65] [R60] lenses. Glare Shield factory-installed or available as retrofit kit. Must be specified at time of ordering.

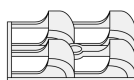

Backlight shield LS180	102-0395-24LED	Glare Shield for backlight spill. Suitable for [S61], [S66], [R61], [P66] [Q66], [A61] lenses. Glare Shield factory-installed or available as retrofit kit. Must be specified at time of ordering.
------------------------	----------------	---

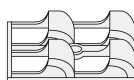

# AFL120 LED

Pole mounted

**we-ef**

## Control

### Eco Step Dim

Description	Part ID
ECO Step Dim® Motion LED	400-0044
Eco Step Dim® Advanced LED	430-0002

### R2C Ready to Connect

Description	Part ID
R2C Ready to Connect (top)	430-0019
R2C Ready to Connect (below)	430-0027
R2C Ready to Connect (top and below)	430-0032

**WE-EF LIGHTING (Thailand) Co., Ltd.**

57 Moo 5, Kingkaew Rd., Bangplee, 10540 Samutprakarn - Phone: +66 2 738 96 20 - Fax: +66 2 738 96 29

<https://we-ef.com/asia>

Subject to technical changes and errors. - Generated on 23/11/2024

**Mounting Accessories****Bird deterrent**

---

Description	Part ID
Bird deterrent BD	430-0015

---

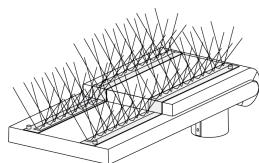

---

**Adaptor**

---

Description	Part ID
Adaptor AFL100	102-0392

---

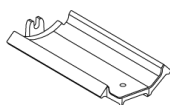

### Wall and pole brackets RE

Description	Part ID	C1	D1	D2	D × L1	H1	M1	Weight (kg)
Pole bracket RE2-540, double	111-0043	200			76 x 130	550		5.30

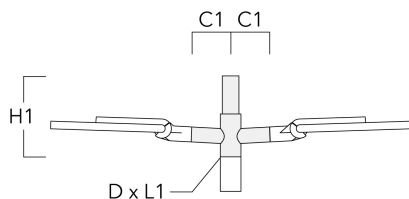

Wall bracket RE0-540	111-0084	180	230	195		12	3.20	
----------------------	----------	-----	-----	-----	--	----	------	--

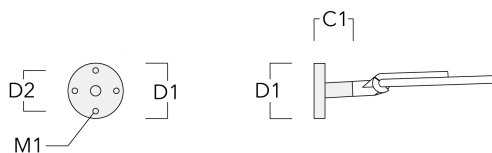



## Pole mounted

Description	Part ID	C1	D1	D2	D × L1	H1	M1	Weight (kg)
RE1-540 Pole bracket, single	111-0042	200			76 x 130	500		4.60

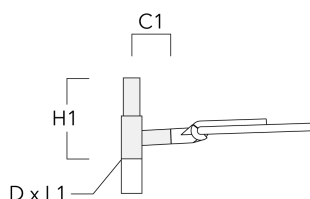

## Pole brackets RF

Description	Part ID	C1	D × L1	H1	Weight (kg)
Pole bracket RF2-540, double	111-0047	200	76 x 80	200	3.30

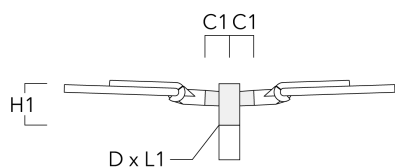

Description	Part ID	C1	D × L1	H1	Weight (kg)
RF1-540 Pole bracket, single	111-0046	200	76 x 80	200	2.60

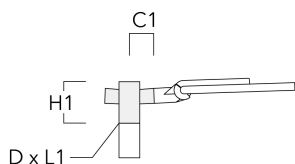

### Wall and pole brackets RX

Description	Part ID	C1	D1	D2	D × L1	H1	H2	M1	M2	Weight (kg)
RX1-540 Pole bracket, single	111-0054	1000			76 x 130	550				6.8

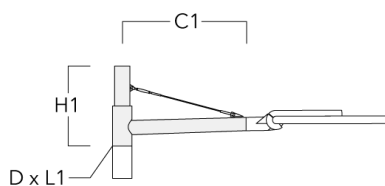

# AFL120 LED

## Pole mounted

Description	Part ID	C1	D1	D2	D × L1	H1	H2	M1	M2	Weight (kg)
RX2-540 Pole bracket, double	111-0055	1000			76 x 130	550				9.70

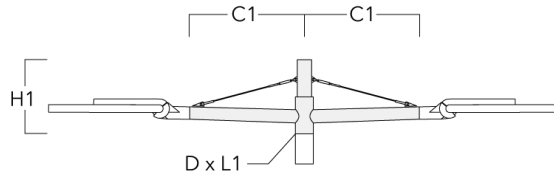

RX0-540 Wall bracket	111-0086	1000	140	100		450	385	30	12	5.20
----------------------	----------	------	-----	-----	--	-----	-----	----	----	------

