

AFL130 LED

Street and Area Lighting

we-ef

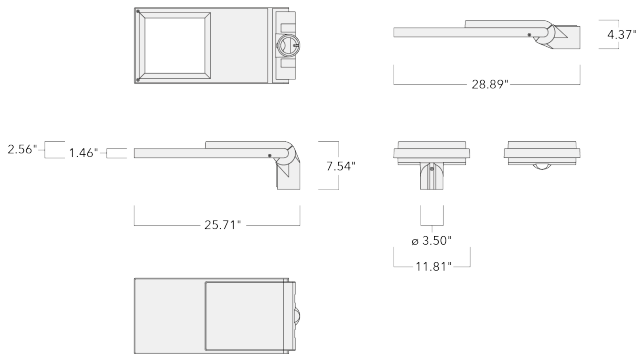

Description

IP66, Class I or Class II. IK08. Marine-grade, die-cast aluminium alloy. 5CE superior corrosion protection including PCS hardware. CCG® Controlled Compression Gasket. Non-reflective flat safety glass cover, hinged. Integral EC electronic converter. CAD-optimised optics for superior illumination and glare control. OLC® One LED Concept. Factory installed LED circuit board. The luminaire is factory-sealed and does not need to be opened during installation. Can be used as post top or side entry version. Specification at time of order is recommended.

Spigot Ø 3" x 4"





Contact WE-EF direct or your local WE-EF sales representative for an individual solution designed to precisely meet your needs.

For DarkSky compliant configurations of this product, please find the spec sheet and DarkSky certificate in the library.

WE-EF LIGHTING USA, LLC

410-D Keystone Drive, 15086 Warrendale, PA 15086 - Phone: +1 724 742 0030
customersupport.usa@we-ef.com - <https://we-ef.com/us>
Subject to technical changes and errors. - Generated on 11/23/2024

Specifications**Material description**

Body	Marine-grade, die-cast aluminium alloy
Lens	Non-reflective safety glass lens
Colors	 RAL9004 Black  RAL9007 Grey Metallic  RAL9016 White  RAL8019 Dark Bronze
Gasket	CCG® Controlled Compression Gasket
Fasteners	PCS Polymer Coated Stainless Steel Hardware
Ingress protection	IP66
Impact resistance	IK08
Corrosion resistance	5CE
Windage	0.1956 m ²

Electrical description

Driver / Ballast	Integral EC electronic converter. 0-10V
Power factor	> 0.9
Surge protection	6/6kV, optional 10kV

Additional information

Lifetime	Ta=25°/40° L90B10 > 90000h
----------	----------------------------

AFL130 LED

Street and Area Lighting

Options

Light distribution



[S61] Type III Short



[S65] Type III Medium



[S70] Type II Short



rectangular, side throw [R60]



[P66] Type II Medium



[A61] Type IV Very Short



square distribution [Q66]



pedestrian crossing, right-hand traffic [P46R]



pedestrian crossing, left-hand traffic [P46L]



asymmetric, side throw beam [S66]



asymmetric, side throw [S71]



rectangular, side throw [R61]

Color temperature

Nominal Watt



2200 K



2700 K



3000 K



4000 K

24 W

WE-EF LIGHTING USA, LLC

410-D Keystone Drive, 15086 Warrendale, PA 15086 - Phone: +1 724 742 0030

customersupport.usa@we-ef.com - <https://we-ef.com/us>

Subject to technical changes and errors. - Generated on 11/23/2024

Configurations

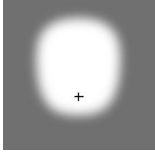
Light distribution	Part ID	Light source	Rated lumens	Rated input power	CRI	Weight (lb)
[A61] Type IV Very Short 	102-0179	LED-48/48W / 350 mA - 2200 K	6099.6	52 W	70	19
	102-0180	LED-48/48W / 350 mA - 2700 K	6099.6	52 W	80	19
	102-0180-70	LED-48/48W / 350 mA - 2700 K	6520.3	52 W	70	19
	102-0181	LED-48/48W / 350 mA - 3000 K	6520.3	52 W	80	19
	102-0181-70	LED-48/48W / 350 mA - 3000 K	7572	52 W	70	19
	102-0182	LED-48/48W / 350 mA - 4000 K	7151.3	52 W	80	19
	102-0182-70	LED-48/48W / 350 mA - 4000 K	7992.6	52 W	70	19
	102-0224	LED-48/72W / 500 mA - 2200 K	8750.8	77 W	70	19
	102-0225	LED-48/72W / 500 mA - 2700 K	8750.8	77 W	80	19
	102-0225-70	LED-48/72W / 500 mA - 2700 K	9407.1	77 W	70	19
	102-0226	LED-48/72W / 500 mA - 3000 K	9407.1	77 W	80	19
	102-0226-70	LED-48/72W / 500 mA - 3000 K	10719.7	77 W	70	19
	102-0227	LED-48/72W / 500 mA - 4000 K	10063.4	77 W	80	19
	102-0227-70	LED-48/72W / 500 mA - 4000 K	11376	77 W	70	19
	102-0269	LED-48/96W / 700 mA - 2200 K	11813.6	105.5 W	70	19
	102-0270	LED-48/96W / 700 mA - 2700 K	11813.6	105.5 W	80	19
	102-0270-70	LED-48/96W / 700 mA - 2700 K	12688.6	105.5 W	70	19
	102-0271	LED-48/96W / 700 mA - 3000 K	12688.6	105.5 W	80	19
	102-0271-70	LED-48/96W / 700 mA - 3000 K	14438.8	105.5 W	70	19
	102-0272	LED-48/96W / 700 mA - 4000 K	13563.7	105.5 W	80	19
	102-0272-70	LED-48/96W / 700 mA - 4000 K	15313.9	105.5 W	70	19
	102-0928	LED-48/144W / 1050 mA - 2200 K	14423.1	159 W	70	19
	102-0929	LED-48/144W / 1050 mA - 2700 K	14423.1	159 W	80	19
	102-0929-70	LED-48/144W / 1050 mA - 2700 K	18077	159 W	70	19
	102-0930	LED-48/144W / 1050 mA - 3000 K	15577	159 W	80	19
	102-0930-70	LED-48/144W / 1050 mA - 3000 K	18846.2	159 W	70	19
	102-0931	LED-48/144W / 1050 mA - 4000 K	16538.5	159 W	80	19
102-0931-70	LED-48/144W / 1050 mA - 4000 K	19615.5	159 W	70	19	
[P66] Type II Medium	102-0174	LED-48/48W / 350 mA - 2200 K	6167.1	52 W	70	19
	102-0175	LED-48/48W / 350 mA - 2700 K	6167.1	52 W	80	19
	102-0175-70	LED-48/48W / 350 mA - 2700 K	6592.4	52 W	70	19
	102-0176	LED-48/48W / 350 mA - 3000 K	6592.4	52 W	80	19

WE-EF LIGHTING USA, LLC

410-D Keystone Drive, 15086 Warrendale, PA 15086 - Phone: +1 724 742 0030
 customersupport.usa@we-ef.com - <https://we-ef.com/us>

Subject to technical changes and errors. - Generated on 11/23/2024

Street and Area Lighting

Light distribution	Part ID	Light source	Rated lumens	Rated input power	CRI	Weight (lb)	
	102-0176-70	LED-48/48W / 350 mA - 3000 K	7655.7	52 W	70	19	
	102-0177	LED-48/48W / 350 mA - 4000 K	7230.4	52 W	80	19	
	102-0177-70	LED-48/48W / 350 mA - 4000 K	8081	52 W	70	19	
	102-0219	LED-48/72W / 500 mA - 2200 K	8459.9	77 W	70	19	
	102-0220	LED-48/72W / 500 mA - 2700 K	8459.9	77 W	80	19	
	102-0220-70	LED-48/72W / 500 mA - 2700 K	9094.4	77 W	70	19	
	102-0221	LED-48/72W / 500 mA - 3000 K	9094.4	77 W	80	19	
	102-0221-70	LED-48/72W / 500 mA - 3000 K	10363.4	77 W	70	19	
	102-0222	LED-48/72W / 500 mA - 4000 K	9728.9	77 W	80	19	
	102-0222-70	LED-48/72W / 500 mA - 4000 K	10997.9	77 W	70	19	
	102-0264	LED-48/96W / 700 mA - 2200 K	11420.9	105.5 W	70	19	
	102-0265	LED-48/96W / 700 mA - 2700 K	11420.9	105.5 W	80	19	
	102-0265-70	LED-48/96W / 700 mA - 2700 K	12266.9	105.5 W	70	19	
	102-0266	LED-48/96W / 700 mA - 3000 K	12266.9	105.5 W	80	19	
	102-0266-70	LED-48/96W / 700 mA - 3000 K	13958.9	105.5 W	70	19	
	102-0267	LED-48/96W / 700 mA - 4000 K	13112.9	105.5 W	80	19	
	102-0267-70	LED-48/96W / 700 mA - 4000 K	14804.8	105.5 W	70	19	
	102-0924	LED-48/144W / 1050 mA - 2200 K	14582.9	159 W	70	19	
	102-0925	LED-48/144W / 1050 mA - 2700 K	14582.9	159 W	80	19	
	102-0925-70	LED-48/144W / 1050 mA - 2700 K	18277.2	159 W	70	19	
	102-0926	LED-48/144W / 1050 mA - 3000 K	15749.5	159 W	80	19	
	102-0926-70	LED-48/144W / 1050 mA - 3000 K	19054.9	159 W	70	19	
	102-0927	LED-48/144W / 1050 mA - 4000 K	16721.7	159 W	80	19	
	102-0927-70	LED-48/144W / 1050 mA - 4000 K	19832.7	159 W	70	19	
	[S61] Type III Short	102-0154	LED-48/48W / 350 mA - 2200 K	6594.1	52 W	70	19
		102-0155	LED-48/48W / 350 mA - 2700 K	6594.1	52 W	80	19
102-0155-70		LED-48/48W / 350 mA - 2700 K	7048.9	52 W	70	19	
102-0156		LED-48/48W / 350 mA - 3000 K	7048.9	52 W	80	19	
102-0156-70		LED-48/48W / 350 mA - 3000 K	8185.8	52 W	70	19	
102-0157		LED-48/48W / 350 mA - 4000 K	7731	52 W	80	19	
102-0157-70		LED-48/48W / 350 mA - 4000 K	8640.6	52 W	70	19	
102-0199		LED-48/72W / 500 mA - 2200 K	8974.4	77 W	70	19	
102-0200		LED-48/72W / 500 mA - 2700 K	8974.4	77 W	80	19	

WE-EF LIGHTING USA, LLC

410-D Keystone Drive, 15086 Warrendale, PA 15086 - Phone: +1 724 742 0030

customersupport.usa@we-ef.com - <https://we-ef.com/us>

Subject to technical changes and errors. - Generated on 11/23/2024

Street and Area Lighting

Light distribution	Part ID	Light source	Rated lumens	Rated input power	CRI	Weight (lb)
	102-0200-70	LED-48/72W / 500 mA - 2700 K	9647.5	77 W	70	19
	102-0201	LED-48/72W / 500 mA - 3000 K	9647.5	77 W	80	19
	102-0201-70	LED-48/72W / 500 mA - 3000 K	10993.7	77 W	70	19
	102-0202	LED-48/72W / 500 mA - 4000 K	10320.6	77 W	80	19
	102-0202-70	LED-48/72W / 500 mA - 4000 K	11666.8	77 W	70	19
	102-0244	LED-48/96W / 700 mA - 2200 K	12115.5	105.5 W	70	19
	102-0245	LED-48/96W / 700 mA - 2700 K	12115.5	105.5 W	80	19
	102-0245-70	LED-48/96W / 700 mA - 2700 K	13012.9	105.5 W	70	19
	102-0246	LED-48/96W / 700 mA - 3000 K	13012.9	105.5 W	80	19
	102-0246-70	LED-48/96W / 700 mA - 3000 K	14807.8	105.5 W	70	19
	102-0247	LED-48/96W / 700 mA - 4000 K	13910.4	105.5 W	80	19
	102-0247-70	LED-48/96W / 700 mA - 4000 K	15705.3	105.5 W	70	19
	102-0908	LED-48/144W / 1050 mA - 2200 K	15592.5	159 W	70	19
	102-0909	LED-48/144W / 1050 mA - 2700 K	15592.5	159 W	80	19
	102-0909-70	LED-48/144W / 1050 mA - 2700 K	19542.6	159 W	70	19
	102-0910	LED-48/144W / 1050 mA - 3000 K	16839.9	159 W	80	19
	102-0910-70	LED-48/144W / 1050 mA - 3000 K	20374.2	159 W	70	19
	102-0911	LED-48/144W / 1050 mA - 4000 K	17879.4	159 W	80	19
	102-0911-70	LED-48/144W / 1050 mA - 4000 K	21205.8	159 W	70	19
[S65] Type III Medium	102-0159	LED-48/48W / 350 mA - 2200 K	6361.8	52 W	70	19
	102-0160	LED-48/48W / 350 mA - 2700 K	6361.8	52 W	80	19
	102-0160-70	LED-48/48W / 350 mA - 2700 K	6800.6	52 W	70	19
	102-0161	LED-48/48W / 350 mA - 3000 K	6800.6	52 W	80	19
	102-0161-70	LED-48/48W / 350 mA - 3000 K	7897.5	52 W	70	19
	102-0162	LED-48/48W / 350 mA - 4000 K	7458.7	52 W	80	19
	102-0162-70	LED-48/48W / 350 mA - 4000 K	8336.2	52 W	70	19
	102-0204	LED-48/72W / 500 mA - 2200 K	8774.9	77 W	70	19
	102-0205	LED-48/72W / 500 mA - 2700 K	8774.9	77 W	80	19
	102-0205-70	LED-48/72W / 500 mA - 2700 K	9433.1	77 W	70	19
	102-0206	LED-48/72W / 500 mA - 3000 K	9433.1	77 W	80	19
	102-0206-70	LED-48/72W / 500 mA - 3000 K	10749.3	77 W	70	19
	102-0207	LED-48/72W / 500 mA - 4000 K	10091.2	77 W	80	19
	102-0207-70	LED-48/72W / 500 mA - 4000 K	11407.4	77 W	70	19

WE-EF LIGHTING USA, LLC

410-D Keystone Drive, 15086 Warrendale, PA 15086 - Phone: +1 724 742 0030

customersupport.usa@we-ef.com - <https://we-ef.com/us>

Subject to technical changes and errors. - Generated on 11/23/2024

Street and Area Lighting

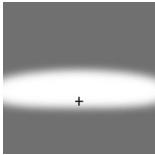
Light distribution	Part ID	Light source	Rated lumens	Rated input power	CRI	Weight (lb)
	102-0249	LED-48/96W / 700 mA - 2200 K	11846.2	105.5 W	70	19
	102-0250	LED-48/96W / 700 mA - 2700 K	11846.2	105.5 W	80	19
	102-0250-70	LED-48/96W / 700 mA - 2700 K	12723.7	105.5 W	70	19
	102-0251	LED-48/96W / 700 mA - 3000 K	12723.7	105.5 W	80	19
	102-0251-70	LED-48/96W / 700 mA - 3000 K	14478.7	105.5 W	70	19
	102-0252	LED-48/96W / 700 mA - 4000 K	13601.2	105.5 W	80	19
	102-0252-70	LED-48/96W / 700 mA - 4000 K	15356.2	105.5 W	70	19
	102-0912	LED-48/144W / 1050 mA - 2200 K	15795.2	159 W	70	19
	102-0913	LED-48/144W / 1050 mA - 2700 K	15795.2	159 W	80	19
	102-0913-70	LED-48/144W / 1050 mA - 2700 K	19796.6	159 W	70	19
	102-0914	LED-48/144W / 1050 mA - 3000 K	17058.8	159 W	80	19
	102-0914-70	LED-48/144W / 1050 mA - 3000 K	20639.1	159 W	70	19
	102-0915	LED-48/144W / 1050 mA - 4000 K	18111.8	159 W	80	19
	102-0915-70	LED-48/144W / 1050 mA - 4000 K	21481.5	159 W	70	19
[S70] Type II Short	102-0164	LED-48/48W / 350 mA - 2200 K	6600.9	52 W	70	19
	102-0165	LED-48/48W / 350 mA - 2700 K	6600.9	52 W	80	19
	102-0165-70	LED-48/48W / 350 mA - 2700 K	7056.1	52 W	70	19
	102-0166	LED-48/48W / 350 mA - 3000 K	7056.1	52 W	80	19
	102-0166-70	LED-48/48W / 350 mA - 3000 K	8194.2	52 W	70	19
	102-0167	LED-48/48W / 350 mA - 4000 K	7739	52 W	80	19
	102-0167-70	LED-48/48W / 350 mA - 4000 K	8649.4	52 W	70	19
	102-0209	LED-48/72W / 500 mA - 2200 K	8875.3	77 W	70	19
	102-0210	LED-48/72W / 500 mA - 2700 K	8875.3	77 W	80	19
	102-0210-70	LED-48/72W / 500 mA - 2700 K	9541	77 W	70	19
	102-0211	LED-48/72W / 500 mA - 3000 K	9541	77 W	80	19
	102-0211-70	LED-48/72W / 500 mA - 3000 K	10872.3	77 W	70	19
	102-0212	LED-48/72W / 500 mA - 4000 K	10206.6	77 W	80	19
	102-0212-70	LED-48/72W / 500 mA - 4000 K	11537.9	77 W	70	19
	102-0254	LED-48/96W / 700 mA - 2200 K	11981.7	105.5 W	70	19
	102-0255	LED-48/96W / 700 mA - 2700 K	11981.7	105.5 W	80	19
	102-0255-70	LED-48/96W / 700 mA - 2700 K	12869.2	105.5 W	70	19
	102-0256	LED-48/96W / 700 mA - 3000 K	12869.2	105.5 W	80	19
	102-0256-70	LED-48/96W / 700 mA - 3000 K	14644.3	105.5 W	70	19

WE-EF LIGHTING USA, LLC

410-D Keystone Drive, 15086 Warrendale, PA 15086 - Phone: +1 724 742 0030

customersupport.usa@we-ef.com - <https://we-ef.com/us>

Subject to technical changes and errors. - Generated on 11/23/2024

Street and Area Lighting

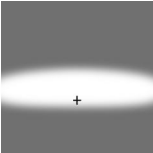
Light distribution	Part ID	Light source	Rated lumens	Rated input power	CRI	Weight (lb)
	102-0257	LED-48/96W / 700 mA - 4000 K	13756.8	105.5 W	80	19
	102-0257-70	LED-48/96W / 700 mA - 4000 K	15531.8	105.5 W	70	19
	102-0916	LED-48/144W / 1050 mA - 2200 K	15608.5	159 W	70	19
	102-0917	LED-48/144W / 1050 mA - 2700 K	15608.5	159 W	80	19
	102-0917-70	LED-48/144W / 1050 mA - 2700 K	19562.6	159 W	70	19
	102-0918	LED-48/144W / 1050 mA - 3000 K	16857.1	159 W	80	19
	102-0918-70	LED-48/144W / 1050 mA - 3000 K	20395	159 W	70	19
	102-0919	LED-48/144W / 1050 mA - 4000 K	17897.7	159 W	80	19
	102-0919-70	LED-48/144W / 1050 mA - 4000 K	21227.5	159 W	70	19
asymmetric, side throw [S71]	102-0354	LED-48/48W / 350 mA - 2200 K	6025.3	52 W	70	19
	102-0355	LED-48/48W / 350 mA - 2700 K	6025.3	52 W	80	19
	102-0355-70	LED-48/48W / 350 mA - 2700 K	6440.8	52 W	70	19
	102-0356	LED-48/48W / 350 mA - 3000 K	6440.8	52 W	80	19
	102-0356-70	LED-48/48W / 350 mA - 3000 K	7479.6	52 W	70	19
	102-0357	LED-48/48W / 350 mA - 4000 K	7064.1	52 W	80	19
	102-0357-70	LED-48/48W / 350 mA - 4000 K	7895.2	52 W	70	19
	102-0366	LED-48/72W / 500 mA - 2200 K	7915.2	77 W	70	19
	102-0367	LED-48/72W / 500 mA - 2700 K	7915.2	77 W	80	19
	102-0367-70	LED-48/72W / 500 mA - 2700 K	8508.9	77 W	70	19
	102-0368	LED-48/72W / 500 mA - 3000 K	8508.9	77 W	80	19
	102-0368-70	LED-48/72W / 500 mA - 3000 K	9696.1	77 W	70	19
	102-0369	LED-48/72W / 500 mA - 4000 K	9102.5	77 W	80	19
	102-0369-70	LED-48/72W / 500 mA - 4000 K	10289.8	77 W	70	19
	102-0378	LED-48/96W / 700 mA - 2200 K	10685.5	105.5 W	70	19
	102-0379	LED-48/96W / 700 mA - 2700 K	10685.5	105.5 W	80	19
	102-0379-70	LED-48/96W / 700 mA - 2700 K	11477.1	105.5 W	70	19
	102-0380	LED-48/96W / 700 mA - 3000 K	11477.1	105.5 W	80	19
	102-0380-70	LED-48/96W / 700 mA - 3000 K	13060.1	105.5 W	70	19
	102-0381	LED-48/96W / 700 mA - 4000 K	12268.6	105.5 W	80	19
	102-0381-70	LED-48/96W / 700 mA - 4000 K	13851.6	105.5 W	70	19
	102-0948	LED-48/144W / 1050 mA - 2200 K	14247.6	159 W	70	19
	102-0949	LED-48/144W / 1050 mA - 2700 K	14247.6	159 W	80	19
	102-0949-70	LED-48/144W / 1050 mA - 2700 K	17857	159 W	70	19

WE-EF LIGHTING USA, LLC

410-D Keystone Drive, 15086 Warrendale, PA 15086 - Phone: +1 724 742 0030

customersupport.usa@we-ef.com - <https://we-ef.com/us>

Subject to technical changes and errors. - Generated on 11/23/2024

Street and Area Lighting

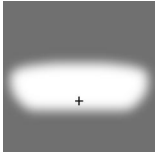
Light distribution	Part ID	Light source	Rated lumens	Rated input power	CRI	Weight (lb)
	102-0950	LED-48/144W / 1050 mA - 3000 K	15387.4	159 W	80	19
	102-0950-70	LED-48/144W / 1050 mA - 3000 K	18616.9	159 W	70	19
	102-0951	LED-48/144W / 1050 mA - 4000 K	16337.3	159 W	80	19
	102-0951-70	LED-48/144W / 1050 mA - 4000 K	19376.8	159 W	70	19
asymmetric, side throw beam [S66]	102-0350	LED-48/48W / 350 mA - 2200 K	6528.5	52 W	70	19
	102-0351	LED-48/48W / 350 mA - 2700 K	6528.5	52 W	80	19
	102-0351-70	LED-48/48W / 350 mA - 2700 K	6978.7	52 W	70	19
	102-0352	LED-48/48W / 350 mA - 3000 K	6978.7	52 W	80	19
	102-0352-70	LED-48/48W / 350 mA - 3000 K	8104.3	52 W	70	19
	102-0353	LED-48/48W / 350 mA - 4000 K	7654.1	52 W	80	19
	102-0353-70	LED-48/48W / 350 mA - 4000 K	8554.6	52 W	70	19
	102-0362	LED-48/72W / 500 mA - 2200 K	8576.2	77 W	70	19
	102-0363	LED-48/72W / 500 mA - 2700 K	8576.2	77 W	80	19
	102-0363-70	LED-48/72W / 500 mA - 2700 K	9219.4	77 W	70	19
	102-0364	LED-48/72W / 500 mA - 3000 K	9219.4	77 W	80	19
	102-0364-70	LED-48/72W / 500 mA - 3000 K	10505.9	77 W	70	19
	102-0365	LED-48/72W / 500 mA - 4000 K	9862.7	77 W	80	19
	102-0365-70	LED-48/72W / 500 mA - 4000 K	11149.1	77 W	70	19
	102-0374	LED-48/96W / 700 mA - 2200 K	11577.9	105.5 W	70	19
	102-0375	LED-48/96W / 700 mA - 2700 K	11577.9	105.5 W	80	19
	102-0375-70	LED-48/96W / 700 mA - 2700 K	12435.5	105.5 W	70	19
	102-0376	LED-48/96W / 700 mA - 3000 K	12435.5	105.5 W	80	19
	102-0376-70	LED-48/96W / 700 mA - 3000 K	14150.8	105.5 W	70	19
	102-0377	LED-48/96W / 700 mA - 4000 K	13293.2	105.5 W	80	19
	102-0377-70	LED-48/96W / 700 mA - 4000 K	15008.4	105.5 W	70	19
	102-0944	LED-48/144W / 1050 mA - 2200 K	15437.4	159 W	70	19
	102-0945	LED-48/144W / 1050 mA - 2700 K	15437.4	159 W	80	19
	102-0945-70	LED-48/144W / 1050 mA - 2700 K	19348.2	159 W	70	19
	102-0946	LED-48/144W / 1050 mA - 3000 K	16672.4	159 W	80	19
	102-0946-70	LED-48/144W / 1050 mA - 3000 K	20171.5	159 W	70	19
	102-0947	LED-48/144W / 1050 mA - 4000 K	17701.5	159 W	80	19
	102-0947-70	LED-48/144W / 1050 mA - 4000 K	20994.8	159 W	70	19
	102-0194	LED-48/48W / 350 mA - 2200 K	6704.2	52 W	70	19

WE-EF LIGHTING USA, LLC

410-D Keystone Drive, 15086 Warrendale, PA 15086 - Phone: +1 724 742 0030

customersupport.usa@we-ef.com - <https://we-ef.com/us>

Subject to technical changes and errors. - Generated on 11/23/2024

Street and Area Lighting

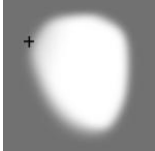
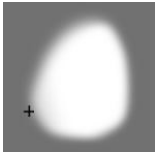
Light distribution	Part ID	Light source	Rated lumens	Rated input power	CRI	Weight (lb)
pedestrian crossing, left-hand traffic [P46L] 	102-0195	LED-48/48W / 350 mA - 2700 K	6704.2	52 W	80	19
	102-0195-70	LED-48/48W / 350 mA - 2700 K	7166.5	52 W	70	19
	102-0196	LED-48/48W / 350 mA - 3000 K	7166.5	52 W	80	19
	102-0196-70	LED-48/48W / 350 mA - 3000 K	8322.4	52 W	70	19
	102-0197	LED-48/48W / 350 mA - 4000 K	7860	52 W	80	19
	102-0197-70	LED-48/48W / 350 mA - 4000 K	8784.8	52 W	70	19
	102-0239	LED-48/72W / 500 mA - 2200 K	9145.3	77 W	70	19
	102-0240	LED-48/72W / 500 mA - 2700 K	9145.3	77 W	80	19
	102-0240-70	LED-48/72W / 500 mA - 2700 K	9831.2	77 W	70	19
	102-0241	LED-48/72W / 500 mA - 3000 K	9831.2	77 W	80	19
	102-0241-70	LED-48/72W / 500 mA - 3000 K	11203	77 W	70	19
	102-0242	LED-48/72W / 500 mA - 4000 K	10517.1	77 W	80	19
	102-0242-70	LED-48/72W / 500 mA - 4000 K	11888.9	77 W	70	19
	102-0284	LED-48/96W / 700 mA - 2200 K	12346.2	105.5 W	70	19
	102-0285	LED-48/96W / 700 mA - 2700 K	12346.2	105.5 W	80	19
	102-0285-70	LED-48/96W / 700 mA - 2700 K	13260.7	105.5 W	70	19
	102-0286	LED-48/96W / 700 mA - 3000 K	13260.7	105.5 W	80	19
	102-0286-70	LED-48/96W / 700 mA - 3000 K	15089.8	105.5 W	80	19
	102-0287	LED-48/96W / 700 mA - 4000 K	14175.3	105.5 W	80	19
	102-0287-70	LED-48/96W / 700 mA - 4000 K	16004.3	105.5 W	70	19
	102-0940	LED-48/144W / 1050 mA - 2200 K	15852.7	159 W	70	19
	102-0941	LED-48/144W / 1050 mA - 2700 K	15852.7	159 W	80	19
	102-0941-70	LED-48/144W / 1050 mA - 2700 K	19868.7	159 W	70	19
102-0942	LED-48/144W / 1050 mA - 3000 K	17120.9	159 W	80	19	
102-0942-70	LED-48/144W / 1050 mA - 3000 K	20714.2	159 W	70	19	
102-0943	LED-48/144W / 1050 mA - 4000 K	18177.8	159 W	80	19	
102-0943-70	LED-48/144W / 1050 mA - 4000 K	21559.7	159 W	70	19	
pedestrian crossing, right-hand traffic [P46R] 	102-0189	LED-48/48W / 350 mA - 2200 K	6640.5	52 W	70	19
	102-0190	LED-48/48W / 350 mA - 2700 K	6640.5	52 W	80	19
	102-0190-70	LED-48/48W / 350 mA - 2700 K	7098.4	52 W	70	19
	102-0191	LED-48/48W / 350 mA - 3000 K	7098.4	52 W	80	19
	102-0191-70	LED-48/48W / 350 mA - 3000 K	8243.3	52 W	70	19
	102-0192	LED-48/48W / 350 mA - 4000 K	7785.4	52 W	80	19

WE-EF LIGHTING USA, LLC

410-D Keystone Drive, 15086 Warrendale, PA 15086 - Phone: +1 724 742 0030

customersupport.usa@we-ef.com - <https://we-ef.com/us>

Subject to technical changes and errors. - Generated on 11/23/2024

Street and Area Lighting

Light distribution	Part ID	Light source	Rated lumens	Rated input power	CRI	Weight (lb)
	102-0192-70	LED-48/48W / 350 mA - 4000 K	8701.3	52 W	70	19
	102-0234	LED-48/72W / 500 mA - 2200 K	9016.9	77 W	70	19
	102-0235	LED-48/72W / 500 mA - 2700 K	9016.9	77 W	80	19
	102-0235-70	LED-48/72W / 500 mA - 2700 K	9693.2	77 W	70	19
	102-0236	LED-48/72W / 500 mA - 3000 K	9693.2	77 W	80	19
	102-0236-70	LED-48/72W / 500 mA - 3000 K	11045.8	77 W	70	19
	102-0237	LED-48/72W / 500 mA - 4000 K	10369.5	77 W	80	19
	102-0237-70	LED-48/72W / 500 mA - 4000 K	11722	77 W	70	19
	102-0279	LED-48/96W / 700 mA - 2200 K	12172.9	105.5 W	70	19
	102-0280	LED-48/96W / 700 mA - 2700 K	12172.9	105.5 W	80	19
	102-0280-70	LED-48/96W / 700 mA - 2700 K	13074.6	105.5 W	70	19
	102-0281	LED-48/96W / 700 mA - 3000 K	13074.6	105.5 W	80	19
	102-0281-70	LED-48/96W / 700 mA - 3000 K	14878	105.5 W	70	19
	102-0282	LED-48/96W / 700 mA - 4000 K	13976.3	105.5 W	80	19
	102-0282-70	LED-48/96W / 700 mA - 4000 K	15779.7	105.5 W	70	19
	102-0936	LED-48/144W / 1050 mA - 2200 K	15702	159 W	70	19
	102-0937	LED-48/144W / 1050 mA - 2700 K	15702	159 W	80	19
	102-0937-70	LED-48/144W / 1050 mA - 2700 K	19679.8	159 W	70	19
	102-0938	LED-48/144W / 1050 mA - 3000 K	16958.1	159 W	80	19
	102-0938-70	LED-48/144W / 1050 mA - 3000 K	20517.2	159 W	70	19
	102-0939	LED-48/144W / 1050 mA - 4000 K	18004.9	159 W	80	19
	102-0939-70	LED-48/144W / 1050 mA - 4000 K	21354.7	159 W	70	19
rectangular, side throw [R60]	102-0169	LED-48/48W / 350 mA - 2200 K	6081.9	52 W	70	19
	102-0170	LED-48/48W / 350 mA - 2700 K	6081.9	52 W	80	19
	102-0170-70	LED-48/48W / 350 mA - 2700 K	6501.4	52 W	70	19
	102-0171	LED-48/48W / 350 mA - 3000 K	6501.4	52 W	80	19
	102-0171-70	LED-48/48W / 350 mA - 3000 K	7550	52 W	70	19
	102-0172	LED-48/48W / 350 mA - 4000 K	7130.5	52 W	80	19
	102-0172-70	LED-48/48W / 350 mA - 4000 K	7969.4	52 W	70	19
	102-0214	LED-48/72W / 500 mA - 2200 K	8751.4	77 W	70	19
	102-0215	LED-48/72W / 500 mA - 2700 K	8751.4	77 W	80	19
	102-0215-70	LED-48/72W / 500 mA - 2700 K	9407.8	77 W	70	19
	102-0216	LED-48/72W / 500 mA - 3000 K	9407.8	77 W	80	19

WE-EF LIGHTING USA, LLC

410-D Keystone Drive, 15086 Warrendale, PA 15086 - Phone: +1 724 742 0030

customersupport.usa@we-ef.com - <https://we-ef.com/us>

Subject to technical changes and errors. - Generated on 11/23/2024

Street and Area Lighting

Light distribution	Part ID	Light source	Rated lumens	Rated input power	CRI	Weight (lb)
	102-0216-70	LED-48/72W / 500 mA - 3000 K	10720.5	77 W	70	19
	102-0217	LED-48/72W / 500 mA - 4000 K	10064.2	77 W	80	19
	102-0217-70	LED-48/72W / 500 mA - 4000 K	11376.9	77 W	70	19
	102-0259	LED-48/96W / 700 mA - 2200 K	11814.4	105.5 W	70	19
	102-0260	LED-48/96W / 700 mA - 2700 K	11814.4	105.5 W	80	19
	102-0260-70	LED-48/96W / 700 mA - 2700 K	12689.6	105.5 W	70	19
	102-0261	LED-48/96W / 700 mA - 3000 K	12689.6	105.5 W	80	19
	102-0261-70	LED-48/96W / 700 mA - 3000 K	14439.9	105.5 W	70	19
	102-0262	LED-48/96W / 700 mA - 4000 K	13564.7	105.5 W	80	19
	102-0262-70	LED-48/96W / 700 mA - 4000 K	15315	105.5 W	70	19
	102-0920	LED-48/144W / 1050 mA - 2200 K	14519.4	159 W	70	19
	102-0921	LED-48/144W / 1050 mA - 2700 K	14519.4	159 W	80	19
	102-0921-70	LED-48/144W / 1050 mA - 2700 K	18197.6	159 W	70	19
	102-0922	LED-48/144W / 1050 mA - 3000 K	15680.9	159 W	80	19
	102-0922-70	LED-48/144W / 1050 mA - 3000 K	18972	159 W	70	19
	102-0923	LED-48/144W / 1050 mA - 4000 K	16648.9	159 W	80	19
	102-0923-70	LED-48/144W / 1050 mA - 4000 K	19746.3	159 W	70	19
rectangular, side throw [R61]	102-0358	LED-48/48W / 350 mA - 2200 K	6039.9	52 W	70	19
	102-0359	LED-48/48W / 350 mA - 2700 K	6039.9	52 W	80	19
	102-0359-70	LED-48/48W / 350 mA - 2700 K	6456.5	52 W	70	19
	102-0360	LED-48/48W / 350 mA - 3000 K	6456.5	52 W	80	19
	102-0360-70	LED-48/48W / 350 mA - 3000 K	7497.9	52 W	70	19
	102-0361	LED-48/48W / 350 mA - 4000 K	7081.3	52 W	80	19
	102-0361-70	LED-48/48W / 350 mA - 4000 K	7914.4	52 W	70	19
	102-0370	LED-48/72W / 500 mA - 2200 K	7934.4	77 W	70	19
	102-0371	LED-48/72W / 500 mA - 2700 K	7934.4	77 W	80	19
	102-0371-70	LED-48/72W / 500 mA - 2700 K	8529.5	77 W	70	19
	102-0372	LED-48/72W / 500 mA - 3000 K	8529.5	77 W	80	19
	102-0372-70	LED-48/72W / 500 mA - 3000 K	9719.6	77 W	70	19
	102-0373	LED-48/72W / 500 mA - 4000 K	9124.5	77 W	80	19
	102-0373-70	LED-48/72W / 500 mA - 4000 K	10314.7	77 W	70	19
	102-0382	LED-48/96W / 700 mA - 2200 K	10711.4	105.5 W	70	19
	102-0383	LED-48/96W / 700 mA - 2700 K	10711.4	105.5 W	80	19

rectangular, side throw [R61]

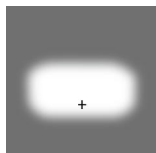

WE-EF LIGHTING USA, LLC

410-D Keystone Drive, 15086 Warrendale, PA 15086 - Phone: +1 724 742 0030

customersupport.usa@we-ef.com - <https://we-ef.com/us>

Subject to technical changes and errors. - Generated on 11/23/2024

Street and Area Lighting

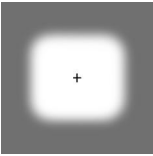
Light distribution	Part ID	Light source	Rated lumens	Rated input power	CRI	Weight (lb)
	102-0383-70	LED-48/96W / 700 mA - 2700 K	11504.9	105.5 W	70	19
	102-0384	LED-48/96W / 700 mA - 3000 K	11504.9	105.5 W	80	19
	102-0384-70	LED-48/96W / 700 mA - 3000 K	13091.7	105.5 W	70	19
	102-0385	LED-48/96W / 700 mA - 4000 K	12298.3	105.5 W	80	19
	102-0385-70	LED-48/96W / 700 mA - 4000 K	13885.2	105.5 W	70	19
	102-0952	LED-48/144W / 1050 mA - 2200 K	14282.1	159 W	70	19
	102-0953	LED-48/144W / 1050 mA - 2700 K	14282.1	159 W	80	19
	102-0953-70	LED-48/144W / 1050 mA - 2700 K	17900.2	159 W	70	19
	102-0954	LED-48/144W / 1050 mA - 3000 K	15424.7	159 W	80	19
	102-0954-70	LED-48/144W / 1050 mA - 3000 K	18661.9	159 W	70	19
	102-0955	LED-48/144W / 1050 mA - 4000 K	16376.8	159 W	80	8.6
	102-0955-70	LED-48/144W / 1050 mA - 4000 K	19423.7	159 W	70	8.6
square distribution [Q66]	102-0184	LED-48/48W / 350 mA - 2200 K	6198.8	52 W	70	19
	102-0185	LED-48/48W / 350 mA - 2700 K	6198.8	52 W	80	19
	102-0185-70	LED-48/48W / 350 mA - 2700 K	6626.3	52 W	70	19
	102-0186	LED-48/48W / 350 mA - 3000 K	6626.3	52 W	80	19
	102-0186-70	LED-48/48W / 350 mA - 3000 K	7695.1	52 W	70	19
	102-0187	LED-48/48W / 350 mA - 4000 K	7267.6	52 W	80	19
	102-0187-70	LED-48/48W / 350 mA - 4000 K	8122.6	52 W	70	19
	102-0229	LED-48/72W / 500 mA - 2200 K	8573.7	77 W	70	19
	102-0230	LED-48/72W / 500 mA - 2700 K	8573.7	77 W	80	19
	102-0230-70	LED-48/72W / 500 mA - 2700 K	9216.7	77 W	70	19
	102-0231	LED-48/72W / 500 mA - 3000 K	9216.7	77 W	80	19
	102-0231-70	LED-48/72W / 500 mA - 3000 K	10502.8	77 W	70	19
	102-0232	LED-48/72W / 500 mA - 4000 K	9859.8	77 W	80	19
	102-0232-70	LED-48/72W / 500 mA - 4000 K	11145.8	77 W	70	19
	102-0274	LED-48/96W / 700 mA - 2200 K	11574.5	105.5 W	70	19
	102-0275	LED-48/96W / 700 mA - 2700 K	11574.5	105.5 W	80	19
	102-0275-70	LED-48/96W / 700 mA - 2700 K	12431.9	105.5 W	70	19
	102-0276	LED-48/96W / 700 mA - 3000 K	12431.9	105.5 W	80	19
	102-0276-70	LED-48/96W / 700 mA - 3000 K	14146.6	105.5 W	70	19
	102-0277	LED-48/96W / 700 mA - 4000 K	13289.2	105.5 W	80	19
	102-0277-70	LED-48/96W / 700 mA - 4000 K	15004	105.5 W	70	19

WE-EF LIGHTING USA, LLC

410-D Keystone Drive, 15086 Warrendale, PA 15086 - Phone: +1 724 742 0030

customersupport.usa@we-ef.com - <https://we-ef.com/us>

Subject to technical changes and errors. - Generated on 11/23/2024

AFL130 LED

Street and Area Lighting



Light distribution	Part ID	Light source	Rated lumens	Rated input power	CRI	Weight (lb)
	102-0932	LED-48/144W / 1050 mA - 2200 K	14657.9	159 W	70	19
	102-0933	LED-48/144W / 1050 mA - 2700 K	14657.9	159 W	80	19
	102-0933-70	LED-48/144W / 1050 mA - 2700 K	18371.3	159 W	70	19
	102-0934	LED-48/144W / 1050 mA - 3000 K	15830.6	159 W	80	19
	102-0934-70	LED-48/144W / 1050 mA - 3000 K	19153	159 W	70	19
	102-0935	LED-48/144W / 1050 mA - 4000 K	16807.8	159 W	80	19
	102-0935-70	LED-48/144W / 1050 mA - 4000 K	19934.8	159 W	70	19

WE-EF LIGHTING USA, LLC

410-D Keystone Drive, 15086 Warrendale, PA 15086 - Phone: +1 724 742 0030
customersupport.usa@we-ef.com - <https://we-ef.com/us>

Subject to technical changes and errors. - Generated on 11/23/2024

Mounting Accessories

Bird deterrent

Description	Part ID
Bird deterrent BD	430-0015

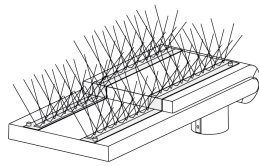

Adaptor

Description	Part ID
Adaptor AFL100	102-0392

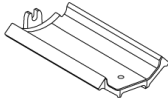

Wall and pole brackets RE

Description	Part ID	C1	D1	D2	D x L1	H1	M1	Weight (lb)
RE2-540 Pole bracket, double	111-0043	7.87			3 x 5	21.65		11.68

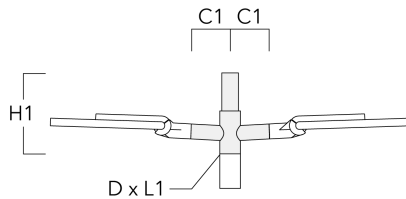

Description	Part ID	C1	D1	D2	D × L1	H1	M1	Weight (lb)
RE0-540 Wall bracket	111-0084	7.09	9.06	7.68			0.47	7.05

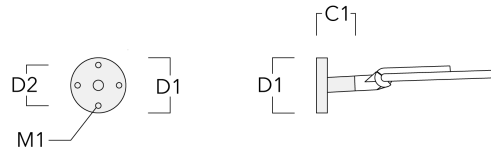

RE1-540 Pole bracket, single	111-0042	200			3 x 5	500		4.60
------------------------------	----------	-----	--	--	-------	-----	--	------

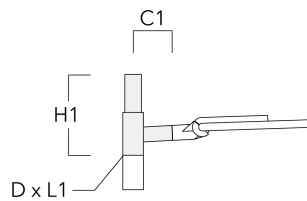

Pole brackets RF

Description	Part ID	C1	D x L1	H1	Weight (lb)
RF2-540 Pole bracket, double	111-0047	7.87	3 x 3	7.87	7.28

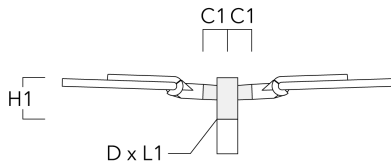

RF1-540 Pole bracket, single	111-0046	200	3 x 3	200	2.60
------------------------------	----------	-----	-------	-----	------

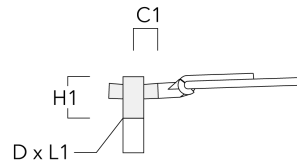

Wall and pole brackets RX

Description	Part ID	C1	D1	D2	D x L1	H1	H2	M1	M2	Weight (lb)
RX1-540 Pole bracket, single	111-0054	39.37			2.99 x 3.15	21.65				14.99

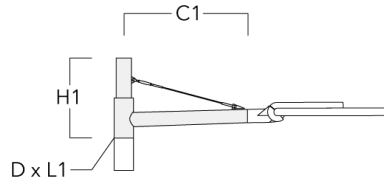

RX2-540 Pole bracket, double	111-0055	39.37			2.99 x 3.15	21.65				21.38
------------------------------	----------	-------	--	--	-------------	-------	--	--	--	-------

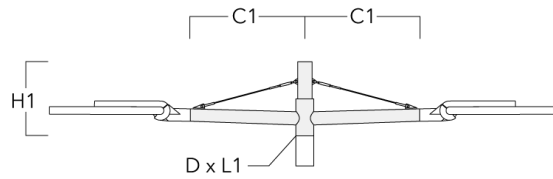

Description	Part ID	C1	D1	D2	D × L1	H1	H2	M1	M2	Weight (lb)
RX0-540 Wall bracket	111-0086	39.37	5.51	3.94		17.72	15.16	1.18	0.47	11.46

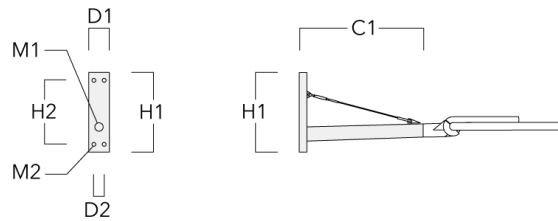

Optical Accessories

Backlight shield

Description	Part ID	Additional information
LS180	430-0029	Glare Shield for backlight spill. Glare Shield factory-installed or available as retrofit kit. Suitable for [S61][S66][R61][P66][Q66][A61] lenses. Must be specified at time of ordering.

