

AFL130 LED

Pole mounted

we-ef

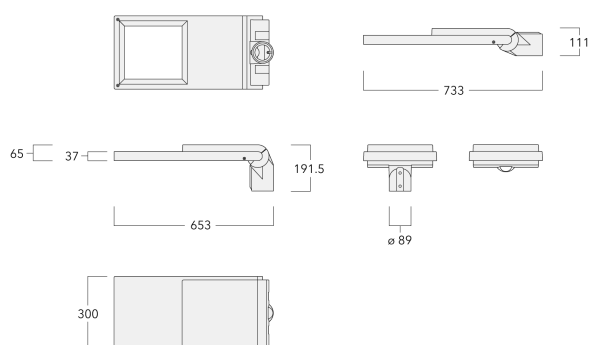
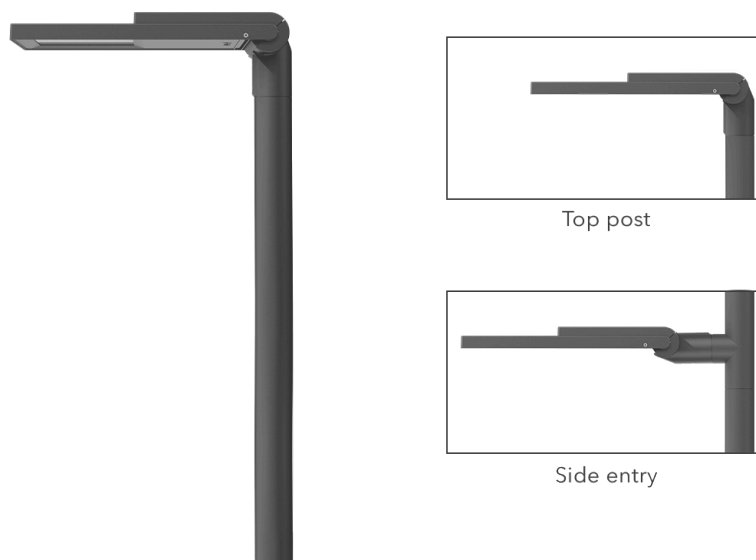

Description

IP66, Class I. IK08. Marine-grade, die-cast aluminium alloy. 5CE superior corrosion protection including PCS hardware. CCG® Controlled Compression Gasket. Non-reflective flat safety glass cover, hinged. Luminaire is factory-sealed and does not need to be opened during installation.

Integral EC electronic converter. DALI interface. CAD-optimised optics for superior illumination and glare control. OLC® One LED Concept.

Suitable for using as post top or side entry version. Recommend to be specified at time of ordering.

Optional spigot adaptor Ø 60 x 100 mm or 42 x 100 mm available; refer to accessory listings.





WE-EF LIGHTING (Thailand) Co., Ltd.

57 Moo 5, Kingkaew Rd., Bangplee, 10540 Samutprakarn - Phone: +66 2 738 96 20 - Fax: +66 2 738 96 29

<https://we-ef.com/asia>

Subject to technical changes and errors. - Generated on 23/11/2024

Specifications**Material description**

Body	Marine-grade, die-cast aluminium alloy
Lens	Non-reflective safety glass lens
Colours	 RAL9004 Signal black  RAL9007 Grey aluminium  RAL7016 Anthracite grey  RAL9016 Traffic white
Gasket	CCG® Controlled Compression Gasket
Fasteners	PCS Polymer Coated Stainless Steel Hardware
Ingress protection	IP66
Impact resistance	IK08
Corrosion resistance	5CE
Windage	0.1956 m ²

Electrical description

Driver / Ballast	Integral electronic converter with DALI interface
Power factor	> 0.9
Surge protection	6/6kV, optional 10kV

Additional information

Lifetime	Ta=25° L90B10 > 90000h
----------	------------------------

AFL130 LED

Pole mounted

we-ef

Options

Light distribution



asymmetric, side throw [S61]



asymmetric, side throw [S65]



rectangular, side throw [R60]



pedestrian/bicycle lane [P66]



asymmetric, forward throw [A61]



square distribution [Q66]



pedestrian crossing, right-hand traffic [P46R]



pedestrian crossing, left-hand traffic [P46L]



asymmetric, side throw [S66]



asymmetric, side throw [S71]



rectangular, side throw [R61]

Colour temperature



2200 K



2700 K



3000 K



4000 K

Nominal Watt

24 W

Configurations

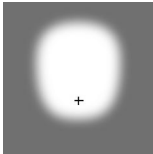
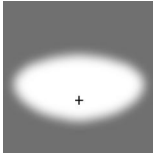
Light distribution	Part ID	Light source	Rated lumens	Rated input power	CRI	Weight (kg)
asymmetric, forward throw [A61] 	102-0179	LED-48/48W / 350 mA - 2200 K	6099.6	52 W	70	8.6
	102-0180	LED-48/48W / 350 mA - 2700 K	6099.6	52 W	80	8.6
	102-0180-70	LED-48/48W / 350 mA - 2700 K	6520.3	52 W	70	8.6
	102-0181	LED-48/48W / 350 mA - 3000 K	6520.3	52 W	80	8.6
	102-0181-70	LED-48/48W / 350 mA - 3000 K	7572	52 W	70	8.6
	102-0182	LED-48/48W / 350 mA - 4000 K	7151.3	52 W	80	8.6
	102-0182-70	LED-48/48W / 350 mA - 4000 K	7992.6	52 W	70	8.6
	102-0224	LED-48/72W / 500 mA - 2200 K	8750.8	77 W	70	8.6
	102-0225	LED-48/72W / 500 mA - 2700 K	8750.8	77 W	80	8.6
	102-0225-70	LED-48/72W / 500 mA - 2700 K	9407.1	77 W	70	8.6
	102-0226	LED-48/72W / 500 mA - 3000 K	9407.1	77 W	80	8.6
	102-0226-70	LED-48/72W / 500 mA - 3000 K	10719.7	77 W	70	8.6
	102-0227	LED-48/72W / 500 mA - 4000 K	10063.4	77 W	80	8.6
	102-0227-70	LED-48/72W / 500 mA - 4000 K	11376	77 W	70	8.6
	102-0269	LED-48/96W / 700 mA - 2200 K	11813.6	105.5 W	70	8.6
	102-0270	LED-48/96W / 700 mA - 2700 K	11813.6	105.5 W	80	8.6
	102-0270-70	LED-48/96W / 700 mA - 2700 K	12688.6	105.5 W	70	8.6
	102-0271	LED-48/96W / 700 mA - 3000 K	12688.6	105.5 W	80	8.6
	102-0271-70	LED-48/96W / 700 mA - 3000 K	14438.8	105.5 W	70	8.6
	102-0272	LED-48/96W / 700 mA - 4000 K	13563.7	105.5 W	80	8.6
	102-0272-70	LED-48/96W / 700 mA - 4000 K	15313.9	105.5 W	70	8.6
	102-0928	LED-48/144W / 1050 mA - 2200 K	14423.1	159 W	70	8.6
	102-0929	LED-48/144W / 1050 mA - 2700 K	14423.1	159 W	80	8.6
	102-0929-70	LED-48/144W / 1050 mA - 2700 K	18077	159 W	70	8.6
	102-0930	LED-48/144W / 1050 mA - 3000 K	15577	159 W	80	8.6
	102-0930-70	LED-48/144W / 1050 mA - 3000 K	18846.2	159 W	70	8.6
	102-0931	LED-48/144W / 1050 mA - 4000 K	16538.5	159 W	80	8.6
102-0931-70	LED-48/144W / 1050 mA - 4000 K	19615.5	159 W	70	8.6	
asymmetric, side throw [S61] 	102-0154	LED-48/48W / 350 mA - 2200 K	6594.1	52 W	70	8.6
	102-0155	LED-48/48W / 350 mA - 2700 K	6594.1	52 W	80	8.6
	102-0155-70	LED-48/48W / 350 mA - 2700 K	7048.9	52 W	70	8.6
	102-0156	LED-48/48W / 350 mA - 3000 K	7048.9	52 W	80	8.6
	102-0156-70	LED-48/48W / 350 mA - 3000 K	8185.8	52 W	70	8.6
	102-0157	LED-48/48W / 350 mA - 4000 K	7731	52 W	80	8.6
	102-0157-70	LED-48/48W / 350 mA - 4000 K	8640.6	52 W	70	8.6

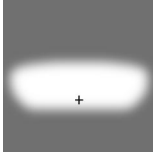
Light distribution	Part ID	Light source	Rated lumens	Rated input power	CRI	Weight (kg)
	102-0199	LED-48/72W / 500 mA - 2200 K	8974.4	77 W	70	8.6
	102-0200	LED-48/72W / 500 mA - 2700 K	8974.4	77 W	80	8.6
	102-0200-70	LED-48/72W / 500 mA - 2700 K	9647.5	77 W	70	8.6
	102-0201	LED-48/72W / 500 mA - 3000 K	9647.5	77 W	80	8.6
	102-0201-70	LED-48/72W / 500 mA - 3000 K	10993.7	77 W	70	8.6
	102-0202	LED-48/72W / 500 mA - 4000 K	10320.6	77 W	80	8.6
	102-0202-70	LED-48/72W / 500 mA - 4000 K	11666.8	77 W	70	8.6
	102-0244	LED-48/96W / 700 mA - 2200 K	12115.5	105.5 W	70	8.6
	102-0245	LED-48/96W / 700 mA - 2700 K	12115.5	105.5 W	80	8.6
	102-0245-70	LED-48/96W / 700 mA - 2700 K	13012.9	105.5 W	70	8.6
	102-0246	LED-48/96W / 700 mA - 3000 K	13012.9	105.5 W	80	8.6
	102-0246-70	LED-48/96W / 700 mA - 3000 K	14807.8	105.5 W	70	8.6
	102-0247	LED-48/96W / 700 mA - 4000 K	13910.4	105.5 W	80	8.6
	102-0247-70	LED-48/96W / 700 mA - 4000 K	15705.3	105.5 W	70	8.6
	102-0908	LED-48/144W / 1050 mA - 2200 K	15592.5	159 W	70	8.6
	102-0909	LED-48/144W / 1050 mA - 2700 K	15592.5	159 W	80	8.6
	102-0909-70	LED-48/144W / 1050 mA - 2700 K	19542.6	159 W	70	8.6
	102-0910	LED-48/144W / 1050 mA - 3000 K	16839.9	159 W	80	8.6
	102-0910-70	LED-48/144W / 1050 mA - 3000 K	20374.2	159 W	70	8.6
	102-0911	LED-48/144W / 1050 mA - 4000 K	17879.4	159 W	80	8.6
	102-0911-70	LED-48/144W / 1050 mA - 4000 K	21205.8	159 W	70	8.6
asymmetric, side throw [S65]	102-0159	LED-48/48W / 350 mA - 2200 K	6361.8	52 W	70	8.6
	102-0160	LED-48/48W / 350 mA - 2700 K	6361.8	52 W	80	8.6
	102-0160-70	LED-48/48W / 350 mA - 2700 K	6800.6	52 W	70	8.6
	102-0161	LED-48/48W / 350 mA - 3000 K	6800.6	52 W	80	8.6
	102-0161-70	LED-48/48W / 350 mA - 3000 K	7897.5	52 W	70	8.6
	102-0162	LED-48/48W / 350 mA - 4000 K	7458.7	52 W	80	8.6
	102-0162-70	LED-48/48W / 350 mA - 4000 K	8336.2	52 W	70	8.6
	102-0204	LED-48/72W / 500 mA - 2200 K	8774.9	77 W	70	8.6
	102-0205	LED-48/72W / 500 mA - 2700 K	8774.9	77 W	80	8.6
	102-0205-70	LED-48/72W / 500 mA - 2700 K	9433.1	77 W	70	8.6
	102-0206	LED-48/72W / 500 mA - 3000 K	9433.1	77 W	80	8.6
	102-0206-70	LED-48/72W / 500 mA - 3000 K	10749.3	77 W	70	8.6
	102-0207	LED-48/72W / 500 mA - 4000 K	10091.2	77 W	80	8.6
	102-0207-70	LED-48/72W / 500 mA - 4000 K	11407.4	77 W	70	8.6
	102-0249	LED-48/96W / 700 mA - 2200 K	11846.2	105.5 W	70	8.6

AFL130 LED

Pole mounted

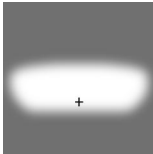
Light distribution	Part ID	Light source	Rated lumens	Rated input power	CRI	Weight (kg)
	102-0250	LED-48/96W / 700 mA - 2700 K	11846.2	105.5 W	80	8.6
	102-0250-70	LED-48/96W / 700 mA - 2700 K	12723.7	105.5 W	70	8.6
	102-0251	LED-48/96W / 700 mA - 3000 K	12723.7	105.5 W	80	8.6
	102-0251-70	LED-48/96W / 700 mA - 3000 K	14478.7	105.5 W	70	8.6
	102-0252	LED-48/96W / 700 mA - 4000 K	13601.2	105.5 W	80	8.6
	102-0252-70	LED-48/96W / 700 mA - 4000 K	15356.2	105.5 W	70	8.6
	102-0912	LED-48/144W / 1050 mA - 2200 K	15795.2	159 W	70	8.6
	102-0913	LED-48/144W / 1050 mA - 2700 K	15795.2	159 W	80	8.6
	102-0913-70	LED-48/144W / 1050 mA - 2700 K	19796.6	159 W	70	8.6
	102-0914	LED-48/144W / 1050 mA - 3000 K	17058.8	159 W	80	8.6
	102-0914-70	LED-48/144W / 1050 mA - 3000 K	20639.1	159 W	70	8.6
	102-0915	LED-48/144W / 1050 mA - 4000 K	18111.8	159 W	80	8.6
	102-0915-70	LED-48/144W / 1050 mA - 4000 K	21481.5	159 W	70	8.6
asymmetric, side throw [S66]	102-0350	LED-48/48W / 350 mA - 2200 K	6528.5	52 W	70	8.6
	102-0351	LED-48/48W / 350 mA - 2700 K	6528.5	52 W	80	8.6
	102-0351-70	LED-48/48W / 350 mA - 2700 K	6978.7	52 W	70	8.6
	102-0352	LED-48/48W / 350 mA - 3000 K	6978.7	52 W	80	8.6
	102-0352-70	LED-48/48W / 350 mA - 3000 K	8104.3	52 W	70	8.6
	102-0353	LED-48/48W / 350 mA - 4000 K	7654.1	52 W	80	8.6
	102-0353-70	LED-48/48W / 350 mA - 4000 K	8554.6	52 W	70	8.6
	102-0362	LED-48/72W / 500 mA - 2200 K	8576.2	77 W	70	8.6
	102-0363	LED-48/72W / 500 mA - 2700 K	8576.2	77 W	80	8.6
	102-0363-70	LED-48/72W / 500 mA - 2700 K	9219.4	77 W	70	8.6
	102-0364	LED-48/72W / 500 mA - 3000 K	9219.4	77 W	80	8.6
	102-0364-70	LED-48/72W / 500 mA - 3000 K	10505.9	77 W	70	8.6
	102-0365	LED-48/72W / 500 mA - 4000 K	9862.7	77 W	80	8.6
	102-0365-70	LED-48/72W / 500 mA - 4000 K	11149.1	77 W	70	8.6
	102-0374	LED-48/96W / 700 mA - 2200 K	11577.9	105.5 W	70	8.6
	102-0375	LED-48/96W / 700 mA - 2700 K	11577.9	105.5 W	80	8.6
	102-0375-70	LED-48/96W / 700 mA - 2700 K	12435.5	105.5 W	70	8.6
	102-0376	LED-48/96W / 700 mA - 3000 K	12435.5	105.5 W	80	8.6
	102-0376-70	LED-48/96W / 700 mA - 3000 K	14150.8	105.5 W	70	8.6
	102-0377	LED-48/96W / 700 mA - 4000 K	13293.2	105.5 W	80	8.6
	102-0377-70	LED-48/96W / 700 mA - 4000 K	15008.4	105.5 W	70	8.6
	102-0944	LED-48/144W / 1050 mA - 2200 K	15437.4	159 W	70	8.6
	102-0945	LED-48/144W / 1050 mA - 2700 K	15437.4	159 W	80	8.6

WE-EF LIGHTING (Thailand) Co., Ltd.

57 Moo 5, Kingkaew Rd., Bangplee, 10540 Samutprakarn - Phone: +66 2 738 96 20 - Fax: +66 2 738 96 29

<https://we-ef.com/asia>

Subject to technical changes and errors. - Generated on 23/11/2024

AFL130 LED

Pole mounted

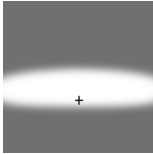
Light distribution	Part ID	Light source	Rated lumens	Rated input power	CRI	Weight (kg)
	102-0945-70	LED-48/144W / 1050 mA - 2700 K	19348.2	159 W	70	8.6
	102-0946	LED-48/144W / 1050 mA - 3000 K	16672.4	159 W	80	8.6
	102-0946-70	LED-48/144W / 1050 mA - 3000 K	20171.5	159 W	70	8.6
	102-0947	LED-48/144W / 1050 mA - 4000 K	17701.5	159 W	80	8.6
	102-0947-70	LED-48/144W / 1050 mA - 4000 K	20994.8	159 W	70	8.6
asymmetric, side throw [S71]	102-0354	LED-48/48W / 350 mA - 2200 K	6025.3	52 W	70	8.6
	102-0355	LED-48/48W / 350 mA - 2700 K	6025.3	52 W	80	8.6
	102-0355-70	LED-48/48W / 350 mA - 2700 K	6440.8	52 W	70	8.6
	102-0356	LED-48/48W / 350 mA - 3000 K	6440.8	52 W	80	8.6
	102-0356-70	LED-48/48W / 350 mA - 3000 K	7479.6	52 W	70	8.6
	102-0357	LED-48/48W / 350 mA - 4000 K	7064.1	52 W	80	8.6
	102-0357-70	LED-48/48W / 350 mA - 4000 K	7895.2	52 W	70	8.6
	102-0366	LED-48/72W / 500 mA - 2200 K	7915.2	77 W	70	8.6
	102-0367	LED-48/72W / 500 mA - 2700 K	7915.2	77 W	80	8.6
	102-0367-70	LED-48/72W / 500 mA - 2700 K	8508.9	77 W	70	8.6
	102-0368	LED-48/72W / 500 mA - 3000 K	8508.9	77 W	80	8.6
	102-0368-70	LED-48/72W / 500 mA - 3000 K	9696.1	77 W	70	8.6
	102-0369	LED-48/72W / 500 mA - 4000 K	9102.5	77 W	80	8.6
	102-0369-70	LED-48/72W / 500 mA - 4000 K	10289.8	77 W	70	8.6
	102-0378	LED-48/96W / 700 mA - 2200 K	10685.5	105.5 W	70	8.6
	102-0379	LED-48/96W / 700 mA - 2700 K	10685.5	105.5 W	80	8.6
	102-0379-70	LED-48/96W / 700 mA - 2700 K	11477.1	105.5 W	70	8.6
	102-0380	LED-48/96W / 700 mA - 3000 K	11477.1	105.5 W	80	8.6
	102-0380-70	LED-48/96W / 700 mA - 3000 K	13060.1	105.5 W	70	8.6
	102-0381	LED-48/96W / 700 mA - 4000 K	12268.6	105.5 W	80	8.6
	102-0381-70	LED-48/96W / 700 mA - 4000 K	13851.6	105.5 W	70	8.6
	102-0948	LED-48/144W / 1050 mA - 2200 K	14247.6	159 W	70	8.6
	102-0949	LED-48/144W / 1050 mA - 2700 K	14247.6	159 W	80	8.6
	102-0949-70	LED-48/144W / 1050 mA - 2700 K	17857	159 W	70	8.6
	102-0950	LED-48/144W / 1050 mA - 3000 K	15387.4	159 W	80	8.6
	102-0950-70	LED-48/144W / 1050 mA - 3000 K	18616.9	159 W	70	8.6
	102-0951	LED-48/144W / 1050 mA - 4000 K	16337.3	159 W	80	8.6
	102-0951-70	LED-48/144W / 1050 mA - 4000 K	19376.8	159 W	70	8.6
pedestrian crossing, left-hand traffic [P46L]	102-0194	LED-48/48W / 350 mA - 2200 K	6704.2	52 W	70	8.6
	102-0195	LED-48/48W / 350 mA - 2700 K	6704.2	52 W	80	8.6
	102-0195-70	LED-48/48W / 350 mA - 2700 K	7166.5	52 W	70	8.6

WE-EF LIGHTING (Thailand) Co., Ltd.

57 Moo 5, Kingkaew Rd., Bangplee, 10540 Samutprakarn - Phone: +66 2 738 96 20 - Fax: +66 2 738 96 29

<https://we-ef.com/asia>

Subject to technical changes and errors. - Generated on 23/11/2024

Light distribution	Part ID	Light source	Rated lumens	Rated input power	CRI	Weight (kg)
	102-0196	LED-48/48W / 350 mA - 3000 K	7166.5	52 W	80	8.6
	102-0196-70	LED-48/48W / 350 mA - 3000 K	8322.4	52 W	70	8.6
	102-0197	LED-48/48W / 350 mA - 4000 K	7860	52 W	80	8.6
	102-0197-70	LED-48/48W / 350 mA - 4000 K	8784.8	52 W	70	8.6
	102-0239	LED-48/72W / 500 mA - 2200 K	9145.3	77 W	70	8.6
	102-0240	LED-48/72W / 500 mA - 2700 K	9145.3	77 W	80	8.6
	102-0240-70	LED-48/72W / 500 mA - 2700 K	9831.2	77 W	70	8.6
	102-0241	LED-48/72W / 500 mA - 3000 K	9831.2	77 W	80	8.6
	102-0241-70	LED-48/72W / 500 mA - 3000 K	11203	77 W	70	8.6
	102-0242	LED-48/72W / 500 mA - 4000 K	10517.1	77 W	80	8.6
	102-0242-70	LED-48/72W / 500 mA - 4000 K	11888.9	77 W	70	8.6
	102-0284	LED-48/96W / 700 mA - 2200 K	12346.2	105.5 W	70	8.6
	102-0285	LED-48/96W / 700 mA - 2700 K	12346.2	105.5 W	80	8.6
	102-0285-70	LED-48/96W / 700 mA - 2700 K	13260.7	105.5 W	70	8.6
	102-0286	LED-48/96W / 700 mA - 3000 K	13260.7	105.5 W	80	8.6
	102-0286-70	LED-48/96W / 700 mA - 3000 K	15089.8	105.5 W	80	8.6
	102-0287	LED-48/96W / 700 mA - 4000 K	14175.3	105.5 W	80	8.6
	102-0287-70	LED-48/96W / 700 mA - 4000 K	16004.3	105.5 W	70	8.6
	102-0940	LED-48/144W / 1050 mA - 2200 K	15852.7	159 W	70	8.6
	102-0941	LED-48/144W / 1050 mA - 2700 K	15852.7	159 W	80	8.6
102-0941-70	LED-48/144W / 1050 mA - 2700 K	19868.7	159 W	70	8.6	
102-0942	LED-48/144W / 1050 mA - 3000 K	17120.9	159 W	80	8.6	
102-0942-70	LED-48/144W / 1050 mA - 3000 K	20714.2	159 W	70	8.6	
102-0943	LED-48/144W / 1050 mA - 4000 K	18177.8	159 W	80	8.6	
102-0943-70	LED-48/144W / 1050 mA - 4000 K	21559.7	159 W	70	8.6	
pedestrian crossing, right-hand traffic [P46R]	102-0189	LED-48/48W / 350 mA - 2200 K	6640.5	52 W	70	8.6
	102-0190	LED-48/48W / 350 mA - 2700 K	6640.5	52 W	80	8.6
	102-0190-70	LED-48/48W / 350 mA - 2700 K	7098.4	52 W	70	8.6
	102-0191	LED-48/48W / 350 mA - 3000 K	7098.4	52 W	80	8.6
	102-0191-70	LED-48/48W / 350 mA - 3000 K	8243.3	52 W	70	8.6
	102-0192	LED-48/48W / 350 mA - 4000 K	7785.4	52 W	80	8.6
	102-0192-70	LED-48/48W / 350 mA - 4000 K	8701.3	52 W	70	8.6
	102-0234	LED-48/72W / 500 mA - 2200 K	9016.9	77 W	70	8.6
	102-0235	LED-48/72W / 500 mA - 2700 K	9016.9	77 W	80	8.6
	102-0235-70	LED-48/72W / 500 mA - 2700 K	9693.2	77 W	70	8.6
102-0236	LED-48/72W / 500 mA - 3000 K	9693.2	77 W	80	8.6	

Light distribution	Part ID	Light source	Rated lumens	Rated input power	CRI	Weight (kg)
	102-0236-70	LED-48/72W / 500 mA - 3000 K	11045.8	77 W	70	8.6
	102-0237	LED-48/72W / 500 mA - 4000 K	10369.5	77 W	80	8.6
	102-0237-70	LED-48/72W / 500 mA - 4000 K	11722	77 W	70	8.6
	102-0279	LED-48/96W / 700 mA - 2200 K	12172.9	105.5 W	70	8.6
	102-0280	LED-48/96W / 700 mA - 2700 K	12172.9	105.5 W	80	8.6
	102-0280-70	LED-48/96W / 700 mA - 2700 K	13074.6	105.5 W	70	8.6
	102-0281	LED-48/96W / 700 mA - 3000 K	13074.6	105.5 W	80	8.6
	102-0281-70	LED-48/96W / 700 mA - 3000 K	14878	105.5 W	70	8.6
	102-0282	LED-48/96W / 700 mA - 4000 K	13976.3	105.5 W	80	8.6
	102-0282-70	LED-48/96W / 700 mA - 4000 K	15779.7	105.5 W	70	8.6
	102-0936	LED-48/144W / 1050 mA - 2200 K	15702	159 W	70	8.6
	102-0937	LED-48/144W / 1050 mA - 2700 K	15702	159 W	80	8.6
	102-0937-70	LED-48/144W / 1050 mA - 2700 K	19679.8	159 W	70	8.6
	102-0938	LED-48/144W / 1050 mA - 3000 K	16958.1	159 W	80	8.6
	102-0938-70	LED-48/144W / 1050 mA - 3000 K	20517.2	159 W	70	8.6
	102-0939	LED-48/144W / 1050 mA - 4000 K	18004.9	159 W	80	8.6
	102-0939-70	LED-48/144W / 1050 mA - 4000 K	21354.7	159 W	70	8.6
pedestrian/bicycle lane [P66]	102-0174	LED-48/48W / 350 mA - 2200 K	6167.1	52 W	70	8.6
	102-0175	LED-48/48W / 350 mA - 2700 K	6167.1	52 W	80	8.6
	102-0175-70	LED-48/48W / 350 mA - 2700 K	6592.4	52 W	70	8.6
	102-0176	LED-48/48W / 350 mA - 3000 K	6592.4	52 W	80	8.6
	102-0176-70	LED-48/48W / 350 mA - 3000 K	7655.7	52 W	70	8.6
	102-0177	LED-48/48W / 350 mA - 4000 K	7230.4	52 W	80	8.6
	102-0177-70	LED-48/48W / 350 mA - 4000 K	8081	52 W	70	8.6
	102-0219	LED-48/72W / 500 mA - 2200 K	8459.9	77 W	70	8.6
	102-0220	LED-48/72W / 500 mA - 2700 K	8459.9	77 W	80	8.6
	102-0220-70	LED-48/72W / 500 mA - 2700 K	9094.4	77 W	70	8.6
	102-0221	LED-48/72W / 500 mA - 3000 K	9094.4	77 W	80	8.6
	102-0221-70	LED-48/72W / 500 mA - 3000 K	10363.4	77 W	70	8.6
	102-0222	LED-48/72W / 500 mA - 4000 K	9728.9	77 W	80	8.6
	102-0222-70	LED-48/72W / 500 mA - 4000 K	10997.9	77 W	70	8.6
	102-0264	LED-48/96W / 700 mA - 2200 K	11420.9	105.5 W	70	8.6
	102-0265	LED-48/96W / 700 mA - 2700 K	11420.9	105.5 W	80	8.6
	102-0265-70	LED-48/96W / 700 mA - 2700 K	12266.9	105.5 W	70	8.6
	102-0266	LED-48/96W / 700 mA - 3000 K	12266.9	105.5 W	80	8.6
	102-0266-70	LED-48/96W / 700 mA - 3000 K	13958.9	105.5 W	70	8.6

pedestrian/bicycle lane [P66]

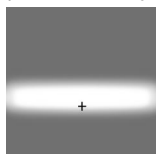

AFL130 LED

Pole mounted

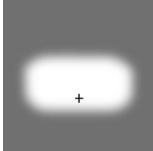
Light distribution	Part ID	Light source	Rated lumens	Rated input power	CRI	Weight (kg)
	102-0267	LED-48/96W / 700 mA - 4000 K	13112.9	105.5 W	80	8.6
	102-0267-70	LED-48/96W / 700 mA - 4000 K	14804.8	105.5 W	70	8.6
	102-0924	LED-48/144W / 1050 mA - 2200 K	14582.9	159 W	70	8.6
	102-0925	LED-48/144W / 1050 mA - 2700 K	14582.9	159 W	80	8.6
	102-0925-70	LED-48/144W / 1050 mA - 2700 K	18277.2	159 W	70	8.6
	102-0926	LED-48/144W / 1050 mA - 3000 K	15749.5	159 W	80	8.6
	102-0926-70	LED-48/144W / 1050 mA - 3000 K	19054.9	159 W	70	8.6
	102-0927	LED-48/144W / 1050 mA - 4000 K	16721.7	159 W	80	8.6
	102-0927-70	LED-48/144W / 1050 mA - 4000 K	19832.7	159 W	70	8.6
rectangular, side throw [R60]	102-0169	LED-48/48W / 350 mA - 2200 K	6081.9	52 W	70	8.6
	102-0170	LED-48/48W / 350 mA - 2700 K	6081.9	52 W	80	8.6
	102-0170-70	LED-48/48W / 350 mA - 2700 K	6501.4	52 W	70	8.6
	102-0171	LED-48/48W / 350 mA - 3000 K	6501.4	52 W	80	8.6
	102-0171-70	LED-48/48W / 350 mA - 3000 K	7550	52 W	70	8.6
	102-0172	LED-48/48W / 350 mA - 4000 K	7130.5	52 W	80	8.6
	102-0172-70	LED-48/48W / 350 mA - 4000 K	7969.4	52 W	70	8.6
	102-0214	LED-48/72W / 500 mA - 2200 K	8751.4	77 W	70	8.6
	102-0215	LED-48/72W / 500 mA - 2700 K	8751.4	77 W	80	8.6
	102-0215-70	LED-48/72W / 500 mA - 2700 K	9407.8	77 W	70	8.6
	102-0216	LED-48/72W / 500 mA - 3000 K	9407.8	77 W	80	8.6
	102-0216-70	LED-48/72W / 500 mA - 3000 K	10720.5	77 W	70	8.6
	102-0217	LED-48/72W / 500 mA - 4000 K	10064.2	77 W	80	8.6
	102-0217-70	LED-48/72W / 500 mA - 4000 K	11376.9	77 W	70	8.6
	102-0259	LED-48/96W / 700 mA - 2200 K	11814.4	105.5 W	70	8.6
	102-0260	LED-48/96W / 700 mA - 2700 K	11814.4	105.5 W	80	8.6
	102-0260-70	LED-48/96W / 700 mA - 2700 K	12689.6	105.5 W	70	8.6
	102-0261	LED-48/96W / 700 mA - 3000 K	12689.6	105.5 W	80	8.6
	102-0261-70	LED-48/96W / 700 mA - 3000 K	14439.9	105.5 W	70	8.6
	102-0262	LED-48/96W / 700 mA - 4000 K	13564.7	105.5 W	80	8.6
	102-0262-70	LED-48/96W / 700 mA - 4000 K	15315	105.5 W	70	8.6
	102-0920	LED-48/144W / 1050 mA - 2200 K	14519.4	159 W	70	8.6
	102-0921	LED-48/144W / 1050 mA - 2700 K	14519.4	159 W	80	8.6
	102-0921-70	LED-48/144W / 1050 mA - 2700 K	18197.6	159 W	70	8.6
	102-0922	LED-48/144W / 1050 mA - 3000 K	15680.9	159 W	80	8.6
	102-0922-70	LED-48/144W / 1050 mA - 3000 K	18972	159 W	70	8.6
	102-0923	LED-48/144W / 1050 mA - 4000 K	16648.9	159 W	80	8.6

WE-EF LIGHTING (Thailand) Co., Ltd.

57 Moo 5, Kingkaew Rd., Bangplee, 10540 Samutprakarn - Phone: +66 2 738 96 20 - Fax: +66 2 738 96 29

<https://we-ef.com/asia>

Subject to technical changes and errors. - Generated on 23/11/2024

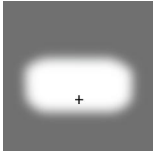
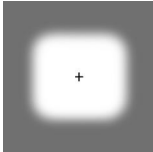
Light distribution	Part ID	Light source	Rated lumens	Rated input power	CRI	Weight (kg)
rectangular, side throw [R61] 	102-0923-70	LED-48/144W / 1050 mA - 4000 K	19746.3	159 W	70	8.6
	102-0358	LED-48/48W / 350 mA - 2200 K	6039.9	52 W	70	8.6
	102-0359	LED-48/48W / 350 mA - 2700 K	6039.9	52 W	80	8.6
	102-0359-70	LED-48/48W / 350 mA - 2700 K	6456.5	52 W	70	8.6
	102-0360	LED-48/48W / 350 mA - 3000 K	6456.5	52 W	80	8.6
	102-0360-70	LED-48/48W / 350 mA - 3000 K	7497.9	52 W	70	8.6
	102-0361	LED-48/48W / 350 mA - 4000 K	7081.3	52 W	80	8.6
	102-0361-70	LED-48/48W / 350 mA - 4000 K	7914.4	52 W	70	8.6
	102-0370	LED-48/72W / 500 mA - 2200 K	7934.4	77 W	70	8.6
	102-0371	LED-48/72W / 500 mA - 2700 K	7934.4	77 W	80	8.6
	102-0371-70	LED-48/72W / 500 mA - 2700 K	8529.5	77 W	70	8.6
	102-0372	LED-48/72W / 500 mA - 3000 K	8529.5	77 W	80	8.6
	102-0372-70	LED-48/72W / 500 mA - 3000 K	9719.6	77 W	70	8.6
	102-0373	LED-48/72W / 500 mA - 4000 K	9124.5	77 W	80	8.6
	102-0373-70	LED-48/72W / 500 mA - 4000 K	10314.7	77 W	70	8.6
	102-0382	LED-48/96W / 700 mA - 2200 K	10711.4	105.5 W	70	8.6
	102-0383	LED-48/96W / 700 mA - 2700 K	10711.4	105.5 W	80	8.6
	102-0383-70	LED-48/96W / 700 mA - 2700 K	11504.9	105.5 W	70	8.6
	102-0384	LED-48/96W / 700 mA - 3000 K	11504.9	105.5 W	80	8.6
	102-0384-70	LED-48/96W / 700 mA - 3000 K	13091.7	105.5 W	70	8.6
	102-0385	LED-48/96W / 700 mA - 4000 K	12298.3	105.5 W	80	8.6
	102-0385-70	LED-48/96W / 700 mA - 4000 K	13885.2	105.5 W	70	8.6
	102-0952	LED-48/144W / 1050 mA - 2200 K	14282.1	159 W	70	8.6
	102-0953	LED-48/144W / 1050 mA - 2700 K	14282.1	159 W	80	8.6
	102-0953-70	LED-48/144W / 1050 mA - 2700 K	17900.2	159 W	70	8.6
	102-0954	LED-48/144W / 1050 mA - 3000 K	15424.7	159 W	80	8.6
	102-0954-70	LED-48/144W / 1050 mA - 3000 K	18661.9	159 W	70	8.6
102-0955	LED-48/144W / 1050 mA - 4000 K	16376.8	159 W	80	8.6	
102-0955-70	LED-48/144W / 1050 mA - 4000 K	19423.7	159 W	70	8.6	
square distribution [Q66] 	102-0184	LED-48/48W / 350 mA - 2200 K	6198.8	52 W	70	8.6
	102-0185	LED-48/48W / 350 mA - 2700 K	6198.8	52 W	80	8.6
	102-0185-70	LED-48/48W / 350 mA - 2700 K	6626.3	52 W	70	8.6
	102-0186	LED-48/48W / 350 mA - 3000 K	6626.3	52 W	80	8.6
	102-0186-70	LED-48/48W / 350 mA - 3000 K	7695.1	52 W	70	8.6
	102-0187	LED-48/48W / 350 mA - 4000 K	7267.6	52 W	80	8.6
	102-0187-70	LED-48/48W / 350 mA - 4000 K	8122.6	52 W	70	8.6

AFL130 LED

Pole mounted

Light distribution	Part ID	Light source	Rated lumens	Rated input power	CRI	Weight (kg)
	102-0229	LED-48/72W / 500 mA - 2200 K	8573.7	77 W	70	8.6
	102-0230	LED-48/72W / 500 mA - 2700 K	8573.7	77 W	80	8.6
	102-0230-70	LED-48/72W / 500 mA - 2700 K	9216.7	77 W	70	8.6
	102-0231	LED-48/72W / 500 mA - 3000 K	9216.7	77 W	80	8.6
	102-0231-70	LED-48/72W / 500 mA - 3000 K	10502.8	77 W	70	8.6
	102-0232	LED-48/72W / 500 mA - 4000 K	9859.8	77 W	80	8.6
	102-0232-70	LED-48/72W / 500 mA - 4000 K	11145.8	77 W	70	8.6
	102-0274	LED-48/96W / 700 mA - 2200 K	11574.5	105.5 W	70	8.6
	102-0275	LED-48/96W / 700 mA - 2700 K	11574.5	105.5 W	80	8.6
	102-0275-70	LED-48/96W / 700 mA - 2700 K	12431.9	105.5 W	70	8.6
	102-0276	LED-48/96W / 700 mA - 3000 K	12431.9	105.5 W	80	8.6
	102-0276-70	LED-48/96W / 700 mA - 3000 K	14146.6	105.5 W	70	8.6
	102-0277	LED-48/96W / 700 mA - 4000 K	13289.2	105.5 W	80	8.6
	102-0277-70	LED-48/96W / 700 mA - 4000 K	15004	105.5 W	70	8.6
	102-0932	LED-48/144W / 1050 mA - 2200 K	14657.9	159 W	70	8.6
	102-0933	LED-48/144W / 1050 mA - 2700 K	14657.9	159 W	80	8.6
	102-0933-70	LED-48/144W / 1050 mA - 2700 K	18371.3	159 W	70	8.6
	102-0934	LED-48/144W / 1050 mA - 3000 K	15830.6	159 W	80	8.6
	102-0934-70	LED-48/144W / 1050 mA - 3000 K	19153	159 W	70	8.6
	102-0935	LED-48/144W / 1050 mA - 4000 K	16807.8	159 W	80	8.6
	102-0935-70	LED-48/144W / 1050 mA - 4000 K	19934.8	159 W	70	8.6

AFL130 LED

Pole mounted

we-ef

Control

Eco Step Dim

Description	Part ID
ECO Step Dim® Motion LED	400-0044
Eco Step Dim® Advanced LED	430-0002

R2C Ready to Connect

Description	Part ID
R2C Ready to Connect (top)	430-0019
R2C Ready to Connect (below)	430-0027
R2C Ready to Connect (top and below)	430-0032

WE-EF LIGHTING (Thailand) Co., Ltd.

57 Moo 5, Kingkaew Rd., Bangplee, 10540 Samutprakarn - Phone: +66 2 738 96 20 - Fax: +66 2 738 96 29

<https://we-ef.com/asia>

Subject to technical changes and errors. - Generated on 23/11/2024

Optical Accessories

Backlight shield

Description	Part ID	Additional information
Backlight shield LS180	102-0959-48LED	Glare Shield for backlight spill. Suitable for [S65] [R60] lenses. Glare Shield factory-installed or available as retrofit kit. Must be specified at time of ordering.

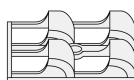

Backlight shield LS180	102-0395-48LED	Glare Shield for backlight spill. Suitable for [S61], [S66], [R61], [P66] [Q66], [A61] lenses. Glare Shield factory-installed or available as retrofit kit. Must be specified at time of ordering.
------------------------	----------------	---

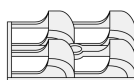

Mounting Accessories**Bird deterrent**

Description	Part ID
Bird deterrent BD	430-0015

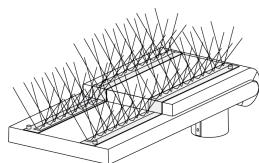

Adaptor

Description	Part ID
Adaptor AFL100	102-0392

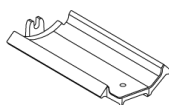

Wall and pole brackets RE

Description	Part ID	C1	D1	D2	D × L1	H1	M1	Weight (kg)
Pole bracket RE2-540, double	111-0043	200			76 x 130	550		5.30

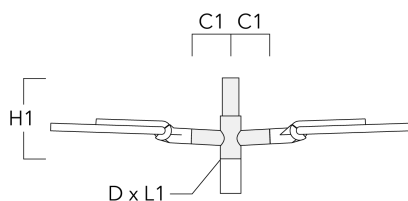

Wall bracket RE0-540	111-0084	180	230	195		12	3.20	
----------------------	----------	-----	-----	-----	--	----	------	--

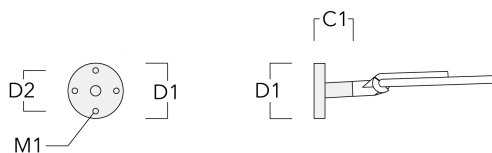

Pole mounted

Description	Part ID	C1	D1	D2	D × L1	H1	M1	Weight (kg)
RE1-540 Pole bracket, single	111-0042	200			76 x 130	500		4.60

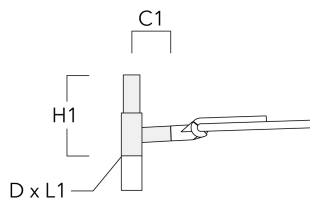

Pole brackets RF

Description	Part ID	C1	D × L1	H1	Weight (kg)
Pole bracket RF2-540, double	111-0047	200	76 x 80	200	3.30

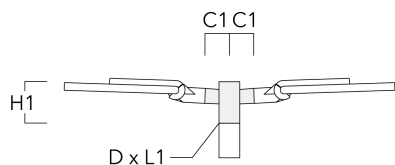

Description	Part ID	C1	D × L1	H1	Weight (kg)
RF1-540 Pole bracket, single	111-0046	200	76 x 80	200	2.60

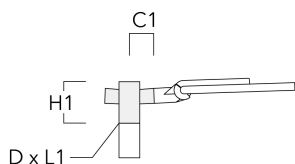

Wall and pole brackets RX

Description	Part ID	C1	D1	D2	D × L1	H1	H2	M1	M2	Weight (kg)
RX1-540 Pole bracket, single	111-0054	1000			76 x 130	550				6.8

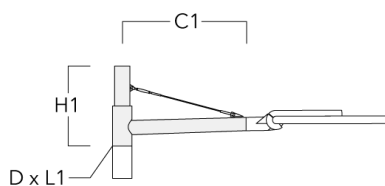

Pole mounted

Description	Part ID	C1	D1	D2	D × L1	H1	H2	M1	M2	Weight (kg)
RX2-540 Pole bracket, double	111-0055	1000			76 x 130	550				9.70

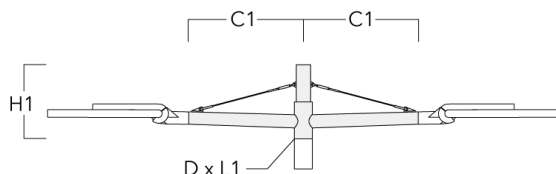

RX0-540 Wall bracket	111-0086	1000	140	100		450	385	30	12	5.20
----------------------	----------	------	-----	-----	--	-----	-----	----	----	------

