

### Description

IP66, Class I or Class II. IK08. Marine-grade, die-cast aluminium alloy. 5CE superior corrosion protection including PCS hardware. CCG® Controlled Compression Gasket. Non-reflective flat safety glass cover, hinged. Integral EC electronic converter. CAD-optimised optics for superior illumination and glare control. OLC® One LED Concept. Factory installed LED circuit board. The luminaire is factory-sealed and does not need to be opened during installation. Can be used as post top or side entry version. Specification at time of order is recommended.

Spigot Ø 3" x 4"





Contact WE-EF direct or your local WE-EF sales representative for an individual solution designed to precisely meet your needs.

**Street and Area Lighting**

---

**Specifications****Material description**

---

Body	Marine-grade, die-cast aluminium alloy
Lens	Non-reflective safety glass lens
Colors	 RAL9004 Black  RAL9007 Grey Metallic  RAL9016 White  RAL8019 Dark Bronze
Gasket	CCG® Controlled Compression Gasket
Fasteners	PCS Polymer Coated Stainless Steel Hardware
Ingress protection	IP66
Impact resistance	IK08
Corrosion resistance	5CE
Windage	0.99 ft <sup>2</sup>

---

**Electrical description**

---

Power supply	120V - 277V Universal Driver
Driver / Ballast	Integral EC electronic converter. 0-10V
Power factor	> 0.9
Surge protection	In-line bracket 10kV Surge Protector

---

**Additional information**

---

Lifetime	Ta=25°/40° L90B10 > 100000h
----------	-----------------------------

---

**Options**

**Light distribution**

**Color temperature**

**Nominal Watt**



[S61] Type III Short



[S65] Type III Medium



[S70] Type II Short



rectangular, side throw [R60]



[P66] Type II Medium



[A61] Type IV Very Short



square distribution [Q66]



pedestrian crossing, right-hand traffic [P46R]



pedestrian crossing, left-hand traffic [P46L]



asymmetric, side throw beam [S66]



asymmetric, side throw [S71]



rectangular, side throw [R61]



2200 K



2700 K



3000 K

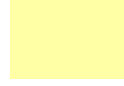

4000 K

8 W

16 W

12 W

24 W

32 W

48 W

## Street and Area Lighting

## Configurations

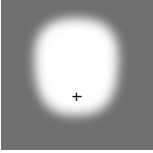
Light distribution	Part ID	Light source	Delivered lumens	Rated input power	CRI	Weight (lb)
[A61] Type IV Very Short 	102-0442	LED-8/8W / 350 mA - 2200K	1005.6	9.5 W	70	10.40
	102-0443	LED-8/8W / 350 mA - 2700K	1005.6	9.5 W	80	10.40
	102-0443-70	LED-8/8W / 350 mA - 2700K	1075	9.5 W	70	10.40
	102-0444	LED-8/8W / 350 mA - 3000K	1075	9.5 W	80	10.40
	102-0444-70	LED-8/8W / 350 mA - 3000K	1248.3	9.5 W	70	10.40
	102-0445	LED-8/8W / 350 mA - 4000K	1179	9.5 W	80	10.40
	102-0445-70	LED-8/8W / 350 mA - 4000K	1317.7	9.5 W	70	10.40
	102-0490	LED-16/16W / 350 mA - 2200K	1947.1	18 W	70	10.40
	102-0491	LED-16/16W / 350 mA - 2700K	1947.1	18 W	80	10.40
	102-0491-70	LED-16/16W / 350 mA - 2700K	2081.4	18 W	70	10.40
	102-0492	LED-16/16W / 350 mA - 3000K	2081.4	18 W	80	10.40
	102-0492-70	LED-16/16W / 350 mA - 3000K	2417.1	18 W	70	10.40
	102-0493	LED-16/16W / 350 mA - 4000K	2282.8	18 W	80	10.40
	102-0493-70	LED-16/16W / 350 mA - 4000K	2551.4	18 W	70	10.40
	102-0538	LED-8/12W / 500 mA - 2200K	1387.1	13.5 W	70	10.40
	102-0539	LED-8/12W / 500 mA - 2700K	1387.1	13.5 W	80	10.40
	102-0539-70	LED-8/12W / 500 mA - 2700K	1491.1	13.5 W	70	10.40
	102-0540	LED-8/12W / 500 mA - 3000K	1491.1	13.5 W	80	10.40
	102-0540-70	LED-8/12W / 500 mA - 3000K	1699.1	13.5 W	70	10.40
	102-0541	LED-8/12W / 500 mA - 4000K	1595.1	13.5 W	80	10.40
	102-0541-70	LED-8/12W / 500 mA - 4000K	1803.2	13.5 W	70	10.40
	102-0586	LED-16/24W / 500 mA - 2200K	2685.7	26 W	70	10.40
	102-0587	LED-16/24W / 500 mA - 2700K	2685.7	26 W	80	10.40
	102-0587-70	LED-16/24W / 500 mA - 2700K	2887.1	26 W	70	10.40
	102-0588	LED-16/24W / 500 mA - 3000K	2887.1	26 W	80	10.40
	102-0588-70	LED-16/24W / 500 mA - 3000K	3290	26 W	70	10.40
	102-0589	LED-16/24W / 500 mA - 4000K	3088.5	26 W	80	10.40
	102-0589-70	LED-16/24W / 500 mA - 4000K	3491.4	26 W	70	10.40
	102-0634	LED-8/16W / 700 mA - 2200K	1783.4	18 W	70	10.40
	102-0635	LED-8/16W / 700 mA - 2700K	1783.4	18 W	80	10.40
	102-0635-70	LED-8/16W / 700 mA - 2700K	1915.5	18 W	70	10.40
	102-0636	LED-8/16W / 700 mA - 3000K	1915.5	18 W	80	10.40

## WE-EF LIGHTING USA, LLC

410-D Keystone Drive, 15086 Warrendale, PA 15086 - Phone: +1 724 742 0030

customersupport.usa@we-ef.com - <https://we-ef.com/us>

Subject to technical changes and errors. - Generated on 03/15/2026

**Street and Area Lighting**

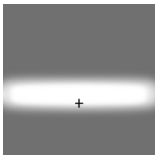
Light distribution	Part ID	Light source	Delivered lumens	Rated input power	CRI	Weight (lb)
	102-0636-70	LED-8/16W / 700 mA - 3000K	2179.7	18 W	70	10.40
	102-0637	LED-8/16W / 700 mA - 4000K	2047.6	18 W	80	10.40
	102-0637-70	LED-8/16W / 700 mA - 4000K	2311.8	18 W	70	10.40
	102-0682	LED-16/32W / 700 mA - 2200K	3453.1	35 W	70	10.40
	102-0683	LED-16/32W / 700 mA - 2700K	3453.1	35 W	80	10.40
	102-0683-70	LED-16/32W / 700 mA - 2700K	3708.9	35 W	70	10.40
	102-0684	LED-16/32W / 700 mA - 3000K	3708.9	35 W	80	10.40
	102-0684-70	LED-16/32W / 700 mA - 3000K	4220.5	35 W	70	10.40
	102-0685	LED-16/32W / 700 mA - 4000K	3964.7	35 W	80	10.40
	102-0685-70	LED-16/32W / 700 mA - 4000K	4476.3	35 W	70	10.40
	102-0730	LED-8/24W / 1050 mA - 2200K	2476.9	27.5 W	70	10.40
	102-0731	LED-8/24W / 1050 mA - 2700K	2476.9	27.5 W	80	10.40
	102-0731-70	LED-8/24W / 1050 mA - 2700K	2675.1	27.5 W	70	10.40
	102-0732	LED-8/24W / 1050 mA - 3000K	2675.1	27.5 W	80	10.40
	102-0732-70	LED-8/24W / 1050 mA - 3000K	3038.4	27.5 W	70	10.40
	102-0733	LED-8/24W / 1050 mA - 4000K	2840.2	27.5 W	80	10.40
	102-0733-70	LED-8/24W / 1050 mA - 4000K	3236.5	27.5 W	70	10.40
	102-0778	LED-16/48W / 1050 mA - 2200K	4796	54 W	70	15.40
	102-0779	LED-16/48W / 1050 mA - 2700K	4796	54 W	80	15.40
	102-0779-70	LED-16/48W / 1050 mA - 2700K	5179.7	54 W	70	15.40
	102-0780	LED-16/48W / 1050 mA - 3000K	5179.7	54 W	80	15.40
	102-0780-70	LED-16/48W / 1050 mA - 3000K	5883.1	54 W	70	15.40
	102-0781	LED-16/48W / 1050 mA - 4000K	5499.4	54 W	80	15.40
	102-0781-70	LED-16/48W / 1050 mA - 4000K	6266.8	54 W	70	15.40
[P66] Type II Medium	102-0438	LED-8/8W / 350 mA - 2200K	985.9	9.5 W	70	10.40
	102-0439	LED-8/8W / 350 mA - 2700K	985.9	9.5 W	80	10.40
	102-0439-70	LED-8/8W / 350 mA - 2700K	1053.9	9.5 W	70	10.40
	102-0440	LED-8/8W / 350 mA - 3000K	1053.9	9.5 W	80	10.40
	102-0440-70	LED-8/8W / 350 mA - 3000K	1223.9	9.5 W	70	10.40
	102-0441	LED-8/8W / 350 mA - 4000K	1155.9	9.5 W	80	10.40
	102-0441-70	LED-8/8W / 350 mA - 4000K	1291.9	9.5 W	70	10.40
	102-0486	LED-16/16W / 350 mA - 2200K	1882.3	18 W	70	10.40
	102-0487	LED-16/16W / 350 mA - 2700K	1882.3	18 W	80	10.40

**WE-EF LIGHTING USA, LLC**

410-D Keystone Drive, 15086 Warrendale, PA 15086 - Phone: +1 724 742 0030

customersupport.usa@we-ef.com - <https://we-ef.com/us>

Subject to technical changes and errors. - Generated on 03/15/2026

## Street and Area Lighting

Light distribution	Part ID	Light source	Delivered lumens	Rated input power	CRI	Weight (lb)
	102-0487-70	LED-16/16W / 350 mA - 2700K	2012.1	18 W	70	10.40
	102-0488	LED-16/16W / 350 mA - 3000K	2012.1	18 W	80	10.40
	102-0488-70	LED-16/16W / 350 mA - 3000K	2336.6	18 W	70	10.40
	102-0489	LED-16/16W / 350 mA - 4000K	2206.8	18 W	80	10.40
	102-0489-70	LED-16/16W / 350 mA - 4000K	2466.5	18 W	70	10.40
	102-0534	LED-8/12W / 500 mA - 2200K	1359.9	13.5 W	70	10.40
	102-0535	LED-8/12W / 500 mA - 2700K	1359.9	13.5 W	80	10.40
	102-0535-70	LED-8/12W / 500 mA - 2700K	1461.8	13.5 W	70	10.40
	102-0536	LED-8/12W / 500 mA - 3000K	1461.8	13.5 W	80	10.40
	102-0536-70	LED-8/12W / 500 mA - 3000K	1665.8	13.5 W	70	10.40
	102-0537	LED-8/12W / 500 mA - 4000K	1563.8	13.5 W	80	10.40
	102-0537-70	LED-8/12W / 500 mA - 4000K	1767.8	13.5 W	70	10.40
	102-0582	LED-16/24W / 500 mA - 2200K	2596.3	26 W	70	10.40
	102-0583	LED-16/24W / 500 mA - 2700K	2596.3	26 W	80	10.40
	102-0583-70	LED-16/24W / 500 mA - 2700K	2791	26 W	70	10.40
	102-0584	LED-16/24W / 500 mA - 3000K	2791	26 W	80	10.40
	102-0584-70	LED-16/24W / 500 mA - 3000K	3180.4	26 W	70	10.40
	102-0585	LED-16/24W / 500 mA - 4000K	2985.7	26 W	80	10.40
	102-0585-70	LED-16/24W / 500 mA - 4000K	3375.1	26 W	70	10.40
	102-0630	LED-8/16W / 700 mA - 2200K	1748.4	18 W	70	10.40
	102-0631	LED-8/16W / 700 mA - 2700K	1748.4	18 W	80	10.40
	102-0631-70	LED-8/16W / 700 mA - 2700K	1877.9	18 W	70	10.40
	102-0632	LED-8/16W / 700 mA - 3000K	1877.9	18 W	80	10.40
	102-0632-70	LED-8/16W / 700 mA - 3000K	2137	18 W	70	10.40
	102-0633	LED-8/16W / 700 mA - 4000K	2007.5	18 W	80	10.40
	102-0633-70	LED-8/16W / 700 mA - 4000K	2266.5	18 W	70	10.40
	102-0678	LED-16/32W / 700 mA - 2200K	3338.2	35 W	70	10.40
	102-0679	LED-16/32W / 700 mA - 2700K	3338.2	35 W	80	10.40
	102-0679-70	LED-16/32W / 700 mA - 2700K	3585.4	35 W	70	10.40
	102-0680	LED-16/32W / 700 mA - 3000K	3585.4	35 W	80	10.40
	102-0680-70	LED-16/32W / 700 mA - 3000K	4080	35 W	70	10.40
	102-0681	LED-16/32W / 700 mA - 4000K	3832.7	35 W	80	10.40
	102-0681-70	LED-16/32W / 700 mA - 4000K	4327.3	35 W	70	10.40

## WE-EF LIGHTING USA, LLC

410-D Keystone Drive, 15086 Warrendale, PA 15086 - Phone: +1 724 742 0030

customersupport.usa@we-ef.com - <https://we-ef.com/us>

Subject to technical changes and errors. - Generated on 03/15/2026

**Street and Area Lighting**

Light distribution	Part ID	Light source	Delivered lumens	Rated input power	CRI	Weight (lb)
	102-0726	LED-8/24W / 1050 mA - 2200K	2428.4	27.5 W	70	10.40
	102-0727	LED-8/24W / 1050 mA - 2700K	2428.4	27.5 W	80	10.40
	102-0727-70	LED-8/24W / 1050 mA - 2700K	2622.6	27.5 W	70	10.40
	102-0728	LED-8/24W / 1050 mA - 3000K	2622.6	27.5 W	80	10.40
	102-0728-70	LED-8/24W / 1050 mA - 3000K	2978.8	27.5 W	70	10.40
	102-0729	LED-8/24W / 1050 mA - 4000K	2784.5	27.5 W	80	10.40
	102-0729-70	LED-8/24W / 1050 mA - 4000K	3173.1	27.5 W	70	10.40
	102-0774	LED-16/48W / 1050 mA - 2200K	4636.3	54 W	70	15.40
	102-0775	LED-16/48W / 1050 mA - 2700K	4636.3	54 W	80	15.40
	102-0775-70	LED-16/48W / 1050 mA - 2700K	5007.3	54 W	70	15.40
	102-0776	LED-16/48W / 1050 mA - 3000K	5007.3	54 W	80	15.40
	102-0776-70	LED-16/48W / 1050 mA - 3000K	5687.2	54 W	70	15.40
	102-0777	LED-16/48W / 1050 mA - 4000K	5316.3	54 W	80	15.40
	102-0777-70	LED-16/48W / 1050 mA - 4000K	6058.2	54 W	70	15.40
[S61] Type III Short	102-0422	LED-8/8W / 350 mA - 2200K	1061.8	9.5 W	70	10.40
	102-0423	LED-8/8W / 350 mA - 2700K	1061.8	9.5 W	80	10.40
	102-0423-70	LED-8/8W / 350 mA - 2700K	1135	9.5 W	70	10.40
	102-0424	LED-8/8W / 350 mA - 3000K	1135	9.5 W	80	10.40
	102-0424-70	LED-8/8W / 350 mA - 3000K	1318.1	9.5 W	70	10.40
	102-0425	LED-8/8W / 350 mA - 4000K	1244.9	9.5 W	80	10.40
	102-0425-70	LED-8/8W / 350 mA - 4000K	1391.3	9.5 W	70	10.40
	102-0470	LED-16/16W / 350 mA - 2200K	2037.5	18 W	70	10.40
	102-0471	LED-16/16W / 350 mA - 2700K	2037.5	18 W	80	10.40
	102-0471-70	LED-16/16W / 350 mA - 2700K	2178	18 W	70	15.40
	102-0472	LED-16/16W / 350 mA - 3000K	2178	18 W	80	10.40
	102-0472-70	LED-16/16W / 350 mA - 3000K	2529.3	18 W	70	10.40
	102-0473	LED-16/16W / 350 mA - 4000K	2388.8	18 W	80	10.40
	102-0473-70	LED-16/16W / 350 mA - 4000K	2669.9	18 W	70	10.40
	102-0518	LED-8/12W / 500 mA - 2200K	1464.6	13.5 W	70	10.40
	102-0519	LED-8/12W / 500 mA - 2700K	1464.6	13.5 W	80	15.40
	102-0519-70	LED-8/12W / 500 mA - 2700K	1574.4	13.5 W	70	10.40
	102-0520	LED-8/12W / 500 mA - 3000K	1574.4	13.5 W	80	10.40
	102-0520-70	LED-8/12W / 500 mA - 3000K	1794.1	13.5 W	70	10.40

**WE-EF LIGHTING USA, LLC**

410-D Keystone Drive, 15086 Warrendale, PA 15086 - Phone: +1 724 742 0030

customersupport.usa@we-ef.com - <https://we-ef.com/us>

Subject to technical changes and errors. - Generated on 03/15/2026

## Street and Area Lighting

Light distribution	Part ID	Light source	Delivered lumens	Rated input power	CRI	Weight (lb)
	102-0521	LED-8/12W / 500 mA - 4000K	1684.2	13.5 W	80	10.40
	102-0521-70	LED-8/12W / 500 mA - 4000K	1903.9	13.5 W	70	10.40
	102-0566	LED-16/24W / 500 mA - 2200K	2810.4	26 W	70	10.40
	102-0567	LED-16/24W / 500 mA - 2700K	2810.4	26 W	80	10.40
	102-0567-70	LED-16/24W / 500 mA - 2700K	3021.2	26 W	70	10.40
	102-0568	LED-16/24W / 500 mA - 3000K	3021.2	26 W	80	10.40
	102-0568-70	LED-16/24W / 500 mA - 3000K	3442.7	26 W	70	10.40
	102-0569	LED-16/24W / 500 mA - 4000K	3231.9	26 W	80	10.40
	102-0569-70	LED-16/24W / 500 mA - 4000K	3653.5	26 W	70	10.40
	102-0614	LED-8/16W / 700 mA - 2200K	1883.1	18 W	70	10.40
	102-0615	LED-8/16W / 700 mA - 2700K	1883.1	18 W	80	10.40
	102-0615-70	LED-8/16W / 700 mA - 2700K	2022.5	18 W	70	10.40
	102-0616	LED-8/16W / 700 mA - 3000K	2022.5	18 W	80	10.40
	102-0616-70	LED-8/16W / 700 mA - 3000K	2301.5	18 W	70	10.40
	102-0617	LED-8/16W / 700 mA - 4000K	2162	18 W	80	10.40
	102-0662	LED-16/32W / 700 mA - 2200K	3613.5	35 W	70	10.40
	102-0663	LED-16/32W / 700 mA - 2700K	3613.5	35 W	80	10.40
	102-0663-70	LED-16/32W / 700 mA - 2700K	3881.1	35 W	70	10.40
	102-0664	LED-16/32W / 700 mA - 3000K	3881.1	35 W	80	10.40
	102-0664-70	LED-16/32W / 700 mA - 3000K	4416.5	35 W	70	10.40
	102-0665	LED-16/32W / 700 mA - 4000K	4148.8	35 W	80	10.40
	102-0665-70	LED-16/32W / 700 mA - 4000K	4684.1	35 W	70	10.40
	102-0710	LED-8/24W / 1050 mA - 2200K	2615.4	27.5 W	70	10.40
	102-0711	LED-8/24W / 1050 mA - 2700K	2615.4	27.5 W	80	10.40
	102-0711-70	LED-8/24W / 1050 mA - 2700K	2824.6	27.5 W	70	10.40
	102-0712	LED-8/24W / 1050 mA - 3000K	2824.6	27.5 W	80	10.40
	102-0712-70	LED-8/24W / 1050 mA - 3000K	3208.2	27.5 W	70	10.40
	102-0713	LED-8/24W / 1050 mA - 4000K	2998.9	27.5 W	80	10.40
	102-0713-70	LED-8/24W / 1050 mA - 4000K	3417.4	27.5 W	70	10.40
	102-0758	LED-16/48W / 1050 mA - 2200K	5018.7	54 W	70	10.40
	102-0759	LED-16/48W / 1050 mA - 2700K	5018.7	54 W	80	10.40
	102-0759-70	LED-16/48W / 1050 mA - 2700K	5420.2	54 W	70	10.40
	102-0760	LED-16/48W / 1050 mA - 3000K	5420.2	54 W	80	10.40

## WE-EF LIGHTING USA, LLC

410-D Keystone Drive, 15086 Warrendale, PA 15086 - Phone: +1 724 742 0030

customersupport.usa@we-ef.com - <https://we-ef.com/us>

Subject to technical changes and errors. - Generated on 03/15/2026

**Street and Area Lighting**

Light distribution	Part ID	Light source	Delivered lumens	Rated input power	CRI	Weight (lb)
	102-0760-70	LED-16/48W / 1050 mA - 3000K	6156.3	54 W	70	10.40
	102-0761	LED-16/48W / 1050 mA - 4000K	5754.8	54 W	80	10.40
	102-0761-70	LED-16/48W / 1050 mA - 4000K	6557.8	54 W	70	10.40
[S65] Type III Medium	102-0426	LED-8/8W / 350 mA - 2200K	1078.9	9.5 W	70	10.40
	102-0427	LED-8/8W / 350 mA - 2700K	1078.9	9.5 W	80	10.40
	102-0427-70	LED-8/8W / 350 mA - 2700K	1153.3	9.5 W	70	10.40
	102-0428	LED-8/8W / 350 mA - 3000K	1153.3	9.5 W	80	10.40
	102-0428-70	LED-8/8W / 350 mA - 3000K	1339.4	9.5 W	70	10.40
	102-0429	LED-8/8W / 350 mA - 4000K	1265	9.5 W	80	10.40
	102-0429-70	LED-8/8W / 350 mA - 4000K	1413.8	9.5 W	70	10.40
	102-0474	LED-16/16W / 350 mA - 2200K	2051.3	18 W	70	10.40
	102-0475	LED-16/16W / 350 mA - 2700K	2051.3	18 W	80	10.40
	102-0475-70	LED-16/16W / 350 mA - 2700K	2192.8	18 W	70	10.40
	102-0476	LED-16/16W / 350 mA - 3000K	2192.8	18 W	80	10.40
	102-0476-70	LED-16/16W / 350 mA - 3000K	2546.5	18 W	70	10.40
	102-0477	LED-16/16W / 350 mA - 4000K	2405	18 W	80	10.40
	102-0477-70	LED-16/16W / 350 mA - 4000K	2687.9	18 W	70	10.40
	102-0522	LED-8/12W / 500 mA - 2200K	1488.2	13.5 W	70	10.40
	102-0523	LED-8/12W / 500 mA - 2700K	1488.2	13.5 W	80	10.40
	102-0523-70	LED-8/12W / 500 mA - 2700K	1599.8	13.5 W	70	10.40
	102-0524	LED-8/12W / 500 mA - 3000K	1599.8	13.5 W	80	10.40
	102-0524-70	LED-8/12W / 500 mA - 3000K	1823	13.5 W	70	10.40
	102-0525	LED-8/12W / 500 mA - 4000K	1711.4	13.5 W	80	10.40
	102-0525-70	LED-8/12W / 500 mA - 4000K	1934.6	13.5 W	70	10.40
	102-0570	LED-16/24W / 500 mA - 2200K	2829.4	26 W	70	18.40
	102-0571	LED-16/24W / 500 mA - 2700K	2829.4	26 W	80	10.40
	102-0571-70	LED-16/24W / 500 mA - 2700K	3041.6	26 W	70	10.40
	102-0572	LED-16/24W / 500 mA - 3000K	3041.6	26 W	80	10.40
	102-0572-70	LED-16/24W / 500 mA - 3000K	3466	26 W	70	10.40
	102-0573	LED-16/24W / 500 mA - 4000K	3253.8	26 W	80	10.40
	102-0573-70	LED-16/24W / 500 mA - 4000K	3678.2	26 W	70	10.40
	102-0618	LED-8/16W / 700 mA - 2200K	1913.4	18 W	70	10.40
	102-0619	LED-8/16W / 700 mA - 2700K	1913.4	18 W	80	10.40

**WE-EF LIGHTING USA, LLC**

410-D Keystone Drive, 15086 Warrendale, PA 15086 - Phone: +1 724 742 0030

customersupport.usa@we-ef.com - <https://we-ef.com/us>

Subject to technical changes and errors. - Generated on 03/15/2026

**Street and Area Lighting**

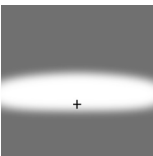
Light distribution	Part ID	Light source	Delivered lumens	Rated input power	CRI	Weight (lb)
	102-0619-70	LED-8/16W / 700 mA - 2700K	2055.2	18 W	70	10.40
	102-0620	LED-8/16W / 700 mA - 3000K	2055.2	18 W	80	10.40
	102-0620-70	LED-8/16W / 700 mA - 3000K	2338.6	18 W	70	10.40
	102-0621	LED-8/16W / 700 mA - 4000K	2196.9	18 W	80	10.40
	102-0621-70	LED-8/16W / 700 mA - 4000K	2480.4	18 W	70	10.40
	102-0666	LED-16/32W / 700 mA - 2200K	3637.9	35 W	70	10.40
	102-0667	LED-16/32W / 700 mA - 2700K	3637.9	35 W	80	10.40
	102-0667-70	LED-16/32W / 700 mA - 2700K	3907.4	35 W	70	10.40
	102-0668	LED-16/32W / 700 mA - 3000K	3907.4	35 W	80	10.40
	102-0668-70	LED-16/32W / 700 mA - 3000K	4446.3	35 W	70	10.40
	102-0669	LED-16/32W / 700 mA - 4000K	4176.8	35 W	80	10.40
	102-0669-70	LED-16/32W / 700 mA - 4000K	4715.8	35 W	70	10.40
	102-0714	LED-8/24W / 1050 mA - 2200K	2657.5	27.5 W	70	10.40
	102-0715	LED-8/24W / 1050 mA - 2700K	2657.5	27.5 W	80	10.40
	102-0715-70	LED-8/24W / 1050 mA - 2700K	2870.1	27.5 W	70	10.40
	102-0716	LED-8/24W / 1050 mA - 3000K	2870.1	27.5 W	80	10.40
	102-0716-70	LED-8/24W / 1050 mA - 3000K	3259.9	27.5 W	70	10.40
	102-0717	LED-8/24W / 1050 mA - 4000K	3047.3	27.5 W	80	10.40
	102-0717-70	LED-8/24W / 1050 mA - 4000K	3472.5	27.5 W	70	10.40
	102-0762	LED-16/48W / 1050 mA - 2200K	5052.6	54 W	70	15.40
	102-0763	LED-16/48W / 1050 mA - 2700K	5052.6	54 W	80	15.40
	102-0763-70	LED-16/48W / 1050 mA - 2700K	5456.8	54 W	70	15.40
	102-0764	LED-16/48W / 1050 mA - 3000K	5456.8	54 W	80	15.40
	102-0764-70	LED-16/48W / 1050 mA - 3000K	6197.9	54 W	70	15.40
	102-0765	LED-16/48W / 1050 mA - 4000K	5793.7	54 W	80	15.40
	102-0765-70	LED-16/48W / 1050 mA - 4000K	6602.1	54 W	70	15.40
[S70] Type II Short	102-0430	LED-8/8W / 350 mA - 2200K	989.9	9.5 W	70	10.40
	102-0431	LED-8/8W / 350 mA - 2700K	989.9	9.5 W	80	10.40
	102-0431-70	LED-8/8W / 350 mA - 2700K	1058.1	9.5 W	70	10.40
	102-0432	LED-8/8W / 350 mA - 3000K	1058.1	9.5 W	80	10.40
	102-0432-70	LED-8/8W / 350 mA - 3000K	1228.8	9.5 W	70	10.40
	102-0433	LED-8/8W / 350 mA - 4000K	1160.5	9.5 W	80	10.40
	102-0433-70	LED-8/8W / 350 mA - 4000K	1297	9.5 W	70	10.40

**WE-EF LIGHTING USA, LLC**

410-D Keystone Drive, 15086 Warrendale, PA 15086 - Phone: +1 724 742 0030

customersupport.usa@we-ef.com - <https://we-ef.com/us>

Subject to technical changes and errors. - Generated on 03/15/2026

## Street and Area Lighting

Light distribution	Part ID	Light source	Delivered lumens	Rated input power	CRI	Weight (lb)
	102-0478	LED-16/16W / 350 mA - 2200K	1894.2	18 W	70	10.40
	102-0479	LED-16/16W / 350 mA - 2700K	1894.2	18 W	80	10.40
	102-0479-70	LED-16/16W / 350 mA - 2700K	2024.9	18 W	70	10.40
	102-0480	LED-16/16W / 350 mA - 3000K	2024.9	18 W	80	10.40
	102-0480-70	LED-16/16W / 350 mA - 3000K	2351.4	18 W	70	10.40
	102-0481	LED-16/16W / 350 mA - 4000K	2220.8	18 W	80	10.40
	102-0481-70	LED-16/16W / 350 mA - 4000K	2482.1	18 W	70	10.40
	102-0526	LED-8/12W / 500 mA - 2200K	1365.3	13.5 W	70	10.40
	102-0527	LED-8/12W / 500 mA - 2700K	1365.3	13.5 W	80	10.40
	102-0527-70	LED-8/12W / 500 mA - 2700K	1467.7	13.5 W	70	10.40
	102-0528	LED-8/12W / 500 mA - 3000K	1467.7	13.5 W	80	10.40
	102-0528-70	LED-8/12W / 500 mA - 3000K	1672.5	13.5 W	70	10.40
	102-0529	LED-8/12W / 500 mA - 4000K	1570.1	13.5 W	80	10.40
	102-0529-70	LED-8/12W / 500 mA - 4000K	1774.9	13.5 W	70	10.40
	102-0574	LED-16/24W / 500 mA - 2200K	2612.7	26 W	70	10.40
	102-0575	LED-16/24W / 500 mA - 2700K	2612.7	26 W	80	10.40
	102-0575-70	LED-16/24W / 500 mA - 2700K	2808.7	26 W	70	10.40
	102-0576	LED-16/24W / 500 mA - 3000K	2808.7	26 W	80	10.40
	102-0576-70	LED-16/24W / 500 mA - 3000K	3200.6	26 W	70	10.40
	102-0577	LED-16/24W / 500 mA - 4000K	3004.6	26 W	80	10.40
	102-0577-70	LED-16/24W / 500 mA - 4000K	3396.5	26 W	70	10.40
	102-0622	LED-8/16W / 700 mA - 2200K	1755.4	18 W	70	10.40
	102-0623	LED-8/16W / 700 mA - 2700K	1755.4	18 W	80	10.40
	102-0623-70	LED-8/16W / 700 mA - 2700K	1885.5	18 W	70	10.40
	102-0624	LED-8/16W / 700 mA - 3000K	1885.5	18 W	80	10.40
	102-0624-70	LED-8/16W / 700 mA - 3000K	2145.5	18 W	70	10.40
	102-0625	LED-8/16W / 700 mA - 4000K	2015.5	18 W	80	10.40
	102-0625-70	LED-8/16W / 700 mA - 4000K	2275.6	18 W	70	10.40
	102-0670	LED-16/32W / 700 mA - 2200K	3359.3	35 W	70	10.40
	102-0671	LED-16/32W / 700 mA - 2700K	3359.3	35 W	80	10.40
	102-0671-70	LED-16/32W / 700 mA - 2700K	3608.1	35 W	70	10.40
	102-0672	LED-16/32W / 700 mA - 3000K	3608.1	35 W	80	10.40
	102-0672-70	LED-16/32W / 700 mA - 3000K	4105.8	35 W	70	10.40

## WE-EF LIGHTING USA, LLC

410-D Keystone Drive, 15086 Warrendale, PA 15086 - Phone: +1 724 742 0030

customersupport.usa@we-ef.com - <https://we-ef.com/us>

Subject to technical changes and errors. - Generated on 03/15/2026

**Street and Area Lighting**

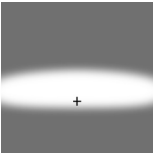
Light distribution	Part ID	Light source	Delivered lumens	Rated input power	CRI	Weight (lb)
	102-0673	LED-16/32W / 700 mA - 4000K	3857	35 W	80	10.40
	102-0673-70	LED-16/32W / 700 mA - 4000K	4354.6	35 W	70	10.40
	102-0718	LED-8/24W / 1050 mA - 2200K	2438.1	27.5 W	70	10.40
	102-0719	LED-8/24W / 1050 mA - 2700K	2438.1	27.5 W	80	10.40
	102-0719-70	LED-8/24W / 1050 mA - 2700K	2633.2	27.5 W	70	10.40
	102-0720	LED-8/24W / 1050 mA - 3000K	2633.2	27.5 W	80	10.40
	102-0720-70	LED-8/24W / 1050 mA - 3000K	2990.8	27.5 W	70	10.40
	102-0721	LED-8/24W / 1050 mA - 4000K	2795.7	27.5 W	80	10.40
	102-0721-70	LED-8/24W / 1050 mA - 4000K	3185.8	27.5 W	70	10.40
	102-0766	LED-16/48W / 1050 mA - 2200K	4665.7	54 W	70	15.40
	102-0767	LED-16/48W / 1050 mA - 2700K	4665.7	54 W	80	15.40
	102-0767-70	LED-16/48W / 1050 mA - 2700K	5038.9	54 W	70	15.40
	102-0768	LED-16/48W / 1050 mA - 3000K	5038.9	54 W	80	15.40
	102-0768-70	LED-16/48W / 1050 mA - 3000K	5723.2	54 W	70	15.40
	102-0769	LED-16/48W / 1050 mA - 4000K	5350	54 W	80	15.40
	102-0769-70	LED-16/48W / 1050 mA - 4000K	6096.5	54 W	70	15.40
asymmetric, side throw [S71] 	102-0462	LED-8/8W / 350 mA - 2200K	903.3	9.5 W	70	10.40
	102-0463	LED-8/8W / 350 mA - 2700K	903.3	9.5 W	80	10.40
	102-0463-70	LED-8/8W / 350 mA - 2700K	965.6	9.5 W	70	10.40
	102-0464	LED-8/8W / 350 mA - 3000K	965.6	9.5 W	80	10.40
	102-0464-70	LED-8/8W / 350 mA - 3000K	1121.3	9.5 W	70	4,70
	102-0465	LED-8/8W / 350 mA - 4000K	1059	9.5 W	80	10.40
	102-0465-70	LED-8/8W / 350 mA - 4000K	1183.6	9.5 W	70	4,70
	102-0510	LED-16/16W / 350 mA - 2200K	1772.4	18 W	70	10.40
	102-0511	LED-16/16W / 350 mA - 2700K	1772.4	18 W	80	10.40
	102-0511-70	LED-16/16W / 350 mA - 2700K	1894.6	18 W	70	10.40
	102-0512	LED-16/16W / 350 mA - 3000K	1894.6	18 W	80	10.40
	102-0512-70	LED-16/16W / 350 mA - 3000K	2200.2	18 W	70	10.40
	102-0513	LED-16/16W / 350 mA - 4000K	2078	18 W	80	10.40
	102-0513-70	LED-16/16W / 350 mA - 4000K	2322.5	18 W	70	10.40
	102-0558	LED-8/12W / 500 mA - 2200K	1245.9	13.5 W	70	10.40
	102-0559	LED-8/12W / 500 mA - 2700K	1245.9	13.5 W	80	10.40
102-0559-70	LED-8/12W / 500 mA - 2700K	1339.3	13.5 W	70	10.40	

**WE-EF LIGHTING USA, LLC**

410-D Keystone Drive, 15086 Warrendale, PA 15086 - Phone: +1 724 742 0030

customersupport.usa@we-ef.com - <https://we-ef.com/us>

Subject to technical changes and errors. - Generated on 03/15/2026

## Street and Area Lighting

Light distribution	Part ID	Light source	Delivered lumens	Rated input power	CRI	Weight (lb)
	102-0560	LED-8/12W / 500 mA - 3000K	1339.3	13.5 W	80	10.40
	102-0560-70	LED-8/12W / 500 mA - 3000K	1526.2	13.5 W	70	10.40
	102-0561	LED-8/12W / 500 mA - 4000K	1432.8	13.5 W	80	10.40
	102-0561-70	LED-8/12W / 500 mA - 4000K	1619.6	13.5 W	70	10.40
	102-0606	LED-16/24W / 500 mA - 2200K	2444.7	26 W	70	10.40
	102-0607	LED-16/24W / 500 mA - 2700K	2444.7	26 W	80	10.40
	102-0607-70	LED-16/24W / 500 mA - 2700K	2628.1	26 W	70	10.40
	102-0608	LED-16/24W / 500 mA - 3000K	2628.1	26 W	80	10.40
	102-0608-70	LED-16/24W / 500 mA - 3000K	2994.8	26 W	70	10.40
	102-0609	LED-16/24W / 500 mA - 4000K	2811.4	26 W	80	10.40
	102-0609-70	LED-16/24W / 500 mA - 4000K	3178.1	26 W	70	10.40
	102-0654	LED-8/16W / 700 mA - 2200K	1601.9	18 W	70	10.40
	102-0655	LED-8/16W / 700 mA - 2700K	1601.9	18 W	80	10.40
	102-0655-70	LED-8/16W / 700 mA - 2700K	1720.5	18 W	70	10.40
	102-0656	LED-8/16W / 700 mA - 3000K	1720.5	18 W	80	10.40
	102-0656-70	LED-8/16W / 700 mA - 3000K	1957.9	18 W	70	10.40
	102-0657	LED-8/16W / 700 mA - 4000K	1839.2	18 W	80	10.40
	102-0657-70	LED-8/16W / 700 mA - 4000K	2076.5	18 W	70	10.40
	102-0702	LED-16/32W / 700 mA - 2200K	3143.3	35 W	70	10.40
	102-0703	LED-16/32W / 700 mA - 2700K	3143.3	35 W	80	10.40
	102-0703-70	LED-16/32W / 700 mA - 2700K	3376.1	35 W	70	10.40
	102-0704	LED-16/32W / 700 mA - 3000K	3376.1	35 W	80	10.40
	102-0704-70	LED-16/32W / 700 mA - 3000K	3841.8	35 W	70	10.40
	102-0705	LED-16/32W / 700 mA - 4000K	3609	35 W	80	10.40
	102-0705-70	LED-16/32W / 700 mA - 4000K	4074.7	35 W	70	10.40
	102-0750	LED-8/24W / 1050 mA - 2200K	2224.8	27.5 W	70	10.40
	102-0751	LED-8/24W / 1050 mA - 2700K	2224.8	27.5 W	80	10.40
	102-0751-70	LED-8/24W / 1050 mA - 2700K	2402.8	27.5 W	70	10.40
	102-0752	LED-8/24W / 1050 mA - 3000K	2402.8	27.5 W	80	10.40
	102-0752-70	LED-8/24W / 1050 mA - 3000K	2729.1	27.5 W	70	10.40
	102-0753	LED-8/24W / 1050 mA - 4000K	2551.1	27.5 W	80	10.40
	102-0753-70	LED-8/24W / 1050 mA - 4000K	2907.1	27.5 W	70	10.40
	102-0798	LED-16/48W / 1050 mA - 2200K	4365.7	54 W	70	15.40

## WE-EF LIGHTING USA, LLC

410-D Keystone Drive, 15086 Warrendale, PA 15086 - Phone: +1 724 742 0030

customersupport.usa@we-ef.com - <https://we-ef.com/us>

Subject to technical changes and errors. - Generated on 03/15/2026

**Street and Area Lighting**

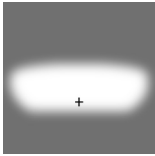
Light distribution	Part ID	Light source	Delivered lumens	Rated input power	CRI	Weight (lb)
	102-0799	LED-16/48W / 1050 mA - 2700K	4365.7	54 W	80	15.40
	102-0799-70	LED-16/48W / 1050 mA - 2700K	4715	54 W	70	15.40
	102-0800	LED-16/48W / 1050 mA - 3000K	4715	54 W	80	15.40
	102-0800-70	LED-16/48W / 1050 mA - 3000K	5355.3	54 W	70	15.40
	102-0801	LED-16/48W / 1050 mA - 4000K	5006	54 W	80	15.40
	102-0801-70	LED-16/48W / 1050 mA - 4000K	5704.5	54 W	70	15.40
asymmetric, side throw beam [S66]	102-0458	LED-8/8W / 350 mA - 2200K	1053.1	9.5 W	70	10.40
	102-0459	LED-8/8W / 350 mA - 2700K	1053.1	9.5 W	80	10.40
	102-0459-70	LED-8/8W / 350 mA - 2700K	1125.7	9.5 W	70	10.40
	102-0460	LED-8/8W / 350 mA - 3000K	1125.7	9.5 W	80	10.40
	102-0460-70	LED-8/8W / 350 mA - 3000K	1307.3	9.5 W	70	10.40
	102-0461	LED-8/8W / 350 mA - 4000K	1234.6	9.5 W	80	10.40
	102-0461-70	LED-8/8W / 350 mA - 4000K	1379.9	9.5 W	70	10.40
	102-0506	LED-16/16W / 350 mA - 2200K	2013.3	18 W	70	10.40
	102-0507	LED-16/16W / 350 mA - 2700K	2013.3	18 W	80	10.40
	102-0507-70	LED-16/16W / 350 mA - 2700K	2152.2	18 W	70	10.40
	102-0508	LED-16/16W / 350 mA - 3000K	2152.2	18 W	80	10.40
	102-0508-70	LED-16/16W / 350 mA - 3000K	2499.3	18 W	70	10.40
	102-0509	LED-16/16W / 350 mA - 4000K	2360.4	18 W	80	10.40
	102-0509-70	LED-16/16W / 350 mA - 4000K	2638.1	18 W	70	10.40
	102-0554	LED-8/12W / 500 mA - 2200K	1452.5	13.5 W	70	10.40
	102-0555	LED-8/12W / 500 mA - 2700K	1452.5	13.5 W	80	10.40
	102-0555-70	LED-8/12W / 500 mA - 2700K	1561.5	13.5 W	70	10.40
	102-0556	LED-8/12W / 500 mA - 3000K	1561.5	13.5 W	80	10.40
	102-0556-70	LED-8/12W / 500 mA - 3000K	1779.3	13.5 W	70	10.40
	102-0557	LED-8/12W / 500 mA - 4000K	1670.4	13.5 W	80	10.40
	102-0557-70	LED-8/12W / 500 mA - 4000K	1888.3	13.5 W	70	10.40
	102-0602	LED-16/24W / 500 mA - 2200K	2777	26 W	70	10.40
	102-0603	LED-16/24W / 500 mA - 2700K	2777	26 W	80	10.40
	102-0603-70	LED-16/24W / 500 mA - 2700K	2985.3	26 W	70	10.40
	102-0604	LED-16/24W / 500 mA - 3000K	2985.3	26 W	80	10.40
	102-0604-70	LED-16/24W / 500 mA - 3000K	3401.8	26 W	70	10.40
	102-0605	LED-16/24W / 500 mA - 4000K	3193.5	26 W	80	10.40

**WE-EF LIGHTING USA, LLC**

410-D Keystone Drive, 15086 Warrendale, PA 15086 - Phone: +1 724 742 0030

customersupport.usa@we-ef.com - <https://we-ef.com/us>

Subject to technical changes and errors. - Generated on 03/15/2026

## Street and Area Lighting

Light distribution	Part ID	Light source	Delivered lumens	Rated input power	CRI	Weight (lb)
	102-0605-70	LED-16/24W / 500 mA - 4000K	3610.1	26 W	70	10.40
	102-0650	LED-8/16W / 700 mA - 2200K	1867.6	18 W	70	10.40
	102-0651	LED-8/16W / 700 mA - 2700K	1867.6	18 W	80	10.40
	102-0651-70	LED-8/16W / 700 mA - 2700K	2005.9	18 W	70	10.40
	102-0652	LED-8/16W / 700 mA - 3000K	2005.9	18 W	80	10.40
	102-0652-70	LED-8/16W / 700 mA - 3000K	2282.6	18 W	70	10.40
	102-0653	LED-8/16W / 700 mA - 4000K	2144.3	18 W	80	10.40
	102-0653-70	LED-8/16W / 700 mA - 4000K	2420.9	18 W	70	10.40
	102-0698	LED-16/32W / 700 mA - 2200K	3570.5	35 W	70	10.40
	102-0699	LED-16/32W / 700 mA - 2700K	3570.5	35 W	80	10.40
	102-0699-70	LED-16/32W / 700 mA - 2700K	3835	35 W	70	10.40
	102-0700	LED-16/32W / 700 mA - 3000K	3835	35 W	80	10.40
	102-0700-70	LED-16/32W / 700 mA - 3000K	4364	35 W	70	10.40
	102-0701	LED-16/32W / 700 mA - 4000K	4099.5	35 W	80	10.40
	102-0701-70	LED-16/32W / 700 mA - 4000K	4628.5	35 W	70	10.40
	102-0746	LED-8/24W / 1050 mA - 2200K	2593.9	27.5 W	70	10.40
	102-0747	LED-8/24W / 1050 mA - 2700K	2593.9	27.5 W	80	10.40
	102-0747-70	LED-8/24W / 1050 mA - 2700K	2801.4	27.5 W	70	10.40
	102-0748	LED-8/24W / 1050 mA - 3000K	2801.4	27.5 W	80	10.40
	102-0748-70	LED-8/24W / 1050 mA - 3000K	3181.8	27.5 W	70	10.40
	102-0749	LED-8/24W / 1050 mA - 4000K	2974.3	27.5 W	80	10.40
	102-0749-70	LED-8/24W / 1050 mA - 4000K	3389.3	27.5 W	70	10.40
	102-0794	LED-16/48W / 1050 mA - 2200K	4959.1	54 W	70	15.40
	102-0795	LED-16/48W / 1050 mA - 2700K	4959.1	54 W	80	10.40
	102-0795-70	LED-16/48W / 1050 mA - 2700K	5355.8	54 W	70	15.40
	102-0796	LED-16/48W / 1050 mA - 3000K	5355.8	54 W	80	15.40
	102-0796-70	LED-16/48W / 1050 mA - 3000K	6083.1	54 W	70	15.40
	102-0797	LED-16/48W / 1050 mA - 4000K	5686.4	54 W	80	15.40
	102-0797-70	LED-16/48W / 1050 mA - 4000K	6479.8	54 W	70	15.40
pedestrian crossing, left-hand traffic [P46L]	102-0454	LED-8/8W / 350 mA - 2200K	1073.7	9.5 W	70	10.40
	102-0455	LED-8/8W / 350 mA - 2700K	1073.7	9.5 W	80	10.40
	102-0455-70	LED-8/8W / 350 mA - 2700K	1147.7	9.5 W	70	10.40
	102-0456	LED-8/8W / 350 mA - 3000K	1147.7	9.5 W	80	10.40

## WE-EF LIGHTING USA, LLC

410-D Keystone Drive, 15086 Warrendale, PA 15086 - Phone: +1 724 742 0030

customersupport.usa@we-ef.com - <https://we-ef.com/us>

Subject to technical changes and errors. - Generated on 03/15/2026

## Street and Area Lighting

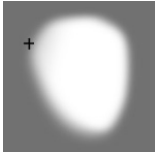
Light distribution	Part ID	Light source	Delivered lumens	Rated input power	CRI	Weight (lb)
	102-0456-70	LED-8/8W / 350 mA - 3000K	1332.8	9.5 W	70	10.40
	102-0457	LED-8/8W / 350 mA - 4000K	1258.8	9.5 W	80	10.40
	102-0457-70	LED-8/8W / 350 mA - 4000K	1406.9	9.5 W	70	10.40
	102-0502	LED-16/16W / 350 mA - 2200K	2073.6	18 W	70	10.40
	102-0503	LED-16/16W / 350 mA - 2700K	2073.6	18 W	80	10.40
	102-0503-70	LED-16/16W / 350 mA - 2700K	2216.6	18 W	70	10.40
	102-0504	LED-16/16W / 350 mA - 3000K	2216.6	18 W	80	10.40
	102-0504-70	LED-16/16W / 350 mA - 3000K	2574.2	18 W	70	10.40
	102-0505	LED-16/16W / 350 mA - 4000K	2431.2	18 W	80	10.40
	102-0505-70	LED-16/16W / 350 mA - 4000K	2717.2	18 W	70	10.40
	102-0550	LED-8/12W / 500 mA - 2200K	1480.9	13.5 W	70	10.40
	102-0551	LED-8/12W / 500 mA - 2700K	1480.9	13.5 W	80	10.40
	102-0551-70	LED-8/12W / 500 mA - 2700K	1592	13.5 W	70	10.40
	102-0552	LED-8/12W / 500 mA - 3000K	1592	13.5 W	80	10.40
	102-0552-70	LED-8/12W / 500 mA - 3000K	1814.1	13.5 W	70	10.40
	102-0553	LED-8/12W / 500 mA - 4000K	1703	13.5 W	80	10.40
	102-0553-70	LED-8/12W / 500 mA - 4000K	1925.2	13.5 W	70	10.40
	102-0598	LED-16/24W / 500 mA - 2200K	3234.8	26 W	70	10.40
	102-0599	LED-16/24W / 500 mA - 2700K	2860.2	26 W	80	10.40
	102-0599-70	LED-16/24W / 500 mA - 2700K	3074.7	26 W	70	10.40
	102-0600	LED-16/24W / 500 mA - 3000K	3074.7	26 W	80	10.40
	102-0600-70	LED-16/24W / 500 mA - 3000K	3503.7	26 W	70	10.40
	102-0601	LED-16/24W / 500 mA - 4000K	3289.2	26 W	80	10.40
	102-0601-70	LED-16/24W / 500 mA - 4000K	3718.2	26 W	70	10.40
	102-0646	LED-8/16W / 700 mA - 2200K	1904.1	18 W	70	10.40
	102-0647	LED-8/16W / 700 mA - 2700K	1904.1	18 W	80	10.40
	102-0647-70	LED-8/16W / 700 mA - 2700K	2045.1	18 W	70	10.40
	102-0648	LED-8/16W / 700 mA - 3000K	2045.1	18 W	80	10.40
	102-0648-70	LED-8/16W / 700 mA - 3000K	2327.2	18 W	70	10.40
	102-0649	LED-8/16W / 700 mA - 4000K	2186.2	18 W	80	10.40
	102-0649-70	LED-8/16W / 700 mA - 4000K	2468.3	18 W	70	10.40
	102-0694	LED-16/32W / 700 mA - 2200K	3677.5	35 W	70	10.40
102-0695	LED-16/32W / 700 mA - 2700K	3677.5	35 W	80	10.40	

## WE-EF LIGHTING USA, LLC

410-D Keystone Drive, 15086 Warrendale, PA 15086 - Phone: +1 724 742 0030

customersupport.usa@we-ef.com - <https://we-ef.com/us>

Subject to technical changes and errors. - Generated on 03/15/2026

**Street and Area Lighting**

Light distribution	Part ID	Light source	Delivered lumens	Rated input power	CRI	Weight (lb)
	102-0695-70	LED-16/32W / 700 mA - 2700K	3949.9	35 W	70	10.40
	102-0696	LED-16/32W / 700 mA - 3000K	3949.9	35 W	80	10.40
	102-0696-70	LED-16/32W / 700 mA - 3000K	4494.7	35 W	70	10.40
	102-0697	LED-16/32W / 700 mA - 4000K	4222.3	35 W	80	10.40
	102-0697-70	LED-16/32W / 700 mA - 4000K	4767.1	35 W	70	10.40
	102-0742	LED-8/24W / 1050 mA - 2200K	2644.6	27.5 W	70	10.40
	102-0743	LED-8/24W / 1050 mA - 2700K	2644.6	27.5 W	80	10.40
	102-0743-70	LED-8/24W / 1050 mA - 2700K	2856.1	27.5 W	70	10.40
	102-0744	LED-8/24W / 1050 mA - 3000K	2856.1	27.5 W	80	10.40
	102-0744-70	LED-8/24W / 1050 mA - 3000K	3244	27.5 W	70	10.40
	102-0745	LED-8/24W / 1050 mA - 4000K	3032.5	27.5 W	80	10.40
	102-0745-70	LED-8/24W / 1050 mA - 4000K	3455.6	27.5 W	70	15.40
	102-0790	LED-16/48W / 1050 mA - 2200K	5107.6	54 W	70	15.40
	102-0791	LED-16/48W / 1050 mA - 2700K	5107.6	54 W	80	15.40
	102-0791-70	LED-16/48W / 1050 mA - 2700K	5516.2	54 W	70	15.40
	102-0792	LED-16/48W / 1050 mA - 3000K	5516.2	54 W	80	15.40
	102-0792-70	LED-16/48W / 1050 mA - 3000K	6265.3	54 W	70	15.40
	102-0793	LED-16/48W / 1050 mA - 4000K	5856.7	54 W	80	15.40
	102-0793-70	LED-16/48W / 1050 mA - 4000K	6673.9	54 W	70	15.40
pedestrian crossing, right-hand traffic [P46R]	102-0450	LED-8/8W / 350 mA - 2200K	1066.4	9.5 W	70	10.40
	102-0451	LED-8/8W / 350 mA - 2700K	1066.4	9.5 W	80	10.40
	102-0451-70	LED-8/8W / 350 mA - 2700K	1140	9.5 W	70	10.40
	102-0452	LED-8/8W / 350 mA - 3000K	1140	9.5 W	80	10.40
	102-0452-70	LED-8/8W / 350 mA - 3000K	1323.8	9.5 W	70	10.40
	102-0453	LED-8/8W / 350 mA - 4000K	1250.3	9.5 W	80	10.40
	102-0453-70	LED-8/8W / 350 mA - 4000K	1397.4	9.5 W	70	10.40
	102-0498	LED-16/16W / 350 mA - 2200K	2039.3	18 W	70	10.40
	102-0499	LED-16/16W / 350 mA - 2700K	2039.3	18 W	80	10.40
	102-0499-70	LED-16/16W / 350 mA - 2700K	2180	18 W	70	10.40
	102-0500	LED-16/16W / 350 mA - 3000K	2180	18 W	80	10.40
	102-0500-70	LED-16/16W / 350 mA - 3000K	2531.6	18 W	70	15.40
	102-0501	LED-16/16W / 350 mA - 4000K	2390.9	18 W	80	10.40
	102-0501-70	LED-16/16W / 350 mA - 4000K	2672.2	18 W	70	10.40



**WE-EF LIGHTING USA, LLC**

410-D Keystone Drive, 15086 Warrendale, PA 15086 - Phone: +1 724 742 0030

customersupport.usa@we-ef.com - <https://we-ef.com/us>

Subject to technical changes and errors. - Generated on 03/15/2026

## Street and Area Lighting

Light distribution	Part ID	Light source	Delivered lumens	Rated input power	CRI	Weight (lb)
	102-0546	LED-8/12W / 500 mA - 2200K	1470.9	13.5 W	70	10.40
	102-0547	LED-8/12W / 500 mA - 2700K	1470.9	13.5 W	80	10.40
	102-0547-70	LED-8/12W / 500 mA - 2700K	1581.2	13.5 W	70	10.40
	102-0548	LED-8/12W / 500 mA - 3000K	1581.2	13.5 W	80	10.40
	102-0548-70	LED-8/12W / 500 mA - 3000K	1581.2	13.5 W	70	10.40
	102-0549	LED-8/12W / 500 mA - 4000K	1691.5	13.5 W	80	10.40
	102-0549-70	LED-8/12W / 500 mA - 4000K	1912.2	13.5 W	70	10.40
	102-0594	LED-16/24W / 500 mA - 2200K	2812.9	26 W	70	10.40
	102-0595	LED-16/24W / 500 mA - 2700K	2812.9	26 W	80	10.40
	102-0595-70	LED-16/24W / 500 mA - 2700K	3023.8	26 W	70	10.40
	102-0596	LED-16/24W / 500 mA - 3000K	3023.8	26 W	80	10.40
	102-0596-70	LED-16/24W / 500 mA - 3000K	3445.8	26 W	70	10.40
	102-0597	LED-16/24W / 500 mA - 4000K	3234.8	26 W	80	10.40
	102-0597-70	LED-16/24W / 500 mA - 4000K	3656.7	26 W	70	10.40
	102-0642	LED-8/16W / 700 mA - 2200K	1891.3	18 W	70	10.40
	102-0643	LED-8/16W / 700 mA - 2700K	1891.3	18 W	80	10.40
	102-0643-70	LED-8/16W / 700 mA - 2700K	2031.3	18 W	70	10.40
	102-0644	LED-8/16W / 700 mA - 3000K	2031.3	18 W	80	10.40
	102-0644-70	LED-8/16W / 700 mA - 3000K	2311.5	18 W	70	10.40
	102-0645	LED-8/16W / 700 mA - 4000K	2171.4	18 W	80	10.40
	102-0645-70	LED-8/16W / 700 mA - 4000K	2451.6	18 W	70	10.40
	102-0690	LED-16/32W / 700 mA - 2200K	3616.7	35 W	70	10.40
	102-0691	LED-16/32W / 700 mA - 2700K	3616.7	35 W	80	10.40
	102-0691-70	LED-16/32W / 700 mA - 2700K	3884.6	35 W	70	10.40
	102-0692	LED-16/32W / 700 mA - 3000K	3884.6	35 W	80	10.40
	102-0692-70	LED-16/32W / 700 mA - 3000K	4420.4	35 W	70	10.40
	102-0693	LED-16/32W / 700 mA - 4000K	4152.5	35 W	80	10.40
	102-0693-70	LED-16/32W / 700 mA - 4000K	4688.3	35 W	70	10.40
	102-0738	LED-8/24W / 1050 mA - 2200K	2626.7	27.5 W	70	10.40
	102-0739	LED-8/24W / 1050 mA - 2700K	2626.7	27.5 W	80	10.40
	102-0739-70	LED-8/24W / 1050 mA - 2700K	2836.9	27.5 W	70	10.40
	102-0740	LED-8/24W / 1050 mA - 3000K	2836.9	27.5 W	80	10.40
	102-0740-70	LED-8/24W / 1050 mA - 3000K	3222.1	27.5 W	70	10.40

## WE-EF LIGHTING USA, LLC

410-D Keystone Drive, 15086 Warrendale, PA 15086 - Phone: +1 724 742 0030

customersupport.usa@we-ef.com - <https://we-ef.com/us>

Subject to technical changes and errors. - Generated on 03/15/2026

## Street and Area Lighting

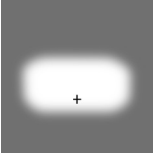
Light distribution	Part ID	Light source	Delivered lumens	Rated input power	CRI	Weight (lb)
	102-0741	LED-8/24W / 1050 mA - 4000K	3012	27.5 W	80	10.40
	102-0741-70	LED-8/24W / 1050 mA - 4000K	3432.3	27.5 W	70	10.40
	102-0786	LED-16/48W / 1050 mA - 2200K	5023.1	54 W	70	15.40
	102-0787	LED-16/48W / 1050 mA - 2700K	5023.1	54 W	80	15.40
	102-0787-70	LED-16/48W / 1050 mA - 2700K	5425	54 W	70	15.40
	102-0788	LED-16/48W / 1050 mA - 3000K	5425	54 W	80	15.40
	102-0788-70	LED-16/48W / 1050 mA - 3000K	6161.7	54 W	70	15.40
	102-0789	LED-16/48W / 1050 mA - 4000K	5759.9	54 W	80	15.40
	102-0789-70	LED-16/48W / 1050 mA - 4000K	6563.6	54 W	70	15.40
rectangular, side throw [R60]	102-0434	LED-8/8W / 350 mA - 2200K	926.2	9.5 W	70	10.40
	102-0435	LED-8/8W / 350 mA - 2700K	926.2	9.5 W	80	10.40
	102-0435-70	LED-8/8W / 350 mA - 2700K	990.1	9.5 W	70	10.40
	102-0436	LED-8/8W / 350 mA - 3000K	990.1	9.5 W	80	10.40
	102-0436-70	LED-8/8W / 350 mA - 3000K	1149.8	9.5 W	70	10.40
	102-0437	LED-8/8W / 350 mA - 4000K	1085.9	9.5 W	80	10.40
	102-0437-70	LED-8/8W / 350 mA - 4000K	1213.7	9.5 W	70	10.40
	102-0482	LED-16/16W / 350 mA - 2200K	1765.6	18 W	70	10.40
	102-0483	LED-16/16W / 350 mA - 2700K	1765.6	18 W	80	10.40
	102-0483-70	LED-16/16W / 350 mA - 2700K	1887.3	18 W	70	10.40
	102-0484	LED-16/16W / 350 mA - 3000K	1887.3	18 W	80	10.40
	102-0484-70	LED-16/16W / 350 mA - 3000K	2191.7	18 W	70	10.40
	102-0485	LED-16/16W / 350 mA - 4000K	2070	18 W	80	10.40
	102-0485-70	LED-16/16W / 350 mA - 4000K	2313.5	18 W	70	10.40
	102-0530	LED-8/12W / 500 mA - 2200K	1277.5	13.5 W	70	10.40
	102-0531	LED-8/12W / 500 mA - 2700K	1277.5	13.5 W	80	10.40
	102-0531-70	LED-8/12W / 500 mA - 2700K	1373.3	13.5 W	70	10.40
	102-0532	LED-8/12W / 500 mA - 3000K	1373.3	13.5 W	80	10.40
	102-0532-70	LED-8/12W / 500 mA - 3000K	1565	13.5 W	70	10.40
	102-0533	LED-8/12W / 500 mA - 4000K	1469.2	13.5 W	80	10.40
	102-0533-70	LED-8/12W / 500 mA - 4000K	1660.8	13.5 W	70	10.40
	102-0578	LED-16/24W / 500 mA - 2200K	2435.3	26 W	70	10.40
	102-0579	LED-16/24W / 500 mA - 2700K	2435.3	26 W	80	10.40
	102-0579-70	LED-16/24W / 500 mA - 2700K	2617.9	26 W	70	10.40

## WE-EF LIGHTING USA, LLC

410-D Keystone Drive, 15086 Warrendale, PA 15086 - Phone: +1 724 742 0030

customersupport.usa@we-ef.com - <https://we-ef.com/us>

Subject to technical changes and errors. - Generated on 03/15/2026

## Street and Area Lighting

Light distribution	Part ID	Light source	Delivered lumens	Rated input power	CRI	Weight (lb)
	102-0580	LED-16/24W / 500 mA - 3000K	2617.9	26 W	80	10.40
	102-0580-70	LED-16/24W / 500 mA - 3000K	2983.2	26 W	70	10.40
	102-0581	LED-16/24W / 500 mA - 4000K	2800.5	26 W	80	10.40
	102-0581-70	LED-16/24W / 500 mA - 4000K	3165.8	26 W	70	10.40
	102-0626	LED-8/16W / 700 mA - 2200K	1642.6	18 W	70	10.40
	102-0627	LED-8/16W / 700 mA - 2700K	1642.6	18 W	80	10.40
	102-0627-70	LED-8/16W / 700 mA - 2700K	1764.2	18 W	70	10.40
	102-0628	LED-8/16W / 700 mA - 3000K	1764.2	18 W	80	10.40
	102-0628-70	LED-8/16W / 700 mA - 3000K	2007.6	18 W	70	10.40
	102-0629	LED-8/16W / 700 mA - 4000K	1885.9	18 W	80	10.40
	102-0629-70	LED-8/16W / 700 mA - 4000K	2129.3	18 W	70	10.40
	102-0674	LED-16/32W / 700 mA - 2200K	3131.1	35 W	70	10.40
	102-0675	LED-16/32W / 700 mA - 2700K	3131.1	35 W	80	10.40
	102-0675-70	LED-16/32W / 700 mA - 2700K	3363.1	35 W	70	10.40
	102-0676	LED-16/32W / 700 mA - 3000K	3363.1	35 W	80	10.40
	102-0676-70	LED-16/32W / 700 mA - 3000K	3826.9	35 W	70	10.40
	102-0677	LED-16/32W / 700 mA - 4000K	3595	35 W	80	10.40
	102-0677-70	LED-16/32W / 700 mA - 4000K	4058.9	35 W	70	10.40
	102-0722	LED-8/24W / 1050 mA - 2200K	2281.3	27.5 W	70	10.40
	102-0723	LED-8/24W / 1050 mA - 2700K	2281.3	27.5 W	80	10.40
	102-0723-70	LED-8/24W / 1050 mA - 2700K	2463.9	27.5 W	70	10.40
	102-0724	LED-8/24W / 1050 mA - 3000K	2463.9	27.5 W	80	10.40
	102-0724-70	LED-8/24W / 1050 mA - 3000K	2798.5	27.5 W	70	10.40
	102-0725	LED-8/24W / 1050 mA - 4000K	2615.9	27.5 W	80	10.40
	102-0725-70	LED-8/24W / 1050 mA - 4000K	2981	27.5 W	70	10.40
	102-0770	LED-16/48W / 1050 mA - 2200K	4348.8	54 W	70	15.40
	102-0771	LED-16/48W / 1050 mA - 2700K	4348.8	54 W	80	15.40
	102-0771-70	LED-16/48W / 1050 mA - 2700K	4696.7	54 W	70	15.40
	102-0772	LED-16/48W / 1050 mA - 3000K	4696.7	54 W	80	15.40
	102-0772-70	LED-16/48W / 1050 mA - 3000K	5334.5	54 W	70	15.40
	102-0773	LED-16/48W / 1050 mA - 4000K	4986.6	54 W	80	15.40
	102-0773-70	LED-16/48W / 1050 mA - 4000K	5682.4	54 W	70	15.40
rectangular, side throw [R61]	102-0466	LED-8/8W / 350 mA - 2200K	888.3	9.5 W	70	10.40

## WE-EF LIGHTING USA, LLC

410-D Keystone Drive, 15086 Warrendale, PA 15086 - Phone: +1 724 742 0030

customersupport.usa@we-ef.com - <https://we-ef.com/us>

Subject to technical changes and errors. - Generated on 03/15/2026

**Street and Area Lighting**

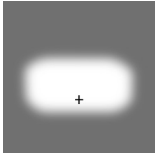
Light distribution	Part ID	Light source	Delivered lumens	Rated input power	CRI	Weight (lb)
	102-0467	LED-8/8W / 350 mA - 2700K	888.3	9.5 W	80	10.40
	102-0467-70	LED-8/8W / 350 mA - 2700K	949.6	9.5 W	70	10.40
	102-0468	LED-8/8W / 350 mA - 3000K	949.6	9.5 W	80	10.40
	102-0468-70	LED-8/8W / 350 mA - 3000K	1102.8	9.5 W	70	10.40
	102-0469	LED-8/8W / 350 mA - 4000K	1041.5	9.5 W	80	10.40
	102-0469-70	LED-8/8W / 350 mA - 4000K	1164	9.5 W	70	10.40
	102-0514	LED-16/16W / 350 mA - 2200K	1723.6	18 W	70	10.40
	102-0515	LED-16/16W / 350 mA - 2700K	1723.6	18 W	80	10.40
	102-0515-70	LED-16/16W / 350 mA - 2700K	1842.4	18 W	70	10.40
	102-0516	LED-16/16W / 350 mA - 3000K	1842.4	18 W	80	10.40
	102-0516-70	LED-16/16W / 350 mA - 3000K	2139.6	18 W	70	10.40
	102-0517	LED-16/16W / 350 mA - 4000K	2020.7	18 W	80	10.40
	102-0517-70	LED-16/16W / 350 mA - 4000K	2258.5	18 W	70	10.40
	102-0562	LED-8/12W / 500 mA - 2200K	1225.3	13.5 W	70	10.40
	102-0563	LED-8/12W / 500 mA - 2700K	1225.3	13.5 W	80	10.40
	102-0563-70	LED-8/12W / 500 mA - 2700K	1317.2	13.5 W	70	10.40
	102-0564	LED-8/12W / 500 mA - 3000K	1317.2	13.5 W	80	10.40
	102-0564-70	LED-8/12W / 500 mA - 3000K	1501	13.5 W	70	10.40
	102-0565	LED-8/12W / 500 mA - 4000K	1409.1	13.5 W	80	10.40
	102-0565-70	LED-8/12W / 500 mA - 4000K	1592.9	13.5 W	70	10.40
	102-0610	LED-16/24W / 500 mA - 2200K	2377.3	26 W	70	10.40
	102-0611	LED-16/24W / 500 mA - 2700K	2377.3	26 W	80	15.40
	102-0611-70	LED-16/24W / 500 mA - 2700K	2555.6	26 W	70	10.40
	102-0612	LED-16/24W / 500 mA - 3000K	2555.6	26 W	80	10.40
	102-0612-70	LED-16/24W / 500 mA - 3000K	2912.2	26 W	70	10.40
	102-0613	LED-16/24W / 500 mA - 4000K	2733.9	26 W	80	10.40
	102-0613-70	LED-16/24W / 500 mA - 4000K	3090.5	26 W	70	10.40
	102-0658	LED-8/16W / 700 mA - 2200K	1575.4	18 W	70	10.40
	102-0659	LED-8/16W / 700 mA - 2700K	1575.4	18 W	80	10.40
	102-0659-70	LED-8/16W / 700 mA - 2700K	1692.1	18 W	70	10.40
	102-0660	LED-8/16W / 700 mA - 3000K	1692.1	18 W	80	10.40
	102-0660-70	LED-8/16W / 700 mA - 3000K	1925.5	18 W	70	10.40
	102-0661	LED-8/16W / 700 mA - 4000K	1808.8	18 W	80	10.40

**WE-EF LIGHTING USA, LLC**

410-D Keystone Drive, 15086 Warrendale, PA 15086 - Phone: +1 724 742 0030

customersupport.usa@we-ef.com - <https://we-ef.com/us>

Subject to technical changes and errors. - Generated on 03/15/2026

## Street and Area Lighting

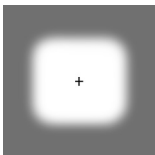
Light distribution	Part ID	Light source	Delivered lumens	Rated input power	CRI	Weight (lb)
	102-0661-70	LED-8/16W / 700 mA - 4000K	2042.2	18 W	70	10.40
	102-0706	LED-16/32W / 700 mA - 2200K	3056.7	35 W	70	10.40
	102-0707	LED-16/32W / 700 mA - 2700K	3056.7	35 W	80	10.40
	102-0707-70	LED-16/32W / 700 mA - 2700K	3283.1	35 W	70	10.40
	102-0708	LED-16/32W / 700 mA - 3000K	3283.1	35 W	80	10.40
	102-0708-70	LED-16/32W / 700 mA - 3000K	3735.9	35 W	70	10.40
	102-0709	LED-16/32W / 700 mA - 4000K	3509.5	35 W	80	10.40
	102-0709-70	LED-16/32W / 700 mA - 4000K	3962.3	35 W	70	10.40
	102-0754	LED-8/24W / 1050 mA - 2200K	2188.1	27.5 W	70	10.40
	102-0755	LED-8/24W / 1050 mA - 2700K	2188.1	27.5 W	80	10.40
	102-0755-70	LED-8/24W / 1050 mA - 2700K	2363.1	27.5 W	70	10.40
	102-0756	LED-8/24W / 1050 mA - 3000K	2363.1	27.5 W	80	10.40
	102-0756-70	LED-8/24W / 1050 mA - 3000K	2684	27.5 W	70	10.40
	102-0757	LED-8/24W / 1050 mA - 4000K	2509	27.5 W	80	10.40
	102-0757-70	LED-8/24W / 1050 mA - 4000K	2859.1	27.5 W	70	10.40
	102-0802	LED-16/48W / 1050 mA - 2200K	4245.3	54 W	70	15.40
	102-0803	LED-16/48W / 1050 mA - 2700K	4245.3	54 W	80	15.40
	102-0803-70	LED-16/48W / 1050 mA - 2700K	4585	54 W	70	15.40
	102-0804	LED-16/48W / 1050 mA - 3000K	4585	54 W	80	15.40
	102-0804-70	LED-16/48W / 1050 mA - 3000K	5207.6	54 W	70	15.40
	102-0805	LED-16/48W / 1050 mA - 4000K	4868	54 W	80	15.40
	102-0805-70	LED-16/48W / 1050 mA - 4000K	5547.3	54 W	70	15.40
square distribution [Q66]	102-0446	LED-8/8W / 350 mA - 2200K	930.6	9.5 W	70	10.40
	102-0447	LED-8/8W / 350 mA - 2700K	930.6	9.5 W	80	10.40
	102-0447-70	LED-8/8W / 350 mA - 2700K	994.8	9.5 W	70	10.40
	102-0448	LED-8/8W / 350 mA - 3000K	994.8	9.5 W	80	10.40
	102-0448-70	LED-8/8W / 350 mA - 3000K	1155.2	9.5 W	70	10.40
	102-0449	LED-8/8W / 350 mA - 4000K	1091.1	9.5 W	80	10.40
	102-0449-70	LED-8/8W / 350 mA - 4000K	1219.4	9.5 W	70	10.40
	102-0494	LED-16/16W / 350 mA - 2200K	1747.8	18 W	70	10.40
	102-0495	LED-16/16W / 350 mA - 2700K	1747.8	18 W	80	10.40
	102-0495-70	LED-16/16W / 350 mA - 2700K	1868.3	18 W	70	10.40
	102-0496	LED-16/16W / 350 mA - 3000K	1868.3	18 W	80	10.40

## WE-EF LIGHTING USA, LLC

410-D Keystone Drive, 15086 Warrendale, PA 15086 - Phone: +1 724 742 0030

customersupport.usa@we-ef.com - <https://we-ef.com/us>

Subject to technical changes and errors. - Generated on 03/15/2026

## Street and Area Lighting

Light distribution	Part ID	Light source	Delivered lumens	Rated input power	CRI	Weight (lb)
	102-0496-70	LED-16/16W / 350 mA - 3000K	2169.7	18 W	70	10.40
	102-0497	LED-16/16W / 350 mA - 4000K	2049.1	18 W	80	10.40
	102-0497-70	LED-16/16W / 350 mA - 4000K	2290.2	18 W	70	10.40
	102-0542	LED-8/12W / 500 mA - 2200K	1283.6	13.5 W	70	10.40
	102-0543	LED-8/12W / 500 mA - 2700K	1283.6	13.5 W	80	10.40
	102-0543-70	LED-8/12W / 500 mA - 2700K	1379.9	13.5 W	70	10.40
	102-0544	LED-8/12W / 500 mA - 3000K	1379.9	13.5 W	80	10.40
	102-0544-70	LED-8/12W / 500 mA - 3000K	1572.4	13.5 W	70	10.40
	102-0545	LED-8/12W / 500 mA - 4000K	1476.1	13.5 W	80	10.40
	102-0545-70	LED-8/12W / 500 mA - 4000K	1668.7	13.5 W	70	10.40
	102-0590	LED-16/24W / 500 mA - 2200K	2410.8	26 W	70	10.40
	102-0591	LED-16/24W / 500 mA - 2700K	2410.8	26 W	80	10.40
	102-0591-70	LED-16/24W / 500 mA - 2700K	2591.6	26 W	70	10.40
	102-0592	LED-16/24W / 500 mA - 3000K	2591.6	26 W	80	10.40
	102-0592-70	LED-16/24W / 500 mA - 3000K	2953.2	26 W	70	10.40
	102-0593	LED-16/24W / 500 mA - 4000K	2772.4	26 W	80	10.40
	102-0593-70	LED-16/24W / 500 mA - 4000K	3134	26 W	70	10.40
	102-0638	LED-8/16W / 700 mA - 2200K	1650.4	18 W	70	10.40
	102-0639	LED-8/16W / 700 mA - 2700K	1650.4	18 W	80	10.40
	102-0639-70	LED-8/16W / 700 mA - 2700K	1772.6	18 W	70	10.40
	102-0640	LED-8/16W / 700 mA - 3000K	1772.6	18 W	80	10.40
	102-0640-70	LED-8/16W / 700 mA - 3000K	2017.1	18 W	70	10.40
	102-0641	LED-8/16W / 700 mA - 4000K	1894.9	18 W	80	10.40
	102-0641-70	LED-8/16W / 700 mA - 4000K	2139.4	18 W	70	10.40
	102-0686	LED-16/32W / 700 mA - 2200K	3099.6	35 W	70	10.40
	102-0687	LED-16/32W / 700 mA - 2700K	3099.6	35 W	80	10.40
	102-0687-70	LED-16/32W / 700 mA - 2700K	3329.2	35 W	70	10.40
	102-0688	LED-16/32W / 700 mA - 3000K	3329.2	35 W	80	10.40
	102-0688-70	LED-16/32W / 700 mA - 3000K	3788.4	35 W	70	10.40
	102-0689	LED-16/32W / 700 mA - 4000K	3558.8	35 W	80	10.40
	102-0689-70	LED-16/32W / 700 mA - 4000K	4018	35 W	70	10.40
	102-0734	LED-8/24W / 1050 mA - 2200K	2292.2	27.5 W	70	10.40
	102-0735	LED-8/24W / 1050 mA - 2700K	2292.2	27.5 W	80	10.40

## WE-EF LIGHTING USA, LLC

410-D Keystone Drive, 15086 Warrendale, PA 15086 - Phone: +1 724 742 0030

customersupport.usa@we-ef.com - <https://we-ef.com/us>

Subject to technical changes and errors. - Generated on 03/15/2026

## Street and Area Lighting

Light distribution	Part ID	Light source	Delivered lumens	Rated input power	CRI	Weight (lb)
	102-0735-70	LED-8/24W / 1050 mA - 2700K	2475.6	27.5 W	70	10.40
	102-0736	LED-8/24W / 1050 mA - 3000K	2475.6	27.5 W	80	10.40
	102-0736-70	LED-8/24W / 1050 mA - 3000K	2811.8	27.5 W	70	10.40
	102-0737	LED-8/24W / 1050 mA - 4000K	2628.4	27.5 W	80	10.40
	102-0737-70	LED-8/24W / 1050 mA - 4000K	2995.2	27.5 W	70	10.40
	102-0782	LED-16/48W / 1050 mA - 2200K	4305	54 W	70	15.40
	102-0783	LED-16/48W / 1050 mA - 2700K	4305	54 W	80	15.40
	102-0783-70	LED-16/48W / 1050 mA - 2700K	4649.4	54 W	70	15.40
	102-0784	LED-16/48W / 1050 mA - 3000K	4649.4	54 W	80	15.40
	102-0784-70	LED-16/48W / 1050 mA - 3000K	5280.8	54 W	70	15.40
	102-0785	LED-16/48W / 1050 mA - 4000K	4936.4	54 W	80	15.40
	102-0785-70	LED-16/48W / 1050 mA - 4000K	5625.2	54 W	70	15.40

**Mounting Accessories**

**Bird deterrent**

---

Description	Part ID
Bird deterrent BD	430-0015

---

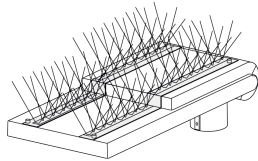

**Street and Area Lighting**

**Adaptor**

Description	Part ID
Adaptor AFL100	102-0392

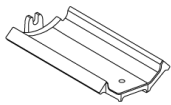

**Wall and pole brackets RE**

Description	Part ID	C1	D1	D2	D × L1	H1	M1	Weight (lb)
RE2-540 Pole bracket, double	111-0043	7.87			3 x 5	21.65		11.68

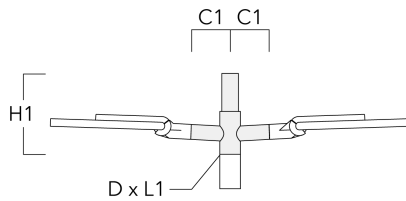

**Street and Area Lighting**

Description	Part ID	C1	D1	D2	D × L1	H1	M1	Weight (lb)
RE0-540 Wall bracket	111-0084	7.09	9.06	7.68			0.47	7.05

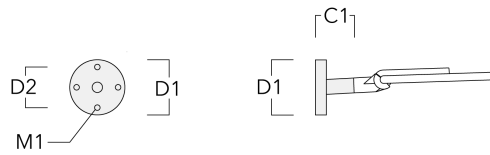

RE1-540 Pole bracket, single	111-0042	200			3 x 5	500		4.60
------------------------------	----------	-----	--	--	-------	-----	--	------

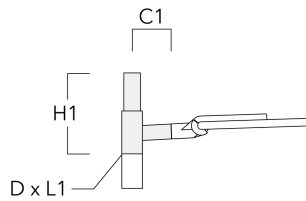

**Street and Area Lighting**

**Pole brackets RF**

Description	Part ID	C1	D × L1	H1	Weight (lb)
RF2-540 Pole bracket, double	111-0047	7.87	3 x 3	7.87	7.28

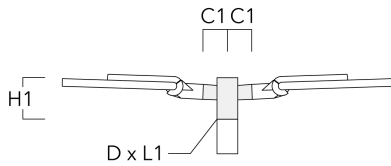

RF1-540 Pole bracket, single	111-0046	200	3 x 3	200	2.60
------------------------------	----------	-----	-------	-----	------

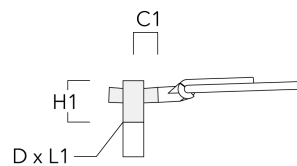

**Street and Area Lighting**

**Wall and pole brackets RX**

Description	Part ID	C1	D1	D2	D × L1	H1	H2	M1	M2	Weight (lb)
RX1-540 Pole bracket, single	111-0054	39.37			2.99 x 3.15	21.65				14.99

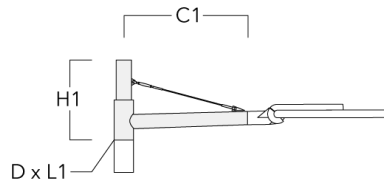

RX2-540 Pole bracket, double	111-0055	39.37			2.99 x 3.15	21.65				21.38
------------------------------	----------	-------	--	--	-------------	-------	--	--	--	-------

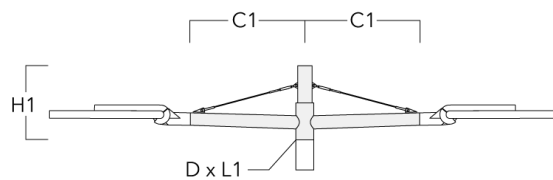

**Street and Area Lighting**

Description	Part ID	C1	D1	D2	D × L1	H1	H2	M1	M2	Weight (lb)
RX0-540 Wall bracket	111-0086	39.37	5.51	3.94		17.72	15.16	1.18	0.47	11.46

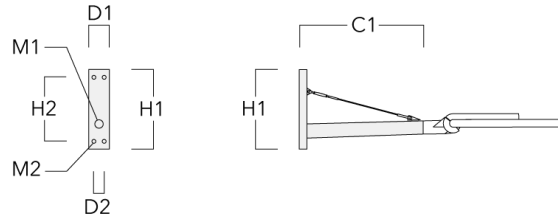

**Optical Accessories**

**Backlight shield**

Description	Part ID	Additional information
LS180	430-0029	Glare Shield for backlight spill. Glare Shield factory-installed or available as retrofit kit. Suitable for [S61][S65][S66][S70][S71][R60][R61][P66][Q66][A61] lenses. Must be specified at time of ordering.

