

CFT540-CC LED

Pole mounted

we-ef

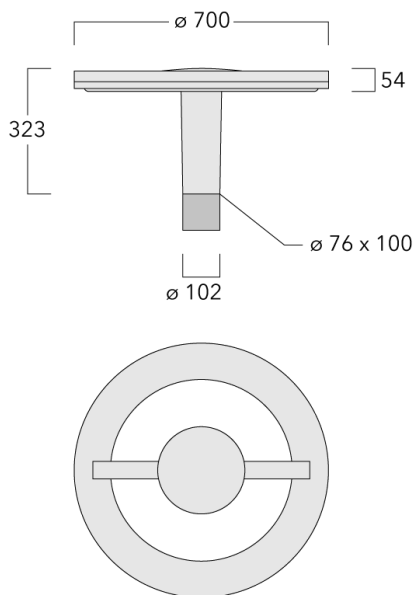
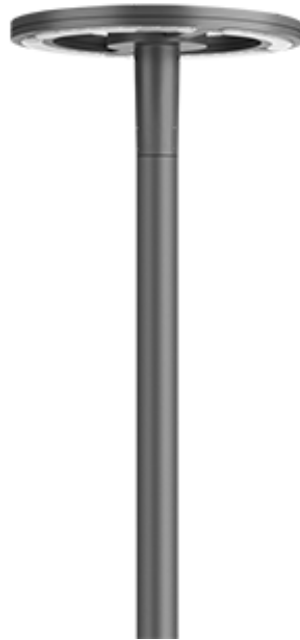

Description

RGBW/RGBA Colour Changer. IP66. Class I. IK08. Marine-grade, die-cast aluminium alloy. 5CE superior corrosion protection including PCS hardware. Silicone CCG® Controlled Compression Gasket. RFC® Reflection Free Contour main lens. Integral EC electronic converter in thermally separated compartment. DMX interface. CAD-optimised optics for superior illumination and glare control. OLC® One LED Concept. Factory installed LED circuit board. The luminaire is factory-sealed and does not need to be opened during installation.

WE-EF LEUCHTEN GmbH





Töpinger Straße 16, 29646 Bispingen, Germany - Phone: +49 5194 909-0
info@we-ef.com - <https://we-ef.com>

Subject to technical changes and errors. - Generated on 23/11/2024

Pole mounted

Specifications

Material description

Body	Marine-grade, die-cast aluminium alloy
Lens	PMMA RFC® Reflection Free Contour technology
Colours	 RAL9004 Signal black  RAL9006 White aluminium  RAL9007 Grey aluminium  RAL7016 Anthracite grey  RAL9016 Traffic white
Gasket	Silicone CCG® Controlled Compression Gasket
Fasteners	PCS Polymer Coated Stainless Steel Hardware
Ingress protection	IP66
Impact resistance	IK08
Corrosion resistance	5CE
Windage	0.24 m ²

Electrical description

Power supply	220-240V / 50-60 Hz
Driver / Ballast	Integral EC electronic converter. DMX
Power factor	> 0.9
Surge protection	6/6 kV (optional SP10)

Additional information

Lifetime	Ta=25° L90B10 > 90000h
ENERGY EFFICIENCY CLASS	C-D (Light source)

CFT540-CC LED

Pole mounted

we-ef

Options

Light distribution



controlled symmetric distribution [C50]



rectangular [R]

Colour temperature

RGBW/3K

RGBW/4K

RGBA

Nominal Watt

42 W

Configurations

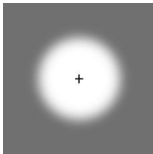
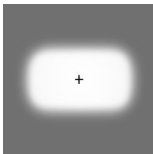
Light distribution	Part ID	Light source	Rated lumens	Rated input power	CRI	Weight (kg)
controlled symmetric distribution [C50] 	105-0315	LED-36/95W - RGBW/3K	7077.6	99 W	20/80	13.30
	105-0339	LED-36/95W - RGBW/4K	7077.6	99 W	20/80	13.30
	105-0340	LED-36/95W/230mA - RGBA (PCA)	5750.5	99 W	20	13.30
rectangular [R] 	105-0341	LED-36/95W - RGBW/3K	6689.1	99 W	20/80	13.30
	105-0342	LED-36/95W - RGBW/4K	6689.1	99 W	20/80	13.30
	105-0343	LED-36/95W/230mA - RGBA (PCA)	5434.9	99 W	20	13.30

CFT540-CC LED

Pole mounted



Electrical Accessories

DMX Luminaire

Description	Part ID
DMX Communication IN&OUT + Power Supply Cable	430-0012

WE-EF LEUCHTEN GmbH

Töpinger Straße 16, 29646 Bispingen, Germany - Phone: +49 5194 909-0
info@we-ef.com - <https://we-ef.com>

Subject to technical changes and errors. - Generated on 23/11/2024

CFT540-CC LED

Pole mounted

we-ef

Control

DMX Wireless Antenna

Description	Part ID
Antenna RF 5dB	430-0036
Antenna RF1.8dB	430-0018

WE-EF LEUCHTEN GmbH

Töpinger Straße 16, 29646 Bispingen, Germany - Phone: +49 5194 909-0
info@we-ef.com - <https://we-ef.com>

Subject to technical changes and errors. - Generated on 23/11/2024