**Description**





Solar (ISP - integrated solar panel fully independent). IP66, Class III. IK08. Marine-grade, die-cast aluminium alloy. 5CE superior corrosion protection including PCS hardware. CCG® Controlled Compression Gasket. Non-reflective flat safety glass cover, hinged. Combined LED driver, battery charger and light control unit. CAD-optimised optics for superior illumination and glare control. OLC® One LED Concept. Factory installed LED circuit board. The luminaire is factory-sealed and does not need to be opened during installation. Flush installation of the solar module with the housing for a clean finish. Alignment of the solar panel only in combination with the luminaire. Can be used as post top or side entry version. Specification at time of order is recommended.

Spigot \varnothing 76 x 100 mm. Spigot \varnothing 60 x 100 mm or 42 x 100 mm option available. Must be indicated during order placement.

Contact WE-EF direct or your local WE-EF sales representative for an individual solution designed to precisely meet your needs.

Photometric files (IES, LDT) for light distributions [S70] [R60] [A61] [P66] with Backlight Shield on request.

Specifications**Material description**

Body	Marine-grade, die-cast aluminium alloy
Lens	Non-reflective safety glass lens
Colours	 RAL9004 Signal black  RAL9006 White aluminium  RAL9007 Grey aluminium  RAL7016 Anthracite grey  RAL9016 Traffic white
Gasket	CCG® Controlled Compression Gasket
Fasteners	PCS Polymer Coated Stainless Steel Hardware
Ingress protection	IP66
Impact resistance	IK08
Corrosion resistance	5CE
Windage	0.191 m ²

Electrical description

Power supply	220-240V / 50-60 Hz
Driver / Ballast	Integral EC electronic converter. DALI
Power factor	> 0.9
Surge protection	6/6kV, optional 10kV

Additional information

Lifetime	Ta=25° L90B10 > 90000h
Energy efficiency class	C-D (Light source)

AFL130-ISP

Pole mounted

we-ef

Options

Light distribution

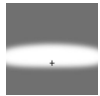

asymmetric, side throw [S70]



rectangular, side throw [R60]



asymmetric, forward throw [A61]

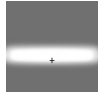

pedestrian/bicycle lane [P66]

Colour temperature



2700 K



1850 K

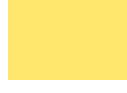

3000 K

Nominal Watt

11 W

24 W

Configurations

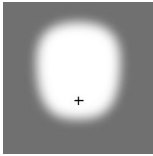
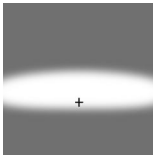
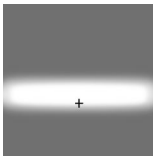
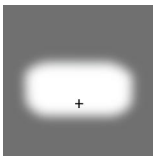
Light distribution	Part ID	Light source	Rated lumens	Rated input power	CRI	Weight (kg)
asymmetric, forward throw [A61] 	102-0808	LED-24/11W / 160 mA - 2700K	1533.7	12 W	80	7.00
	102-0812	LED-24/7,5W / 160 mA - Amber	385.6	8 W	80	7.00
	102-0816	LED-24/11W / 160 mA - PCA	1134.9	12 W	80	7.00
	102-1000	LED-24/11W / 160 mA - 3000K	1638.8	12 W	80	7.00
asymmetric, side throw [S70] 	102-0806	LED-24/11W / 160 mA - 2700K	1659.7	12 W	80	7.00
	102-0810	LED-24/7,5W / 160 mA - Amber	417.3	8 W	80	7.00
	102-0814	LED-24/11W / 160 mA - PCA	1228.2	12 W	80	7.00
	102-0998	LED-24/11W / 160 mA - 3000K	1773.5	12 W	80	7.00
pedestrian/bicycle lane [P66] 	102-0809	LED-24/11W / 160 mA - 2700K	1550.6	12 W	80	7.00
	102-0813	LED-24/7,5W / 160 mA - Amber	389.9	8 W	80	7.00
	102-0817	LED-24/11W / 160 mA - PCA	1147.5	12 W	80	7.00
	102-1001	LED-24/11W / 160 mA - 3000K	1657	12 W	80	7.00
rectangular, side throw [R60] 	102-0807	LED-24/11W / 160 mA - 2700K	1529.2	12 W	80	7.00
	102-0811	LED-24/7,5W / 160 mA - Amber	384.5	8 W	80	7.00
	102-0815	LED-24/11W / 160 mA - PCA	1131.6	12 W	80	7.00
	102-0999	LED-24/11W / 160 mA - 3000K	1634.1	12 W	80	7.00

Mounting Accessories

Adaptor

Description	Part ID
Adaptor AFL100	102-0392

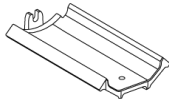

Optical Accessories**Backlight shield**

Description	Part ID	Additional information
LS180	430-0029	Glare Shield for backlight spill. Glare Shield factory-installed or available as retrofit kit. Suitable for [S61][S66][R61][P66][Q66][A61] lenses. Must be specified at time of ordering.

