

ETC130-GB LED

Inground luminaires

we-ef



WE-EF LEUCHTEN GmbH

Töpinger Straße 16, 29646 Bispingen, Germany - Phone: +49 5194 909-0
info@we-ef.com - <https://we-ef.com>

Subject to technical changes and errors. - Generated on 23/11/2024

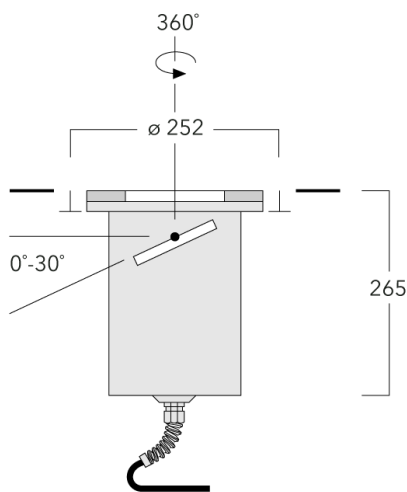

Description

IP67*, Class I. IK10+. Stainless steel construction including PCS hardware. Silicone rubber gasket. Safety glass lens; max. load 5 tonnes. Luminaire can be driven over at low speed. Factory-sealed termination chamber complete with cable gland and 1.5 m of flexible PVC free cable. Cable gland with spiral cable bending protection. Integral EC electronic converter in thermally separated compartment. 'No tool' removable gear/lens tray. CAD-optimised optics for superior illumination and glare control. OLC® One LED Concept. Factory installed LED circuit board. Gimbal mounted, 360° rotatable and 30° tiltable.

The optional installation blackout is recommended for mounting. To be ordered separately.

Optional with Anti-Slip ceramic Coating ASC to DIN 51130 (Trip Classification 10) available on request.

The luminaire is not suitable for permanent underwater operation and must be switched off in the event of flooding.

* Additionally tested to IP66, IP67, IP68 0.1 bar 3h, up to 1 m depth according to DIN EN 60598 and IP69K/80° according to DIN EN 60529.

Specifications**Material description**

Body	Stainless steel construcion
Lens	Safety glass lens; max. load 5 tonnes
Colours	 Stainless Steel
Gasket	Silicone rubber gasket
Fasteners	PCS polymer coated stainless steel
Ingress protection	IP67
Impact resistance	IK10+
Corrosion resistance	5CE

Electrical description

Power supply	220-240V / 50-60 Hz
Driver / Ballast	Integral EC electronic converter
Power factor	> 0.9
Surge protection	1/2 kV (optional SP10)

Additional information

Lifetime	Ta=25° L90B10 > 90000h
Energy efficiency class	C-D (Light source)

Options

Light distribution



symmetric, medium beam [M]



symmetric, very narrow beam, sharp cut-off [EES]



linear spread, very narrow beam, sharp cut-off [EES]



symmetric, wide beam [B]



symmetric, very narrow beam [EE]



linear spread, very narrow beam [EE]



wallwash



asymmetric, wallgrazer [A6]

Colour temperature



3000 K



4000 K





2700 K

Nominal Watt

21 W

0 W

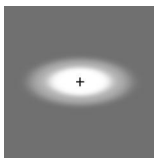
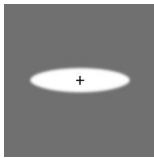
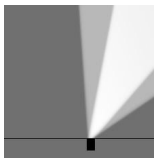
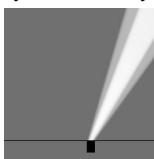
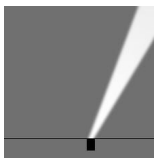
Configurations

Light distribution	Part ID	Light source	Rated lumens	Rated input power	CRI	Weight (kg)
asymmetric, wallgrazer [A6] 	185-3686	LED-12/18W / 500 mA - 3000 K	1995.6	21 W	80	6.20
	185-3687	LED-12/18W / 500 mA - 4000 K	2134.8	21 W	80	6.20
	185-3691	LED-12/18W / 500 mA - 2700 K	1856.4	21 W	80	6.20
linear spread, very narrow beam [EE] 	185-2661+185-2632	LED-12/18W / 500 mA - 3000 K	1973.5	21 W	80	6.20
	185-2662+185-2632	LED-12/18W / 500 mA - 4000 K	2111.2	21 W	80	6.20
	185-3141+185-2632	LED-12/18W / 500 mA - 2700 K	1835.8	21 W	80	6.20
linear spread, very narrow beam, sharp cut-off [EES] 	185-2591+185-2632	LED-12/18W / 500 mA - 3000 K	2061	21 W	80	6.20
	185-2592+185-2632	LED-12/18W / 500 mA - 4000 K	2204.8	21 W	80	6.20
	185-3542+185-2632	LED-12/18W / 500 mA - 2700 K	1917.2	21 W	80	6.20
symmetric, medium beam [M] 	185-2446	LED-12/18W / 500 mA - 3000 K	2238.7	21 W	80	6.20
	185-2447	LED-12/18W / 500 mA - 4000 K	2394.8	21 W	80	6.20
	185-3527	LED-12/18W / 500 mA - 2700 K	2082.5	21 W	80	6.20
symmetric, very narrow beam [EE] 	185-2661	LED-12/18W / 500 mA - 3000 K	2113.4	21 W	80	6.20
	185-2662	LED-12/18W / 500 mA - 4000 K	2260.9	21 W	80	6.20
	185-3141	LED-12/18W / 500 mA - 2700 K	1966	21 W	80	6.20
symmetric, very narrow beam, sharp cut-off [EES] 	185-2591	LED-12/18W / 500 mA - 3000 K	2248.6	21 W	80	6.20
	185-2592	LED-12/18W / 500 mA - 4000 K	2405.5	21 W	80	6.20
	185-3542	LED-12/18W / 500 mA - 2700 K	2091.8	21 W	80	6.20
symmetric, wide beam [B] 	185-2658	LED-12/18W / 500 mA - 3000 K	1950.6	21 W	80	6.20
	185-2659	LED-12/18W / 500 mA - 4000 K	2086.6	21 W	80	6.20
	185-3541	LED-12/18W / 500 mA - 2700 K	1814.5	21 W	80	6.20
wallwash	185-3091	LED-12/18W / 500 mA - 3000 K	1802.7	21 W	80	6.20

ETC130-GB LED

Inground luminaires

Light distribution	Part ID	Light source	Rated lumens	Rated input power	CRI	Weight (kg)
	185-3092	LED-12/18W / 500 mA - 4000 K	1928.5	21 W	80	6.20
	185-3707	LED-12/18W / 500 mA - 2700 K	1676.9	21 W	80	6.20

WE-EF LEUCHTEN GmbH

Töpinger Straße 16, 29646 Bispingen, Germany - Phone: +49 5194 909-0
info@we-ef.com - <https://we-ef.com>

Subject to technical changes and errors. - Generated on 23/11/2024

Mounting Accessories

Installation blackout

Description	Part ID	D1	D2	H1	Weight (kg)	D	H
Blockout, Plastic	185-0322	250	270	375	1.50	250/270	375

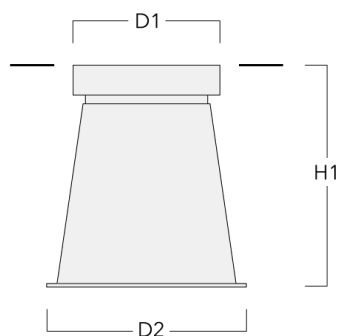

Installation cover

Description	Part ID	C1
Installation cover BE	185-0325	250

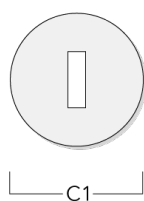

Electrical Accessories

Sealable junction box

Description	Part ID	C1	M1	M2
Sealable junction box SJB130	185-1624	146	Ø 10	Ø 12 - 19

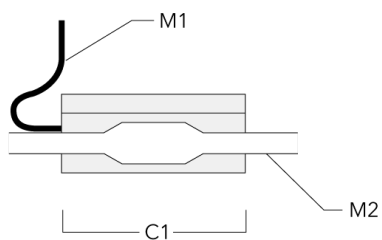

Optical Accessories**Linear spread lens**

Description	Part ID	Additional information	C1
IO-180 ETC130/330-GB LED	185-2632		98

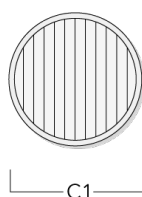

IO-180-DAC120-LED	134-2000	Broadens light distribution in one plane only. Ideally suitable for [M][EE][EES]. Does not fit in combination with [B] lens. A maximum of one internal optical accessory. Internal component, factory installed.	130
-------------------	----------	---	-----

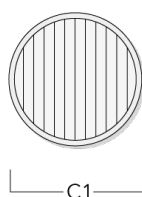

ETC130-GB LED

Inground luminaires

Flood lens

Description	Part ID	C1
IO-360-ETC130-GB-LED	185-2866	98

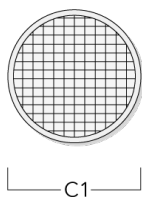

Honeycomb louvre

Description	Part ID	C1
IW-ETC130/330-GB-LED - [M][EE] [EES]	185-2870	98

