

STN204 LED

Wall luminaires recessed



Description

IP55, Class I. IK10. Marine-grade, die-cast aluminium alloy. 5CE superior corrosion protection including PCS hardware. Silicone rubber gasket. Polycarbonate main lens. Two cable entries.

A pre-installation blockout is available and recommended for mounting in concrete walls. To be ordered separately.

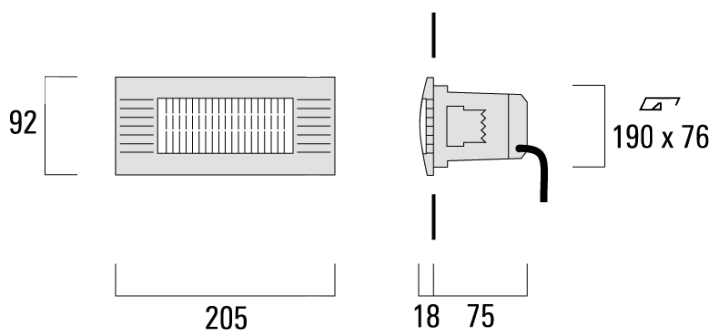

Fagerhult Lighting Ltd

33-34 Dolben Street, SE1 0UQ London, United Kingdom

<https://we-ef.com/uk>





Subject to technical changes and errors. - Generated on 23/11/2024

STN204 LED

Wall luminaires recessed

Specifications

Material description

Body	Marine-grade, die-cast aluminium alloy
Lens	Polycarbonate
Colours	 RAL9004 Signal black  RAL9006 White aluminium  RAL9007 Grey aluminium  RAL7016 Anthracite grey  RAL9016 Traffic white
Gasket	Silicone rubber gasket
Fasteners	PCS Polymer Coated Stainless Steel Hardware
Ingress protection	IP55
Impact resistance	IK10
Corrosion resistance	5CE

Electrical description

Power supply	220-240V / 50-60 Hz
Driver / Ballast	Integral EC electronic converter

Additional information

Lifetime	LED >60,000 h Ta 25°(L70/B10) Control gear >50,000 h Ta 25°
----------	--

STN204 LED

Wall luminaires recessed

we-ef

Options

Light distribution Colour temperature Nominal Watt

STN204 LED

Wall luminaires recessed



Configurations

Light distribution	Part ID	Light source	Rated lumens	Rated input power	CRI	Weight (kg)
--------------------	---------	--------------	--------------	-------------------	-----	-------------

Fagerhult Lighting Ltd

33-34 Dolben Street, SE1 0UQ London, United Kingdom

<https://we-ef.com/uk>

Subject to technical changes and errors. - Generated on 23/11/2024

Mounting Accessories

Installation blackout

Description	Part ID	A	B	C1	C
Installation blackout BST20-I	133-0075	222	109	105	105

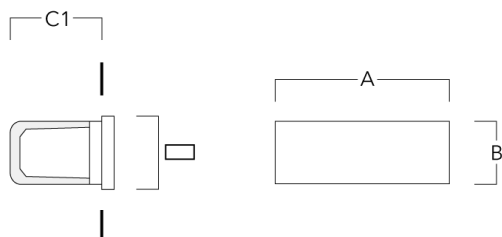

Installation blackout BST20-II	133-0077	222	109	115	115
--------------------------------	----------	-----	-----	-----	-----

