

QLS420 LED

Surface Mounted Wall Luminaires

we-ef

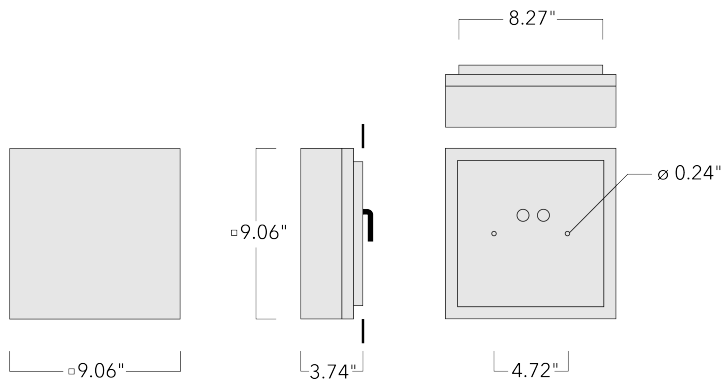

Description

IP66, Class I, IK07. Surface mounted LED wall luminaire. Marine-grade, die-cast aluminum alloy. 5CE superior corrosion protection including PCS hardware. Silicone CCG® Controlled Compression Gasket. Safety glass lens. Integral driver. CAD-optimized optics for superior illumination and glare control. OLC® One LED Concept. Factory installed LED circuit board. 0-10V Dimming on request. Suitable for installation over 4" recessed junction box. Optional 2200 K version up to max. 1050mA available. To be specified at time of ordering.

ADA (American Disabilities Act) Compliant.

For DarkSky compliant configurations of this product, please find the spec sheet and DarkSky certificate in the library.

WE-EF LIGHTING USA, LLC

410-D Keystone Drive, 15086 Warrendale, PA 15086 - Phone: +1 724 742 0030

customersupport.usa@we-ef.com - <https://we-ef.com/us>





Subject to technical changes and errors. - Generated on 10/23/2024

QLS420 LED

Surface Mounted Wall Luminaires

Specifications

Material description

Body	Luminaire body and lens frame constructed in die cast aluminum.
Lens	Clear tempered glass lens.
Colors	 RAL9004 Black  RAL9007 Grey Metallic  RAL9016 White  RAL8019 Dark Bronze
Gasket	Silicone CCG® Controlled Compression Gasket
Fasteners	PCS polymer coated stainless steel
Ingress protection	IP66
Impact resistance	IK07
Corrosion resistance	5CE

Electrical description

Power supply	Integral [ECG] electronic driver 120V-277V. 0-10V dimmable, to be specified with order.
Driver / Ballast	Integral EC electronic converter

Additional information

Lifetime	Ta=25°/40° L90B10 > 90000h
BUG Rating	Please see individual Spec Sheets for classification of Backlight, Uplight and Glare.
Listings	ETL listed. Suitable for wet locations.

WE-EF LIGHTING USA, LLC

410-D Keystone Drive, 15086 Warrendale, PA 15086 - Phone: +1 724 742 0030

customersupport.usa@we-ef.com - <https://we-ef.com/us>

Subject to technical changes and errors. - Generated on 10/23/2024

QLS420 LED

Surface Mounted Wall Luminaires

Options

Light distribution



symmetric, medium beam [M]



symmetric, medium beam up and down [M/M]



asymmetric, side throw beam [S]



symmetric, medium beam up and side throw down [M/S]



symmetric, narrow beam up and side-throw down [N/S]



symmetric, narrow beam [N]



symmetric, narrow beam up and down [N/N]



rectangular asymmetric Type II [R45]



medium beam up and forward throw down [M/R45]



symmetric narrow beam up and forward throw down [E/R45]



symmetric, narrow beam up and medium beam down [N/M]



rectangular, side throw [R45/R45]

Color temperature

Nominal Watt



3000 K

18 W

36 W



4000 K

24 W

0 W



2700 K



WE-EF LIGHTING USA, LLC

410-D Keystone Drive, 15086 Warrendale, PA 15086 - Phone: +1 724 742 0030

customersupport.usa@we-ef.com - <https://we-ef.com/us>

Subject to technical changes and errors. - Generated on 10/23/2024

Configurations

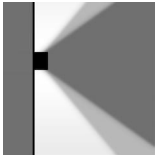
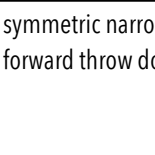
Light distribution	Part ID	Light source	Rated lumens	Rated input power	CRI	Weight (lb)
asymmetric, side throw beam [S] 	131-7030	LED-6/18W / 1050 mA - 2700 K	1566	21 W	80	6.80
	131-7033	LED-6/26W / 1400 mA - 2700 K	1986.2	29 W	80	6.80
	131-9426	LED-6/12W / 700 mA - 2700 K	1031.3	14.5 W	80	6.8
	131-9437	LED-6/12W / 700 mA - 3000 K	1107.7	14.5 W	80	6.80
	131-9440	LED-6/12W / 700 mA - 4000 K	1184.1	14.5 W	80	6.80
medium beam up and forward throw down [M/R45] 	131-9456	LED-2x6/24W / 700 mA - 3000 K	2357.7	27 W	80	6.80
	131-9458	LED-2x6/24W / 700 mA - 4000 K	2520.3	27 W	80	6.80
	131-9701	LED-2x6/24W / 700 mA - 2700 K	2195.1	27 W	80	6.80
	131-9754	LED-2x6/36W / 1050 mA - 3000 K	3495.8	41 W	80	6.80
	131-9759	LED-2x6/36W / 1050 mA - 4000 K	3658.4	41 W	80	6.80
	131-9764	LED-2x6/52W / 1400mA - 3000 K	4471.4	55 W	80	6.88
	131-9769	LED-2x6/52W / 1400mA - 4000 K	4674.7	55 W	80	6.80
	131-9896	LED-2x6/36W / 1050 mA - 2700 K	3333.2	41 W	80	6.80
	131-9905	LED-2x6/52W / 1400 mA - 2700 K	4227.5	55 W	80	6.80
rectangular asymmetric Type II [R45] 	131-0190	LED-6/18W / 1050 mA - 3000 K	1756.2	21 W	80	6.80
	131-0191	LED-6/18W / 1050 mA - 4000 K	1837.9	21 W	80	6.80
	131-0196	LED-6/26W / 1400 mA - 3000 K	2246.3	29 W	80	6.80
	131-0197	LED-6/26W / 1400 mA - 4000 K	2348.4	29 W	80	6.80
	131-9455	LED-6/12W / 700 mA - 3000 K	1184.4	14.5 W	80	6.80
	131-9457	LED-6/12W / 700 mA - 4000 K	1266.1	14.5 W	80	6.80
	131-9700	LED-6/12W / 700 mA - 2700 K	1102.7	14.5 W	80	6.80
	131-9895	LED-6/18W / 1050 mA - 2700 K	1674.5	21 W	80	6.80
	131-9904	LED-6/26W / 1400 mA - 2700 K	2123.8	29 W	80	6.80
rectangular, side throw [R45/R45] 	131-9703	LED-2x6/24W / 700 mA - 2700 K	4411	27 W	80	6.80
	131-9898	LED-2x6/36W / 1050 mA - 2700 K	6698.2	41 W	80	6.80
	131-9907	LED-2x6/52W / 1400 mA - 2700 K	8495.3	55 W	80	6.80
symmetric narrow beam up and forward throw down [E/R45] 	131-9464	LED-2x6/24W / 700 mA - 3000 K	2498.7	27 W	80	6.80
	131-9465	LED-2x6/24W / 700 mA - 4000 K	2671	27 W	80	6.80
	131-9702	LED-2x6/24W / 700 mA - 2700 K	2326.4	27 W	80	6.80
	131-9755	LED-2x6/36W / 1050 mA - 3000 K	3705	41 W	80	6.80
	131-9760	LED-2x6/36W / 1050 mA - 4000 K	3877.3	41 W	80	6.80

WE-EF LIGHTING USA, LLC

410-D Keystone Drive, 15086 Warrendale, PA 15086 - Phone: +1 724 742 0030

customersupport.usa@we-ef.com - <https://we-ef.com/us>

Subject to technical changes and errors. - Generated on 10/23/2024

QLS420 LED

Surface Mounted Wall Luminaires

Light distribution	Part ID	Light source	Rated lumens	Rated input power	CRI	Weight (lb)
	131-9765	LED-2x6/52W / 1400mA - 3000 K	4738.9	55 W	80	6.88
	131-9770	LED-2x6/52W / 1400mA - 4000 K	4954.3	55 W	80	6.88
	131-9897	LED-2x6/36W / 1050 mA - 2700 K	3532.7	41 W	80	6.80
	131-9906	LED-2x6/52W / 1400 mA - 2700 K	4480.4	55 W	80	6.80
symmetric, medium beam [M] 	131-0186	LED-6/18W / 1050 mA - 3000 K	1739.1	21 W	80	6.80
	131-0187	LED-6/18W / 1050 mA - 4000 K	1820	21 W	80	6.80
	131-0192	LED-6/26W / 1400 mA - 3000 K	2224.5	29 W	80	6.80
	131-0193	LED-6/26W / 1400 mA - 4000 K	2325.6	29 W	80	6.80
	131-9427	LED-6/12W / 700 mA - 2700 K	1092	14.5 W	80	6.8
	131-9438	LED-6/12W / 700 mA - 3000 K	1172.9	14.5 W	80	6.80
	131-9441	LED-6/12W / 700 mA - 4000 K	1253.8	14.5 W	80	6.80
	131-9886	LED-6/18W / 1050 mA - 2700 K	1658.3	21 W	80	6.80
	131-9888	LED-6/26W / 1400 mA - 2700 K	2103.2	29 W	80	6.80
	symmetric, medium beam up and down [M/M] 	131-9431	LED-2x6/24W / 700 mA - 2700 K	2184.4	27 W	80
131-9446		LED-2x6/24W / 700 mA - 3000 K	2346.2	27 W	80	6.80
131-9451		LED-2x6/24W / 700 mA - 4000 K	2508.1	27 W	80	6.80
131-9756		LED-2x6/36W / 1050 mA - 3000 K	3478.9	41 W	80	6.80
131-9761		LED-2x6/36W / 1050 mA - 4000 K	3640.7	41 W	80	6.80
131-9766		LED-2x6/52W / 1400mA - 3000 K	4449.8	55 W	80	6.88
131-9771		LED-2x6/52W / 1400mA - 4000 K	4652	55 W	80	6.88
131-9892		LED-2x6/36W / 1050 mA - 2700 K	3317.1	41 W	80	6.80
131-9901		LED-2x6/52W / 1400 mA - 2700 K	4207.1	55 W	80	6.80
symmetric, medium beam up and side throw down [M/S] 		131-7036	LED-2x6/36W / 1050 mA - 2700 K	3224.3	41 W	80
	131-7039	LED-2x6/52W / 1400 mA - 2700 K	4089.4	55 W	80	6.80
	131-9429	LED-2x6/24W / 700 mA - 2700 K	2123.3	27 W	80	6.8
	131-9444	LED-2x6/24W / 700 mA - 3000 K	2280.6	27 W	80	6.80
	131-9449	LED-2x6/24W / 700 mA - 4000 K	2437.9	27 W	80	6.80
symmetric, narrow beam [N] 	131-0188	LED-6/18W / 1050 mA - 3000 K	1948	21 W	80	6.80
	131-0189	LED-6/18W / 1050 mA - 4000 K	2038.6	21 W	80	6.80
	131-0194	LED-6/26W / 1400 mA - 3000 K	2491.7	29 W	80	6.80
	131-0195	LED-6/26W / 1400 mA - 4000 K	2604.9	29 W	80	6.80
	131-9428	LED-6/12W / 700 mA - 2700 K	1223.2	14.5 W	80	6.8
	131-9460	LED-6/12W / 700 mA - 3000 K	1313.8	14.5 W	80	6.80

WE-EF LIGHTING USA, LLC



410-D Keystone Drive, 15086 Warrendale, PA 15086 - Phone: +1 724 742 0030

customersupport.usa@we-ef.com - <https://we-ef.com/us>

Subject to technical changes and errors. - Generated on 10/23/2024

QLS420 LED

Surface Mounted Wall Luminaires

Light distribution	Part ID	Light source	Rated lumens	Rated input power	CRI	Weight (lb)
symmetric, narrow beam up and down [N/N] 	131-9461	LED-6/12W / 700 mA - 4000 K	1404.4	14.5 W	80	6.80
	131-9887	LED-6/18W / 1050 mA - 2700 K	1857.4	21 W	80	6.80
	131-9889	LED-6/26W / 1400 mA - 2700 K	2355.8	29 W	80	6.80
	131-9433	LED-2x6/24W / 700 mA - 2700 K	2447.1	27 W	80	6.8
	131-9453	LED-2x6/24W / 700 mA - 3000 K	2628.4	27 W	80	6.80
	131-9454	LED-2x6/24W / 700 mA - 4000 K	2809.6	27 W	80	6.80
	131-9758	LED-2x6/36W / 1050 mA - 3000 K	3897.2	41 W	80	6.80
	131-9763	LED-2x6/36W / 1050 mA - 4000 K	4078.5	41 W	80	6.80
	131-9768	LED-2x6/52W / 1400mA - 3000 K	4984.8	55 W	80	6.88
	131-9773	LED-2x6/52W / 1400mA - 4000 K	5211.4	55 W	80	6.88
symmetric, narrow beam up and medium beam down [N/M] 	131-9894	LED-2x6/36W / 1050 mA - 2700 K	3716	41 W	80	6.80
	131-9903	LED-2x6/52W / 1400 mA - 2700 K	4712.9	55 W	80	6.80
	131-9432	LED-2x6/24W / 700 mA - 2700 K	2315.8	27 W	80	6.8
	131-9757	LED-2x6/36W / 1050 mA - 3000 K	3688.1	41 W	80	6.80
	131-9762	LED-2x6/36W / 1050 mA - 4000 K	3859.6	41 W	80	6.80
	131-9767	LED-2x6/52W / 1400mA - 3000 K	4717.3	55 W	80	6.88
	131-9772	LED-2x6/52W / 1400mA - 4000 K	4931.7	55 W	80	6.88
symmetric, narrow beam up and side-throw down [N/S] 	131-9893	LED-2x6/36W / 1050 mA - 2700 K	3516.5	41 W	80	6.80
	131-9902	LED-2x6/52W / 1400 mA - 2700 K	4460	55 W	80	6.80
	131-7042	LED-2x6/36W / 1050 mA - 2700 K	3423.7	41 W	80	6.8
	131-7045	LED-2x6/52W / 1400 mA - 2700 K	4342.3	55 W	80	6.8
	131-9430	LED-2x6/24W / 700 mA - 2700 K	2254.7	27 W	80	6.8
	131-9445	LED-2x6/24W / 700 mA - 3000 K	2421.7	27 W	80	6.80
131-9450	LED-2x6/24W / 700 mA - 4000 K	2588.7	27 W	80	6.80	

WE-EF LIGHTING USA, LLC

410-D Keystone Drive, 15086 Warrendale, PA 15086 - Phone: +1 724 742 0030

customersupport.usa@we-ef.com - <https://we-ef.com/us>

Subject to technical changes and errors. - Generated on 10/23/2024

QLS420 LED



Surface Mounted Wall Luminaires

Electrical Accessories

Emergency Lighting Package

Description	Part ID	Additional information
_LS420/430 LED Emergency Lighting Package	131-6900	Emergency battery backup operating for a minimum 90 minutes when power is lost.

WE-EF LIGHTING USA, LLC

410-D Keystone Drive, 15086 Warrendale, PA 15086 - Phone: +1 724 742 0030
customersupport.usa@we-ef.com - <https://we-ef.com/us>
Subject to technical changes and errors. - Generated on 10/23/2024

QLS420 LED



Surface Mounted Wall Luminaires

Mounting Accessories

Surface Collar

Description	Part ID	A	B	C1	D1	D2	D3	M1	M2
QLS420 Surface Collar	131-6001	9.08	9.08	1.75	∅1	∅2	∅0.38	7.58	7.58

WE-EF LIGHTING USA, LLC

410-D Keystone Drive, 15086 Warrendale, PA 15086 - Phone: +1 724 742 0030
customersupport.usa@we-ef.com - <https://we-ef.com/us>
Subject to technical changes and errors. - Generated on 10/23/2024

QLS420 LED
Surface Mounted Wall Luminaires

WE-EF LIGHTING USA, LLC

410-D Keystone Drive, 15086 Warrendale, PA 15086
Phone: +1 724 742 0030

customersupport.usa@we-ef.com
<https://we-ef.com/us>

Subject to technical changes and errors.
Generated on 10/23/2024