

TRO259 LED

Wall luminaires recessed

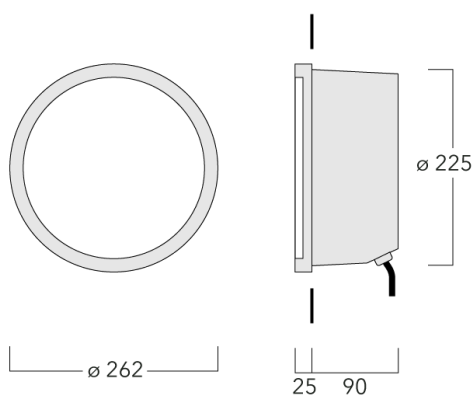

Description

IP55, Class I. Class II on request. IK10. Marine-grade, die-cast aluminium alloy. 5CE superior corrosion protection including PCS hardware. Silicone rubber gasket. Polycarbonate main lens. Two cable entries. Factory installed LED circuit board. Integral EC electronic converter.

A pre-installation blockout is available and recommended for mounting in concrete walls. To be ordered separately.





WE-EF LEUCHTEN GmbH

Töpinger Straße 16, 29646 Bispingen, Germany - Phone: +49 5194 909-0
info@we-ef.com - <https://we-ef.com>

Subject to technical changes and errors. - Generated on 23/11/2024

Specifications

Material description

Body	Marine-grade die-cast aluminium alloy
Lens	Polycarbonate lens
Colours	 RAL9004 Signal black  RAL9006 White aluminium  RAL9007 Grey aluminium  RAL7016 Anthracite grey  RAL9016 Traffic white
Gasket	Silicone rubber gasket
Fasteners	PCS Polymer Coated Stainless Steel Hardware
Ingress protection	IP55
Impact resistance	IK10
Corrosion resistance	5CE

Electrical description

Power supply	220-240V / 50-60 Hz
Driver / Ballast	Integral EC electronic converter
Surge protection	1/2 kV

Additional information

Lifetime	Ta=25° L80B10 > 54000h
Energy efficiency class	D-E (Light source)

TRO259 LED

Wall luminaires recessed

Options

Light distribution



diffused distribution

Colour temperature



3000 K



4000 K



2700 K

Nominal Watt

15 W

TRO259 LED

Wall luminaires recessed

Configurations

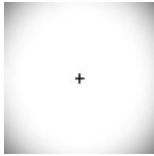
Light distribution	Part ID	Light source	Rated lumens	Rated input power	CRI	Weight (kg)
diffused distribution 	195-0890	LED-FT-17W / 500 mA - 2700 K	1346.8	20 W	80	2.10
	195-9146	LED-FT-17W / 500 mA - 3000 K	1408.7	20 W	80	2.10
	195-9147	LED-FT-17W / 500 mA - 4000 K	1468.4	20 W	80	2.10

Mounting Accessories

Installation blackout

Description	Part ID	C1	D1	C
Installation blackout BTR25-I	195-0191	125	ø 268	125

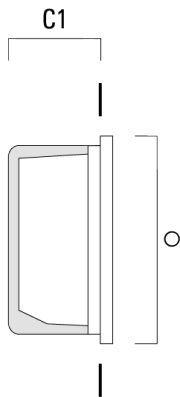

Installation blackout BTR25-II	195-0193	150	ø 268	150
--------------------------------	----------	-----	-------	-----

