

TRO259 LED

Recessed Wall Luminaires

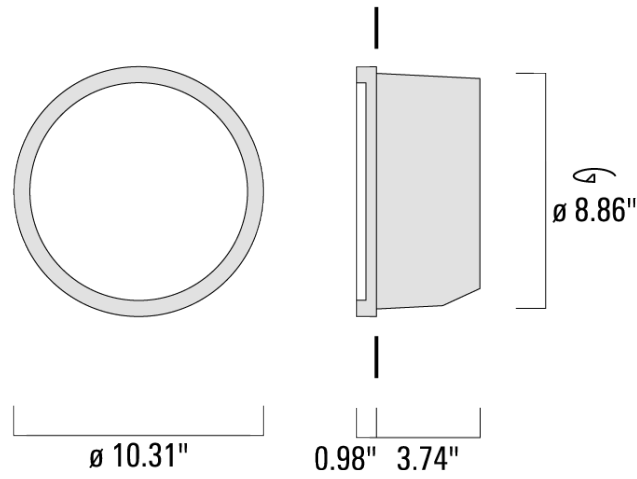

WE-EF LIGHTING USA, LLC

410-D Keystone Drive, 15086 Warrendale, PA 15086 - Phone: +1 724 742 0030
customersupport.usa@we-ef.com - <https://we-ef.com/us>
Subject to technical changes and errors. - Generated on 11/23/2024

TRO259 LED

Recessed Wall Luminaires

we-ef

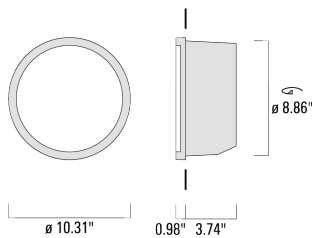

Description

Circular recessed wall luminaire. ADA (American Disabilities Act) Compliant.

IP55. Class I. IK10. Marine-grade, die-cast aluminum alloy. 5CE superior corrosion protection including PCS hardware. Silicone CCG® Controlled Compression Gasket. Polycarbonate main lens. Two cable entries. Integral driver. Factory-installed LED circuit board. 0-10V Dimming comes standard with luminaire.

A pre-installation blockout is available and recommended for mounting in concrete walls; to be ordered separately.

Specify product with 7 Digit product code - Finish Color. Accessories, such as mounting, optical, and electrical, must be specified separately.

Example: XXX-XXXX-9004 (Black)
+ XXX-XXXX (Accessory 1)

WE-EF LIGHTING USA, LLC





410-D Keystone Drive, 15086 Warrendale, PA 15086 - Phone: +1 724 742 0030
customersupport.usa@we-ef.com - <https://we-ef.com/us>

Subject to technical changes and errors. - Generated on 11/23/2024

Recessed Wall Luminaires

Specifications

Material description

Body	Luminaire body and lens frame constructed in die cast aluminum.
Lens	Opal polycarbonate lens.
Colors	 RAL9004 Black  RAL9007 Grey Metallic  RAL9016 White  RAL8019 Dark Bronze
Gasket	Silicone rubber gasket
Fasteners	PCS polymer coated stainless steel
Ingress protection	IP55
Impact resistance	IK10
Corrosion resistance	5CE

Electrical description

Power supply	Integral [ECG] electronic driver 120V-277V. 0-10V dimmable, to be specified with order.
Driver / Ballast	Integral EC electronic converter

Additional information

Lifetime	Ta=25°/40° L80B10 > 54000h
Listings	Contact WE-EF USA for ETL/UL certification status.

TRO259 LED

Recessed Wall Luminaires

we-ef

Options

Light distribution Color temperature Nominal Watt

WE-EF LIGHTING USA, LLC

410-D Keystone Drive, 15086 Warrendale, PA 15086 - Phone: +1 724 742 0030
customersupport.usa@we-ef.com - <https://we-ef.com/us>
Subject to technical changes and errors. - Generated on 11/23/2024

TRO259 LED

Recessed Wall Luminaires



Configurations

Light distribution	Part ID	Light source	Rated lumens	Rated input power	CRI	Weight (lb)
--------------------	---------	--------------	--------------	-------------------	-----	-------------

WE-EF LIGHTING USA, LLC

410-D Keystone Drive, 15086 Warrendale, PA 15086 - Phone: +1 724 742 0030
customersupport.usa@we-ef.com - <https://we-ef.com/us>
Subject to technical changes and errors. - Generated on 11/23/2024

TRO259 LED

Recessed Wall Luminaires

Mounting Accessories

Installation blackout

Description	Part ID	C1	C
Installation blackout BTR25-I-RE	618-9395	5.00	150

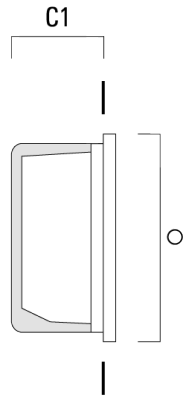

WE-EF LIGHTING USA, LLC

410-D Keystone Drive, 15086 Warrendale, PA 15086 - Phone: +1 724 742 0030
customersupport.usa@we-ef.com - <https://we-ef.com/us>
Subject to technical changes and errors. - Generated on 11/23/2024