

QRI354 LED

Wall luminaires recessed

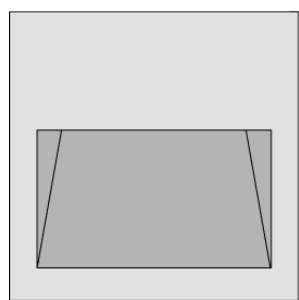

□ 262

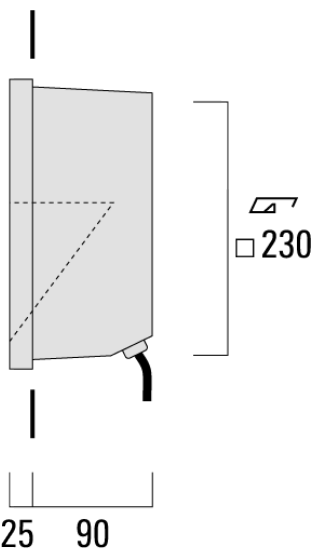





Description

IP55, Class I. IK08. Marine-grade, die-cast aluminium alloy. 5CE superior corrosion protection including PCS hardware. Silicone rubber gasket. Safety glass lens. Two cable entries.

A pre-installation blackout is available and recommended for mounting in concrete walls

Wall luminaires recessed**Specifications****Material description**

Body	Marine-grade, die-cast aluminium alloy
Lens	Safety glass lens
Colours	 RAL9004 Signal black  RAL9006 White aluminium  RAL9007 Grey aluminium  RAL7016 Anthracite grey  RAL9016 Traffic white
Gasket	Silicone rubber gasket
Fasteners	PCS hardware
Ingress protection	IP55
Impact resistance	IK08
Corrosion resistance	5CE

Electrical description

Power supply	Joint silicone
Driver / Ballast	Integral EC electronic converter
Surge protection	1/2 kV

Additional information

Lifetime	LED >60,000 h Ta 25°(B10/70) Control gear >50,000 h Ta 25°
----------	--

QRI354 LED

Wall luminaires recessed

Options

Light distribution



asymmetric, forward throw [A60]

Colour temperature



3000 K



4000 K



2700 K

Nominal Watt

0 W

QRI354 LED

Wall luminaires recessed

Configurations

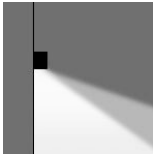
Light distribution	Part ID	Light source	Rated lumens	Rated input power	CRI	Weight (kg)
asymmetric, forward throw [A60] 	197-9084	LED-12W / 350 mA - 3000 K	511.9	15 W	80	3.40
	197-9086	LED-12W / 350 mA - 4000 K	531	15 W	80	3.40
	197-9091	LED-12W / 350 mA - 2700 K	473.6	15 W	80	3.40

Mounting Accessories

Installation blackout

Description	Part ID	A	B	C1	C
Installation blackout BQR35-I	197-0129	272	272	125	125

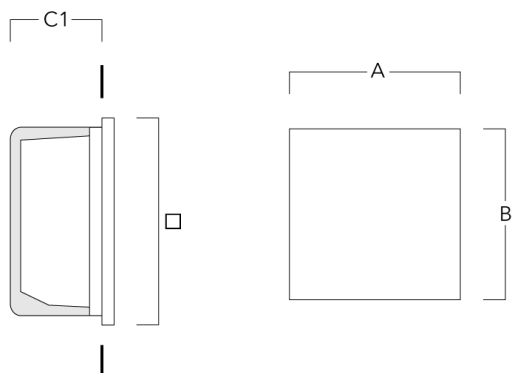

Installation blackout BQR35-II	197-0132	272	272	150	150
--------------------------------	----------	-----	-----	-----	-----

