





Description

IP55, Class I. Class II on request. IK10. Marine-grade, die-cast aluminium alloy. 5CE superior corrosion protection including PCS hardware. Silicone rubber gasket. Polycarbonate main lens. Two cable entries. Factory installed LED circuit board. Integral EC electronic converter. Optional 2200 K version available. To be specified at time of ordering.

A pre-installation blackout is available and recommended for mounting in concrete walls. To be ordered separately.

Wall luminaires recessed**Specifications****Material description**

Body	Marine-grade die-cast aluminium alloy
Lens	Polycarbonate lens
Colours	 RAL9004 Signal black  RAL9006 White aluminium  RAL9007 Grey aluminium  RAL7016 Anthracite grey  RAL9016 Traffic white
Gasket	Silicone rubber gasket
Fasteners	PCS Polymer Coated Stainless Steel Hardware
Ingress protection	IP55
Impact resistance	IK10
Corrosion resistance	5CE

Electrical description

Power supply	220-240V / 50-60 Hz
Driver / Ballast	Integral EC electronic converter
Surge protection	1/2 kV

Additional information

Lifetime	Ta=25° L80B10 > 54000h
Energy efficiency class	C-D (Light source)

SVO259 LED

Wall luminaires recessed

Options

Light distribution



diffused distribution

Colour temperature



3000 K



4000 K



2700 K

Nominal Watt

1 W

SVO259 LED

Wall luminaires recessed

Configurations

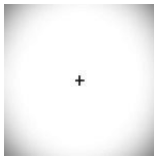
Light distribution	Part ID	Light source	Rated lumens	Rated input power	CRI	Weight (kg)
diffused distribution 	133-0323	LED-6/6W / 350 mA - 3000 K	219.3	7.5 W	80	1.10
	133-0325	LED-6/6W / 350 mA - 4000 K	240.5	7.5 W	80	1.10
	133-0440	LED-6/6W / 350 mA - 2700 K	205.2	7.5 W	80	1.10

Mounting Accessories

Installation blackout

Description	Part ID	A	B	C1
Installation blackout BST25-II	133-0078	267	132	140

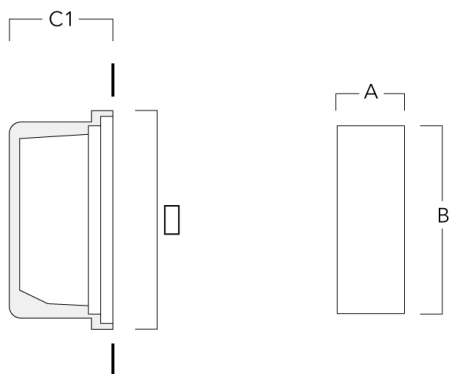

Installation blackout BST25-I	133-0076	267	132	130
-------------------------------	----------	-----	-----	-----

