



Description

IP66. Class I. IK07. Marine-grade, die-cast aluminum alloy. 5CE superior corrosion protection including PCS hardware. Silicone CCG® Controlled Compression Gasket. Safety glass lens. Includes 1 ft of flexible cable enclosed in a stainless conduit, in-line connector and mounting clamp for installation to RAIL66 mounting system. CAD-optimized optics for superior illumination and glare control. Integral driver in thermally separated compartment. OLC® One LED Concept. Factory-installed LED circuit board. 0-10V Dimming comes standard with luminaire.

Specify product with 7 Digit product code - Finish Color. Accessories, such as mounting, optical, and electrical, must be specified separately.



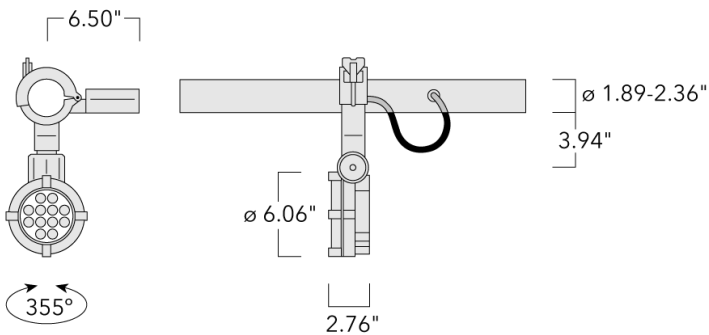

Example: XXX-XXXX-9004 (Black)
+ XXX-XXXX (Accessory 1)



RAIL66

Specifications

Material description

Body	Marine-grade die-cast aluminum alloy
Lens	Clear tempered glass lens
Colors	 RAL9004 Black  RAL9007 Grey Metallic  RAL9016 White  RAL8019 Dark Bronze
Gasket	Silicone rubber gasket
Fasteners	PCS Polymer Coated Stainless Steel hardware
Ingress protection	IP66
Impact resistance	IK07
Corrosion resistance	5CE

Electrical description

Power supply	Integral [ECG] electronic driver 120V-277V. 0-10V dimmable, to be specified with order.
Driver / Ballast	Integral EC electronic converter in thermally-separated compartment

Additional information

Lifetime	Ta=25°/40° L90B10 > 90000h
Listings	ETL listed. Suitable for wet locations.

WE-EF LIGHTING USA, LLC

410-D Keystone Drive, 15086 Warrendale, PA 15086 - Phone: +1 724 742 0030

customersupport.usa@we-ef.com - <https://we-ef.com/us>

Subject to technical changes and errors. - Generated on 10/23/2024

FLC131 LED RAIL66

RAIL66

Options

Light distribution



symmetric, medium beam [M]



symmetric, very narrow beam, 'sharp cut-off' [VNS]



linear spread, very narrow beam, 'sharp cut-off'



symmetric, wide beam [W]



symmetric, very narrow beam [VN]



linear spread, very narrow beam [VN]



wallwash [A20]

Color temperature



3000 K

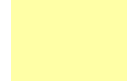

4000 K



2700 K

Nominal Watt

3 W



WE-EF LIGHTING USA, LLC

410-D Keystone Drive, 15086 Warrendale, PA 15086 - Phone: +1 724 742 0030

customersupport.usa@we-ef.com - <https://we-ef.com/us>

Subject to technical changes and errors. - Generated on 10/23/2024

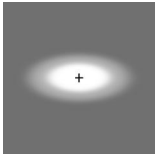
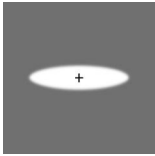
Configurations

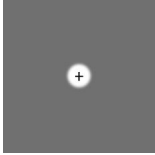
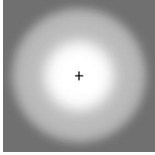
Light distribution	Part ID	Light source	Rated lumens	Rated input power	CRI	Weight (lb)
linear spread, very narrow beam [VN] 	146-0533+146-0418	LED-12/24W / 700 mA - 3000 K	2744.2	27 W	80	6.80
	146-0534+146-0418	LED-12/24W / 700 mA - 4000 K	2933.4	27 W	80	6.80
	146-0982+146-0418	LED-12/24W / 700 mA - 2700 K	2554.9	27 W	80	6.80
linear spread, very narrow beam, 'sharp cut-off' 	146-0414+146-0418	LED-12/24W / 700 mA - 3000 K	2865.9	27 W	80	6.80
	146-0415+146-0418	LED-12/24W / 700 mA - 4000 K	3063.5	27 W	80	6.80
	146-0983+146-0418	LED-12/24W / 700 mA - 2700 K	2668.2	27 W	80	6.80
symmetric, medium beam [M] 	146-0411	LED-12/24W / 700 mA - 3000 K	2998.6	27 W	80	6.80
	146-0412	LED-12/24W / 700 mA - 4000 K	3205.4	27 W	80	6.80
	146-0981	LED-12/24W / 700 mA - 2700 K	2791.8	27 W	80	6.80
symmetric, very narrow beam [VN] 	146-0533	LED-12/24W / 700 mA - 3000 K	2883.7	27 W	80	6.80
	146-0534	LED-12/24W / 700 mA - 4000 K	3082.5	27 W	80	6.80
	146-0982	LED-12/24W / 700 mA - 2700 K	2684.8	27 W	80	6.80
symmetric, very narrow beam, 'sharp cut-off' [VNS] 	146-0414	LED-12/24W / 700 mA - 3000 K	3077.9	27 W	80	6.80
	146-0415	LED-12/24W / 700 mA - 4000 K	3290.2	27 W	80	6.80
	146-0983	LED-12/24W / 700 mA - 2700 K	2865.6	27 W	80	6.80
symmetric, wide beam [W] 	146-0530	LED-12/24W / 700 mA - 3000 K	2709.2	27 W	80	6.80
	146-0531	LED-12/24W / 700 mA - 4000 K	2896	27 W	80	6.80
	146-0980	LED-12/24W / 700 mA - 2700 K	2522.3	27 W	80	6.80
wallwash [A20] 	146-0411+146-0645	LED-12/24W / 700 mA - 3000 K	2405.6	27 W	80	6.80
	146-0412+146-0645	LED-12/24W / 700 mA - 4000 K	2571.5	27 W	80	6.80
	146-0981+146-0645	LED-12/24W / 700 mA - 2700 K	2239.7	27 W	80	6.80

WE-EF LIGHTING USA, LLC

410-D Keystone Drive, 15086 Warrendale, PA 15086 - Phone: +1 724 742 0030

customersupport.usa@we-ef.com - <https://we-ef.com/us>

Subject to technical changes and errors. - Generated on 10/23/2024

FLC131 LED RAIL66

RAIL66

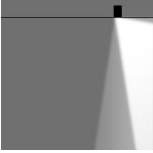
Light distribution	Part ID	Light source	Rated lumens	Rated input power	CRI	Weight (lb)
						

WE-EF LIGHTING USA, LLC

410-D Keystone Drive, 15086 Warrendale, PA 15086 - Phone: +1 724 742 0030
customersupport.usa@we-ef.com - <https://we-ef.com/us>
Subject to technical changes and errors. - Generated on 10/23/2024

Optical Accessories

Glare shield

Description	Part ID	A	C1
Glare shield ES	146-0156	4.33	3.94

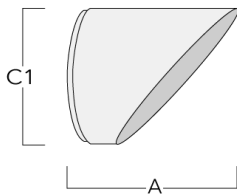

Snoot

RAIL66

Description	Part ID	A	C1
Snoot ET	146-0397	3.76	4.96

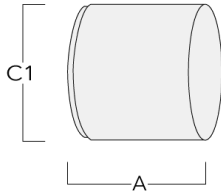

Softening Lens

Description	Part ID	C1
IO-360	146-0623	4.33"

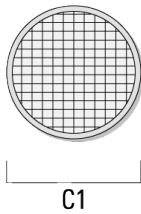

Linear spread lens

WE-EF LIGHTING USA, LLC

410-D Keystone Drive, 15086 Warrendale, PA 15086 - Phone: +1 724 742 0030

customersupport.usa@we-ef.com - <https://we-ef.com/us>

Subject to technical changes and errors. - Generated on 10/23/2024

FLC131 LED RAIL66

RAIL66

Description	Part ID	C1
IO-180-FLC131-LED	146-0418	4.30

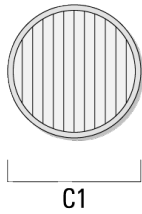

Wallwash lens

Description	Part ID	C1
IO-20-WW-FLC131-LED	146-0645	4.33

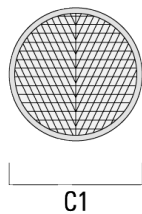

Honeycomb louvre

WE-EF LIGHTING USA, LLC

410-D Keystone Drive, 15086 Warrendale, PA 15086 - Phone: +1 724 742 0030

customersupport.usa@we-ef.com - <https://we-ef.com/us>

Subject to technical changes and errors. - Generated on 10/23/2024

FLC131 LED RAIL66

RAIL66

Description	Part ID	C1
IW-FLC131-LED	146-0625	4.33

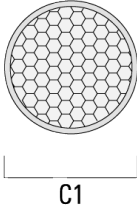

WE-EF LIGHTING USA, LLC

410-D Keystone Drive, 15086 Warrendale, PA 15086 - Phone: +1 724 742 0030

customersupport.usa@we-ef.com - <https://we-ef.com/us>

Subject to technical changes and errors. - Generated on 10/23/2024

Mounting Accessories

Universal

Description	Part ID	C1	C2	H1	M1	Weight (lb)	L1	L2
2 Mains outlets (L=45.28)	310-9200	3.00	1.20	7.90	0.5	13.00	45.28	41.14

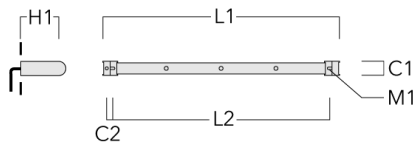

3 Mains outlets (L=45.28)	310-9202	3.00	1.20	7.90	0.5	13.00	45.28	41.14
---------------------------	----------	------	------	------	-----	-------	-------	-------

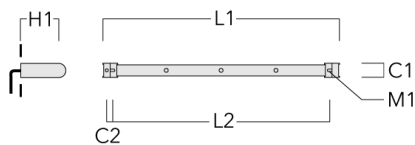

FLC131 LED RAIL66

RAIL66

Description	Part ID	C1	C2	H1	M1	Weight (lb)	L1	L2
3 Mains outlets (L=64.69)	310-9210	3.00	1.18	7.90	0.5	15.90	64.69	60.83

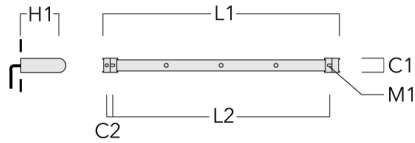

4 Mains outlets (L=64.69)	310-9212	3.00	1.18	7.90	5	13.00 lbs	64.69	60.83
---------------------------	----------	------	------	------	---	-----------	-------	-------

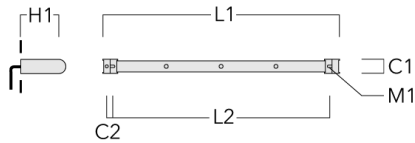

WE-EF LIGHTING USA, LLC

410-D Keystone Drive, 15086 Warrendale, PA 15086 - Phone: +1 724 742 0030

customersupport.usa@we-ef.com - <https://we-ef.com/us>

Subject to technical changes and errors. - Generated on 10/23/2024

RAIL66

Description	Part ID	C1	C2	H1	M1	Weight (lb)	L1	L2
4 Mains outlets (L=84.65)	310-9220	3.00	1.18	7.90	0.5	18.76	84.65	80.51

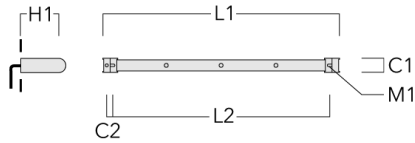

6 Mains outlets (L=84.65)	310-9222	3.00	1.18	7.90	0.5	18.76	84.65	80.51
---------------------------	----------	------	------	------	-----	-------	-------	-------

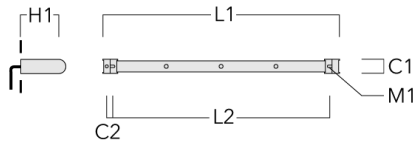

Flat Surface Fitters

WE-EF LIGHTING USA, LLC

410-D Keystone Drive, 15086 Warrendale, PA 15086 - Phone: +1 724 742 0030

customersupport.usa@we-ef.com - <https://we-ef.com/us>

Subject to technical changes and errors. - Generated on 10/23/2024

RAIL66

Description	Part ID	C1	C2	D1	D2	L	M1	Weight (lb)
Surface fitters (pair)	310-9290	0.79	1.18	7.1	5.5	42.1	.35	3.70

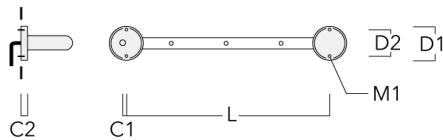

Column Fitters

Description	Part ID	C1	C2	L	M1	Weight (lb)
Column Fitters (pair)	310-9294	1.20	4.00	43.9	.5	2.00

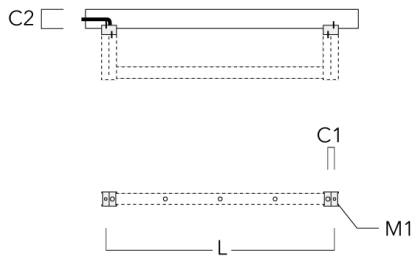

Cantilever

WE-EF LIGHTING USA, LLC

410-D Keystone Drive, 15086 Warrendale, PA 15086 - Phone: +1 724 742 0030

customersupport.usa@we-ef.com - <https://we-ef.com/us>

Subject to technical changes and errors. - Generated on 10/23/2024

RAIL66

Description	Part ID	C1	C2	C3	H1	M1	Weight (lb)	L1	L2
2 Mains outlets (L=45.28)	310-9230	8.66	4.72	2.36	23.62	0.51	26.46	45.28	42.13

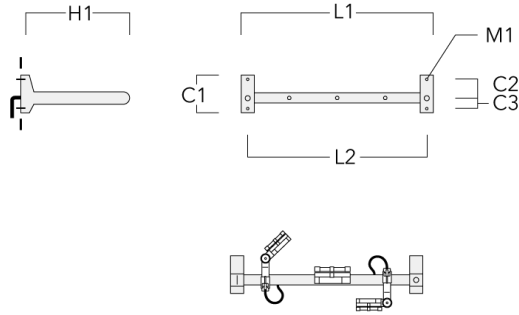

3 Mains outlets (L=45.28)	310-9232	8.66	4.72	2.36	23.62	0.51	26.46	45.28	42.13
---------------------------	----------	------	------	------	-------	------	-------	-------	-------

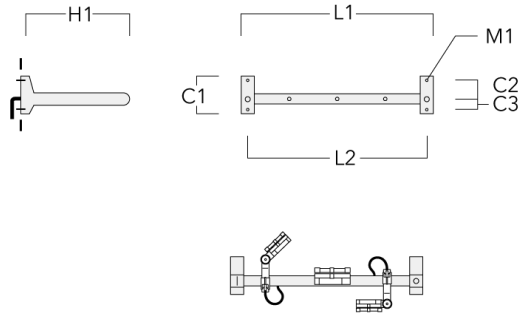

WE-EF LIGHTING USA, LLC

410-D Keystone Drive, 15086 Warrendale, PA 15086 - Phone: +1 724 742 0030

customersupport.usa@we-ef.com - <https://we-ef.com/us>

Subject to technical changes and errors. - Generated on 10/23/2024

FLC131 LED RAIL66

RAIL66

Description	Part ID	C1	C2	C3	H1	M1	Weight (lb)	L1	L2
3 Mains outlets (L=64.69)	310-9240	8.66	4.72	2.36	23.62	0.51	29.32	64.96	61.81

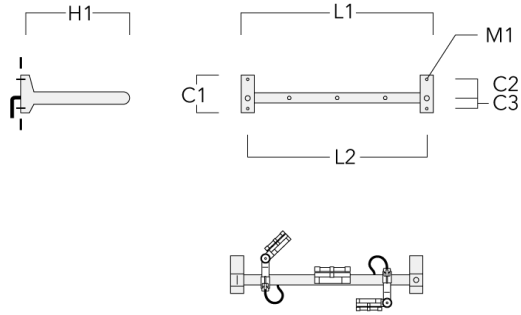

4 Mains outlets (L=64.69)	310-9242	8.66	4.72	2.36	23.62	0.51	29.32	64.96	61.81
---------------------------	----------	------	------	------	-------	------	-------	-------	-------

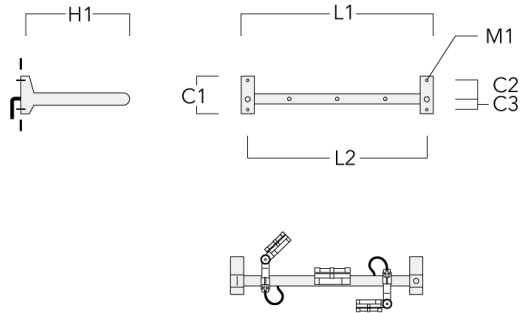

WE-EF LIGHTING USA, LLC

410-D Keystone Drive, 15086 Warrendale, PA 15086 - Phone: +1 724 742 0030

customersupport.usa@we-ef.com - <https://we-ef.com/us>

Subject to technical changes and errors. - Generated on 10/23/2024

RAIL66

Description	Part ID	C1	C2	C3	H1	M1	Weight (lb)	L1	L2
4 Mains outlets (L=84.65)	310-9250	8.66	4.72	2.36	23.62	0.51	32.19	84.65	81.49

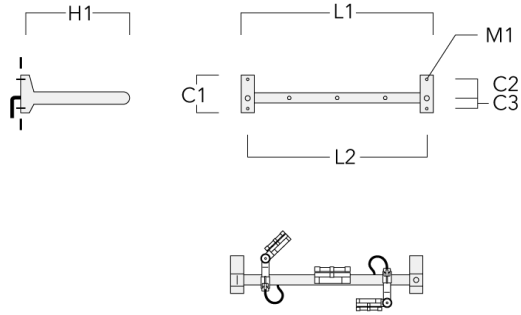

6 Mains outlets (L=84.65)	310-9252	8.66	4.72	2.36	23.62	0.51	32.19	84.65	81.5
---------------------------	----------	------	------	------	-------	------	-------	-------	------

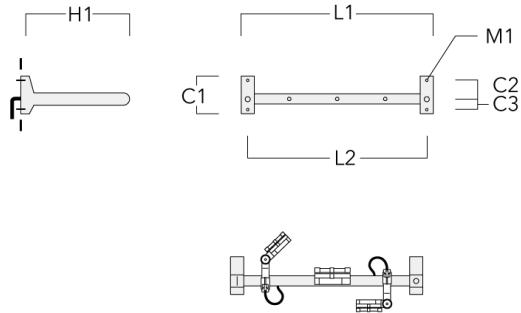

WE-EF LIGHTING USA, LLC

410-D Keystone Drive, 15086 Warrendale, PA 15086 - Phone: +1 724 742 0030

customersupport.usa@we-ef.com - <https://we-ef.com/us>

Subject to technical changes and errors. - Generated on 10/23/2024

FLC131 LED RAIL66

RAIL66

WE-EF LIGHTING USA, LLC

410-D Keystone Drive, 15086 Warrendale, PA 15086

Phone: +1 724 742 0030

customersupport.usa@we-ef.com

<https://we-ef.com/us>

Subject to technical changes and errors.

Generated on 10/23/2024