



Description



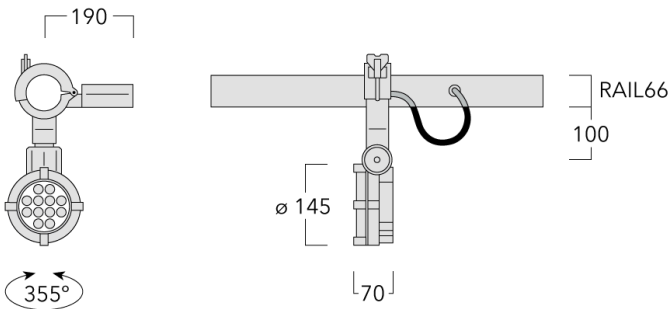

IP66, Class I. IK07. Marine-grade, die-cast aluminium alloy. 5CE superior corrosion protection including PCS hardware. Safety glass lens. Silicone CCG® Controlled Compression Gasket. Luminaire is factory-sealed and does not need to be opened during installation.

Integral EC electronic converter in thermally-separated compartment. Advanced thermal management protects LEDs while optimising lumens output. CAD-optimised optics for superior illumination and glare control. OLC® One LED Concept.

Including 0.4 m of flexible cable enclosed in a stainless conduit, in-line connector and mounting clamp for installation to RAIL66 mounting system.



Specifications**Material description**

Body	Marine-grade, die-cast aluminium alloy
Lens	Safety glass lens
Colours	 RAL9004 Signal black  RAL9007 Grey aluminium  RAL7016 Anthracite grey  RAL9016 Traffic white
Gasket	Silicone CCG® Controlled Compression Gasket
Fasteners	PCS hardware
Ingress protection	IP66
Impact resistance	IK07
Corrosion resistance	5CE

Electrical description

Power supply	220-240V / 50-60 Hz
Driver / Ballast	Integral EC electronic converter in thermally-separated compartment

Additional information

Lifetime	Ta=25° L90B10 > 90000h
----------	------------------------

FLC131 LED RAIL66

RAIL66

we-ef

Options

Light distribution



symmetric, medium beam [M]



symmetric, very narrow beam, sharp cut-off [EES]



linear spread, very narrow beam, sharp cut-off [EES]



symmetric, wide beam [B]



symmetric, very narrow beam [EE]



linear spread, very narrow beam [EE]



wallwash

Colour temperature



3000 K



4000 K

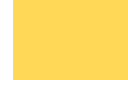





2700 K

Nominal Watt

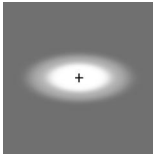
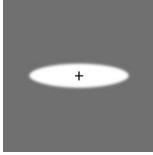
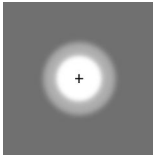
3 W

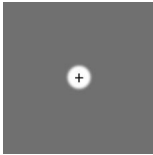
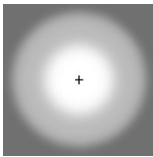
Configurations

Light distribution	Part ID	Light source	Rated lumens	Rated input power	CRI	Weight (kg)
linear spread, very narrow beam [EE] 	146-0533+146-0418	LED-12/24W / 700 mA - 3000 K	2744.2	27 W	80	3.10
	146-0534+146-0418	LED-12/24W / 700 mA - 4000 K	2933.4	27 W	80	3.10
	146-0982+146-0418	LED-12/24W / 700 mA - 2700 K	2554.9	27 W	80	3.10
linear spread, very narrow beam, sharp cut-off [EES] 	146-0414+146-0418	LED-12/24W / 700 mA - 3000 K	2865.9	27 W	80	3.10
	146-0415+146-0418	LED-12/24W / 700 mA - 4000 K	3063.5	27 W	80	3.10
	146-0983+146-0418	LED-12/24W / 700 mA - 2700 K	2668.2	27 W	80	3.10
symmetric, medium beam [M] 	146-0411	LED-12/24W / 700 mA - 3000 K	2998.6	27 W	80	3.10
	146-0412	LED-12/24W / 700 mA - 4000 K	3205.4	27 W	80	3.10
	146-0981	LED-12/24W / 700 mA - 2700 K	2791.8	27 W	80	3.10
symmetric, very narrow beam [EE] 	146-0533	LED-12/24W / 700 mA - 3000 K	2883.7	27 W	80	3.10
	146-0534	LED-12/24W / 700 mA - 4000 K	3082.5	27 W	80	3.10
	146-0982	LED-12/24W / 700 mA - 2700 K	2684.8	27 W	80	3.10
symmetric, very narrow beam, sharp cut-off [EES] 	146-0414	LED-12/24W / 700 mA - 3000 K	3077.9	27 W	80	3.10
	146-0415	LED-12/24W / 700 mA - 4000 K	3290.2	27 W	80	3.10
	146-0983	LED-12/24W / 700 mA - 2700 K	2865.6	27 W	80	3.10
symmetric, wide beam [B] 	146-0530	LED-12/24W / 700 mA - 3000 K	2709.2	27 W	80	3.10
	146-0531	LED-12/24W / 700 mA - 4000 K	2896	27 W	80	3.10
	146-0980	LED-12/24W / 700 mA - 2700 K	2522.3	27 W	80	3.10
wallwash 	146-0411+146-0645	LED-12/24W / 700 mA - 3000 K	2405.6	27 W	80	3.10
	146-0412+146-0645	LED-12/24W / 700 mA - 4000 K	2571.5	27 W	80	3.10
	146-0981+146-0645	LED-12/24W / 700 mA - 2700 K	2239.7	27 W	80	3.10

Optical Accessories

Glare shield

Description	Part ID	A	C1
Glare shield ES	146-0156	110	100

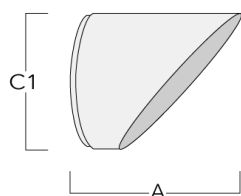

Snoot

Description	Part ID	A	C1
Snoot ET	146-0397	95,5	126

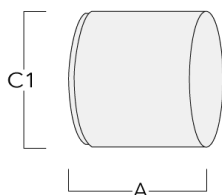

RAIL66**Flood lens**

Description	Part ID	C1
Flood lens IO-360	146-0419	110

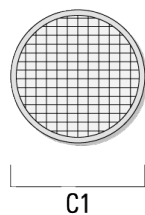
**Linear louvre**

Description	Part ID	C1
Linear louvre IL	146-9055	110



RAIL66**Linear spread lens**

Description	Part ID	C1
Linear spread lens IO-180	146-0418	110

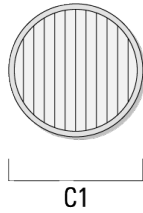
**Wallwash lens**

Description	Part ID	C1
Wallwash lens IO-20	146-0645	110

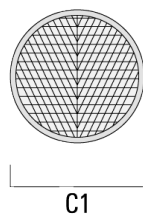

RAIL66**Honeycomb louvre**

Description	Part ID	C1
Honeycomb louvre IW	146-0625	110

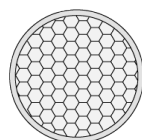

C1

Colour correction filter

Description	Part ID
IF-3000K > 2400K	146-9054

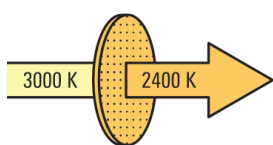

Mounting Accessories

Flat Surface Fitters

Description	Part ID	C1	C2	D1	D2	L	M1	Weight (kg)
Surface fitters (pair)	310-9290	20	30	180	140	1070	9	1.70

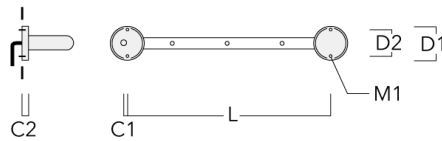

Column Fitters

Description	Part ID	C1	C2	L	M1	Weight (kg)
Column fitters (pair)	310-9294	30	100	1115	12	0.90

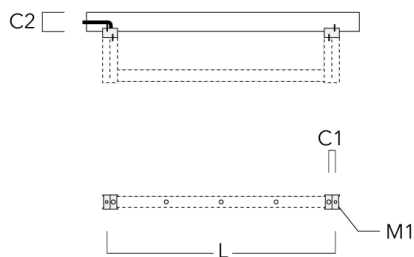

RAIL66

Universal

Description	Part ID	C1	C2	H1	M1	Weight (kg)	L1	L2
2 Mains outlets (L=1150)	310-9300	75	30	200	12	5.90	1150	1045

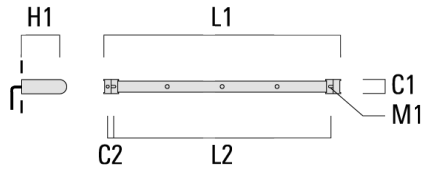

3 Mains outlets (L=1150)	310-9301	75	30	200	12	5.90	1150	1045
--------------------------	----------	----	----	-----	----	------	------	------

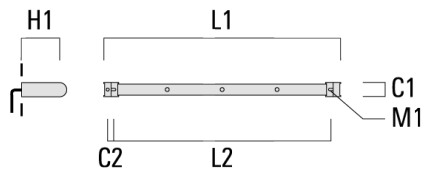

RAIL66

Description	Part ID	C1	C2	H1	M1	Weight (kg)	L1	L2
3 Mains outlets (L=1650)	310-9302	75	30	200	12	7.20	1650	1545

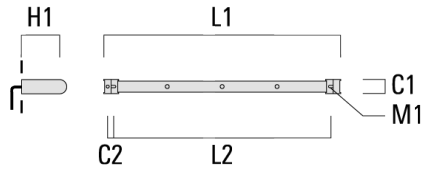

4 Mains outlets (L=1650)	310-9303	75	30	200	12	7.20	1650	1545
--------------------------	----------	----	----	-----	----	------	------	------

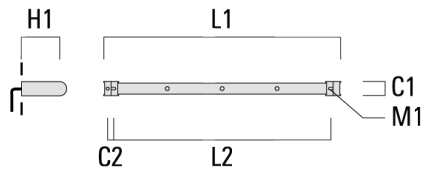

RAIL66

Description	Part ID	C1	C2	H1	M1	Weight (kg)	L1	L2
4 Mains outlets (L=2150)	310-9304	75	30	200	12	8.50	2150	2045

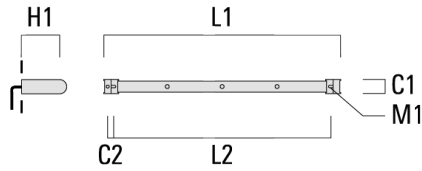

6 Mains outlets (L=2150)	310-9305	75	30	200	12	8.50	2150	2045
--------------------------	----------	----	----	-----	----	------	------	------

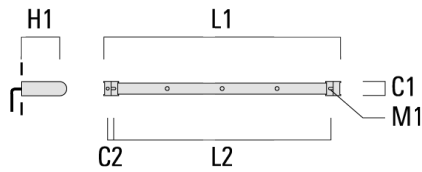

RAIL66

Cantilever

Description	Part ID	C1	C2	C3	H1	M1	Weight (kg)	L1	L2
2 Mains outlets (L=1150)	310-9233	220	120	60	600	13	12.00	1150	1070

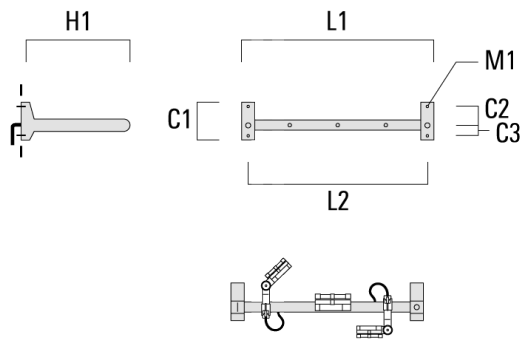

3 Mains outlets (L=1150)	310-9234	220	120	60	600	13	12.00	1150	1070
--------------------------	----------	-----	-----	----	-----	----	-------	------	------

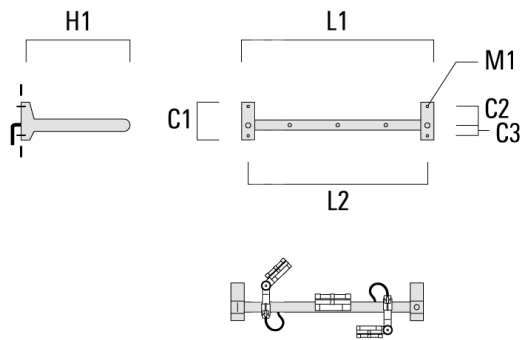

RAIL66

Description	Part ID	C1	C2	C3	H1	M1	Weight (kg)	L1	L2
3 Mains outlets (L=1650)	310-9243	220	120	60	600	13	13.30	1650	1570

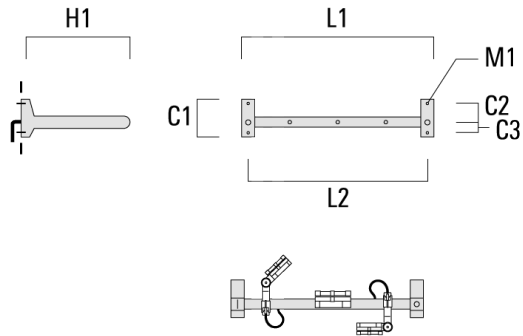

4 Mains outlets (L=1650)	310-9244	220	120	60	600	13	13.30	1650	1570
--------------------------	----------	-----	-----	----	-----	----	-------	------	------

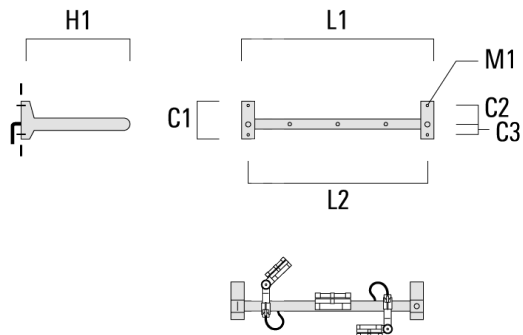

RAIL66

Description	Part ID	C1	C2	C3	H1	M1	Weight (kg)	L1	L2
4 Mains outlets (L=2150)	310-9255	220	120	60	600	13	14.60	2150	2070

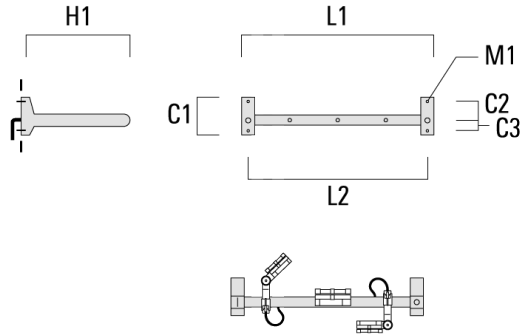

6 Mains outlets (L=2150)	310-9256	220	120	60	600	13	14.60	2150	2070
--------------------------	----------	-----	-----	----	-----	----	-------	------	------

