

**ETC140-GB LED**

**Inground luminaires**

**we-ef**



**WE-EF LEUCHTEN GmbH**

Töpinger Straße 16, 29646 Bispingen, Germany - Phone: +49 5194 909-0  
info@we-ef.com - <https://we-ef.com>

Subject to technical changes and errors. - Generated on 23/11/2024

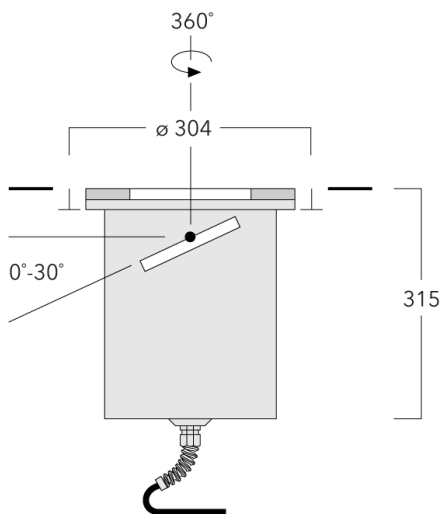

### Description

IP67\*, Class I. IK10+. Stainless steel construction including PCS hardware. Silicone rubber gasket. Safety glass lens; max. load 5 tonnes. Luminaire can be driven over at low speed. Factory-sealed termination chamber complete with cable gland and 1.5 m of flexible PVC free cable. Cable gland with spiral cable bending protection. Integral EC electronic converter in thermally separated compartment. 'No tool' removable gear/lens tray. CAD-optimised optics for superior illumination and glare control. OLC® One LED Concept. Factory installed LED circuit board. Gimbal mounted, 360° rotatable and 30° tiltable.

The optional installation blackout is recommended for mounting. To be ordered separately.

The luminaire is not suitable for permanent underwater operation and must be switched off in the event of flooding.

Optional with Anti-Slip ceramic Coating ASC to DIN 51130 (Trip Classification 10) available on request.

\* Additionally tested to IP66, IP67, IP68 0.1 bar 3h, up to 1 m depth according to DIN EN 60598 and IP69K/80° according to DIN EN 60529.

# ETC140-GB LED

## Inground luminaires

### Specifications

#### Material description

---

Body	Stainless steel construction
Lens	Safety glass lens; max. load 5 tonnes
Colours	 Stainless Steel
Gasket	Silicone rubber gasket
Fasteners	PCS Polymer Coated Stainless Steel Hardware
Ingress protection	IP67
Impact resistance	IK10+
Corrosion resistance	5CE

---

#### Electrical description

---

Power supply	220-240V / 50-60 Hz
Driver / Ballast	Integral EC electronic converter
Surge protection	6/6 kV

---

#### Additional information

---

Lifetime	Ta=25° L90B10 > 90000h
Energy efficiency class	C-D (Light source)

---

### Options

#### Light distribution



symmetric, medium beam [M]



symmetric, very narrow beam, sharp cut-off [EES]



linear spread, very narrow beam, sharp cut-off [EES]



symmetric, wide beam [B]



symmetric, very narrow beam [EE]



linear spread, very narrow beam [EE]



wallwash



asymmetric, wallgrazer [A6]

#### Colour temperature



3000 K

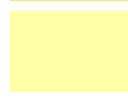

4000 K





2700 K

#### Nominal Watt

29 W

0 W

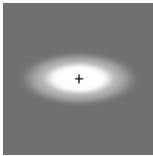
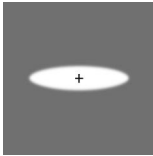
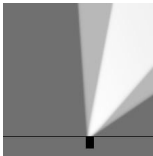
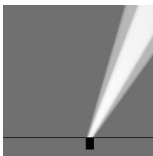
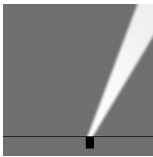
## Configurations

Light distribution	Part ID	Light source	Rated lumens	Rated input power	CRI	Weight (kg)
asymmetric, wallgrazer [A6] 	185-3750	LED-24/24W / 350 mA - 3000 K	2793.7	26.5 W	80	10.60
	185-3751	LED-24/24W / 350 mA - 4000 K	3064	26.5 W	80	10.60
	185-3757	LED-24/24W / 350 mA - 2700 K	2613.4	26.5 W	80	10.60
linear spread, very narrow beam [EE] 	185-2726+185-2719	LED-24/24W / 350 mA - 3000 K	2904.6	26.5 W	80	10.60
	185-2727+185-2719	LED-24/24W / 350 mA - 4000 K	3185.6	26.5 W	80	10.60
linear spread, very narrow beam, sharp cut-off [EES] 	185-2603+185-2719	LED-24/24W / 350 mA - 3000 K	3197.9	26.5 W	80	10.60
	185-2604+185-2719	LED-24/24W / 350 mA - 4000 K	3507.4	26.5 W	80	10.60
symmetric, medium beam [M] 	185-2600	LED-24/24W / 350 mA - 3000 K	3274.8	26.5 W	80	10.60
	185-2601	LED-24/24W / 350 mA - 4000 K	3591.7	26.5 W	80	10.60
	185-3544	LED-24/24W / 350 mA - 2700 K	3063.5	26.5 W	80	10.60
symmetric, very narrow beam [EE] 	185-2726	LED-24/24W / 350 mA - 3000 K	3200.5	26.5 W	80	10.60
	185-2727	LED-24/24W / 350 mA - 4000 K	3510.3	26.5 W	80	10.60
	185-3545	LED-24/24W / 350 mA - 2700 K	2994.1	26.5 W	80	10.60
symmetric, very narrow beam, sharp cut-off [EES] 	185-2603	LED-24/24W / 350 mA - 3000 K	3473.6	26.5 W	80	10.60
	185-2604	LED-24/24W / 350 mA - 4000 K	3809.7	26.5 W	80	10.60
	185-3546	LED-24/24W / 350 mA - 2700 K	3249.5	26.5 W	80	10.60
symmetric, wide beam [B] 	185-2723	LED-24/24W / 350 mA - 3000 K	2915	26.5 W	80	10.60
	185-2724	LED-24/24W / 350 mA - 4000 K	3197.1	26.5 W	80	10.60
	185-3543	LED-24/24W / 350 mA - 2700 K	2727	26.5 W	80	10.60
wallwash	185-3093	LED-24/24W / 350 mA - 3000 K	2521.6	26.5 W	80	10.60

# ETC140-GB LED

## Inground luminaires

Light distribution	Part ID	Light source	Rated lumens	Rated input power	CRI	Weight (kg)
	185-3094	LED-24/24W / 350 mA - 4000 K	2765.6	26.5 W	80	10.60
	185-3213	LED-24/24W / 350 mA - 2700 K	2358.9	26.5 W	80	10.60

**WE-EF LEUCHTEN GmbH**

Töpinger Straße 16, 29646 Bispingen, Germany - Phone: +49 5194 909-0  
info@we-ef.com - <https://we-ef.com>

Subject to technical changes and errors. - Generated on 23/11/2024

## Mounting Accessories

### Installation blackout

Description	Part ID	D1	D2	H1	Weight (kg)	D	H
Blockout, Plastic	185-0323	300	325	420	2.50	300/325	420

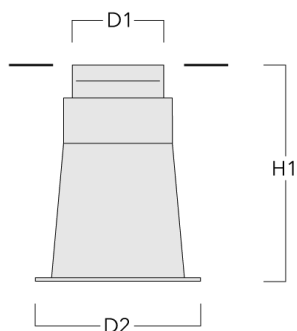

### Installation cover

Description	Part ID	C1
Installation cover BE	185-0326	300

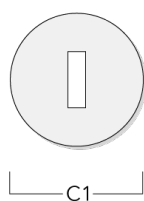

### Electrical Accessories

#### Sealable junction box

Description	Part ID	C1	M1	M2
Sealable junction box SJB130	185-1624	146	Ø 10	Ø 12 - 19

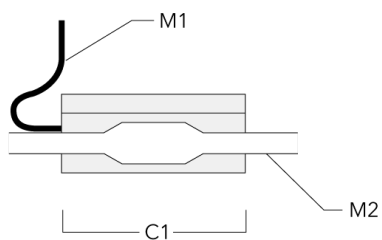



### Optical Accessories

#### Linear spread lens

Description	Part ID	C1
IO-180-6 ETC140-GB-LED	185-2719	149

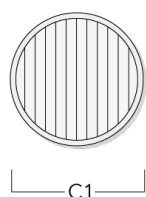

#### Flood lens

Description	Part ID	C1
Flood lens IO-360	185-2867	149

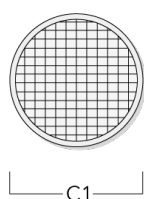

**Inground luminaires**

**Honeycomb louvre**

---

Description	Part ID	C1
Honeycomb Louvre	185-2871	149

---

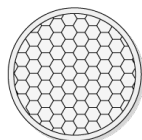

C1