

**Description**

IP66. Classe I. IK07. Corps en fonte d'aluminium. Visserie inox avec traitement PCS. Protection contre la corrosion 5CE. Joint silicone. Verre de sécurité. Lentilles LED en PMMA.

Version en 2200K disponible. À préciser lors de la demande de devis.

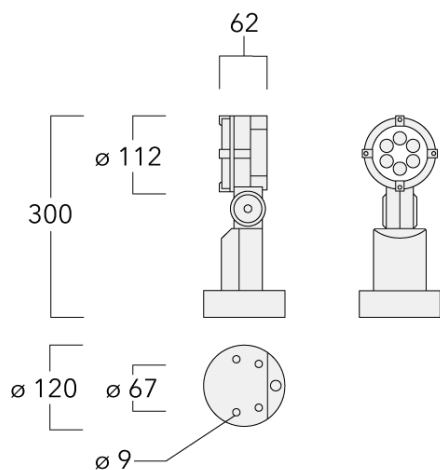

Spécifications**Description du matériel**

Corps	Corps en fonte d'aluminium, visserie inox avec traitement PCS
Lentille	Verre de sécurité
Couleurs	Peinture poudre disponible avec 35 couleurs différents
Joint	Joint silicone CCG®
Visserie	PCS Inox avec recouvrement polymère
IP	IP66
IK	IK07
Protection contre la corrosion	5CE
Surface exposée au vent	0.025 m ²

Description électrique

Alimentation électrique	220-240V / 50-60 Hz
Driver	Driver électronique séparé thermiquement

Informations complémentaires

Durée de vie	Ta=25° L90B10 > 90000h
Classe d'efficacité énergétique	C-D

Options

Types photométriques



faisceau symétrique, médium [M]



faisceau symétrique, ultra intensif, 'cut-off' [EES]



faisceau symétrique ovalisante, ultra intensif, 'cut-off'

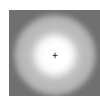

faisceau symétrique, extensif [B]



faisceau symétrique, ultra intensif [EE]

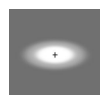

faisceau ovalisante, ultra intensif [EE]



wallwash

Température de couleur



3000 K



4000 K





2700 K

Données en sortie de luminaire

16 W

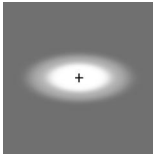
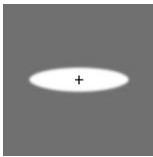
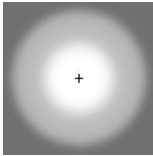
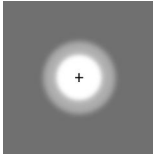
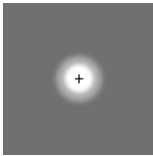
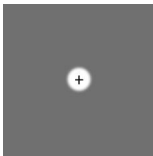
Configurations

Types photométries	Code produit	Type de Lampes	Rated lumens	Rated input power	IRC	Poids (kg)
faisceau ovalisante, ultra intensif [EE] 	145-0055+145-0050	LED-6/12W / 700 mA - 3000 K	1386.3	14.5 W	80	1.70
	145-0056+145-0050	LED-6/12W / 700 mA - 4000 K	1481.9	14.5 W	80	1.70
	145-0278+145-0050	LED-6/12W / 700 mA - 2700 K	1393.3	14.5 W	80	1.70
faisceau symétrique ovalisante, ultra intensif, 'cut-off' 	145-0034+145-0050	LED-6/12W / 700 mA - 3000 K	1526.2	14.5 W	80	1.70
	145-0035+145-0050	LED-6/12W / 700 mA - 4000 K	1631.5	14.5 W	80	1.70
	145-0292+145-0050	LED-6/12W / 700 mA - 2700 K	1499.6	14.5 W	80	1.70
faisceau symétrique, extensif [B] 	145-0052	LED-6/12W / 700 mA - 3000 K	1347.1	14.5 W	80	1.70
	145-0053	LED-6/12W / 700 mA - 4000 K	1440	14.5 W	80	1.70
	145-0284	LED-6/12W / 700 mA - 2700 K	1254.2	14.5 W	80	1.70
faisceau symétrique, médium [M] 	145-0031	LED-6/12W / 700 mA - 3000 K	1511.8	14.5 W	80	1.70
	145-0032	LED-6/12W / 700 mA - 4000 K	1616.1	14.5 W	80	1.70
	145-0283	LED-6/12W / 700 mA - 2700 K	1407.5	14.5 W	80	1.70
faisceau symétrique, ultra intensif [EE] 	145-0055	LED-6/12W / 700 mA - 3000 K	1496.5	14.5 W	80	1.70
	145-0056	LED-6/12W / 700 mA - 4000 K	1599.7	14.5 W	80	1.70
	145-0278	LED-6/12W / 700 mA - 2700 K	1393.3	14.5 W	80	1.70
faisceau symétrique, ultra intensif, 'cut-off' [EES] 	145-0034	LED-6/12W / 700 mA - 3000 K	1610.7	14.5 W	80	1.70
	145-0035	LED-6/12W / 700 mA - 4000 K	1721.8	14.5 W	80	1.70
	145-0292	LED-6/12W / 700 mA - 2700 K	1499.6	14.5 W	80	1.70
wallwash 	145-0031+145-0145	LED-6/12W / 700 mA - 3000 K	1213	14.5 W	80	1.70
	145-0032+145-0145	LED-6/12W / 700 mA - 4000 K	1296.6	14.5 W	80	1.70
	145-0283+145-0145	LED-6/12W / 700 mA - 2700 K	1407.5	14.5 W	80	1.70

Accessoires Optiques**Canon anti-éblouissement**

Description	Code produit	A	C1
Canon anti-éblouissement ET	145-0030	60	120

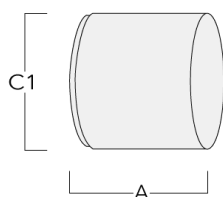
**Lentille ovalisante**

Description	Code produit	C1
IO-180-FLC121-LED	145-0050	81

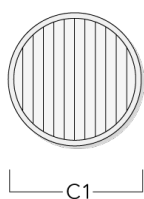

Lentille e'largissante

Description	Code produit	C1
IO-360-FLC121-LED	145-0142	81

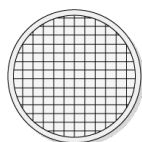

C1

Lentille rasante

Description	Code produit	C1
IO-20-WW-FLC121-LED	145-0145	81

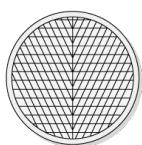

C1

WE-EF LUMIERE

ZAC de Chesnes Nord, 6 Rue de Brisson, CS80330, 38290 Satolas et Bonce - Téléphone: +33 4 74 99 14 44
info.france@we-ef.com - <https://we-ef.com/fr>

Sous réserve de modifications techniques et d'erreurs. - Généré le 23/11/2024

Visière

Description	Code produit	A	C1
Visière ES	145-9192	102	119

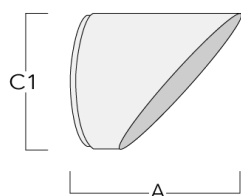

Accessoires d'installation

Collier pour tubes SP

Description	Code produit	D1	Poids (kg)	D
SP1-2/M8 collier simple (Ø 76-89)	146-0246	76-89	1.20	76-89

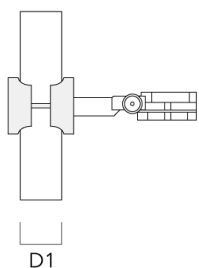

SP2-2/M8 collier double (Ø 38-60)	146-0247	38-60	1	38-66
-----------------------------------	----------	-------	---	-------

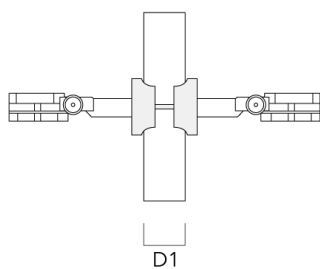

Description	Code produit	D1	Poids (kg)	D
SP2-2/M8 collier double (Ø 76-89)	146-0248	76-89	1.20	76-89

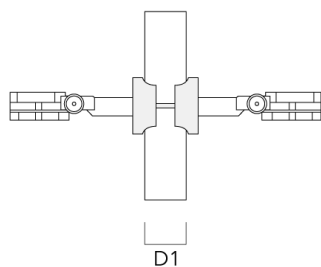

SP1-2/M8 collier simple pour tube (Ø 38-60)	146-0245	38-60	1	38-66
---	----------	-------	---	-------

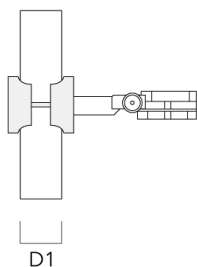

Socle de montage EM

Description	Code produit	D1	D2	H1	M1	Poids (kg)
EM1-2/M5 socle de montage en fonte d'aluminium	146-0253	160	130	200	9	1.10

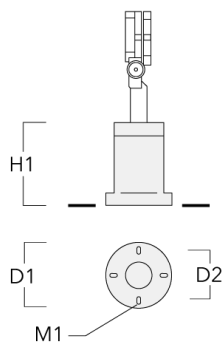

Piquet à planter EF

Description	Code produit	H1	Poids (kg)
Piquet à planter EF1-2/M5	146-0251	270	0.40

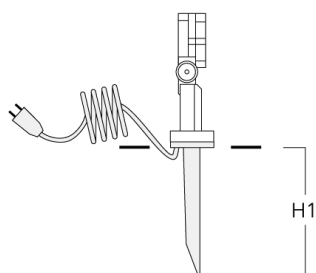

Base à enterrer

Description	Code produit	D1	D2	D3	D4	H1	H2	M1	Poids (kg)
Base à enterrer ESV4	300-0461	145	130	102	108	400	350	8	7.85

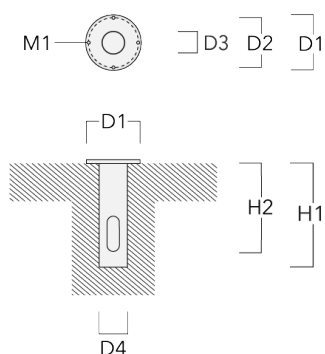

JB1 Boîte de dérivation étanche

Description	Code produit	D1	D2	M1	Poids (kg)
JB1 Junction box	310-9000	135	67	9	1.6

