

FLC121 LED - Wall bracket Floodlights

we-ef

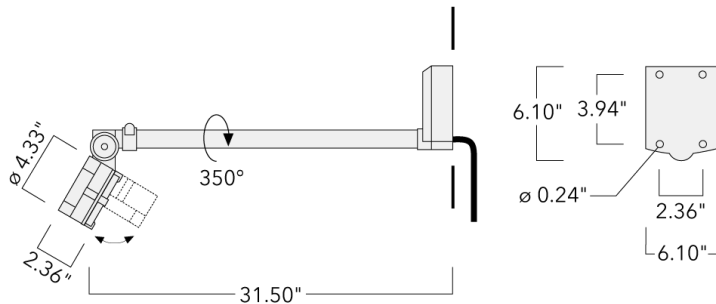

Description

IP66. Class I. IK07. Marine-grade, die-cast aluminum alloy. 5CE superior corrosion protection including PCS hardware. Silicone CCG® Controlled Compression Gasket. Safety glass lens. CAD-optimized optics for superior illumination and glare control. Integral driver in thermally separated compartment. OLC® One LED Concept. Factory-installed LED circuit board. 0-10V Dimming comes standard with luminaire.

Knuckle permits 350° horizontal and 90° vertical aiming of optics.

Specify product with 7 Digit product code - Finish Color. Accessories, such as mounting, optical, and electrical, must be specified separately.

Example: XXX-XXXX-9004 (Black).

+ XXX-XXXX (Accessory 1)

WE-EF LIGHTING USA, LLC

410-D Keystone Drive, 15086 Warrendale, PA 15086 - Phone: +1 724 742 0030





customersupport.usa@we-ef.com - <https://we-ef.com/us>

Subject to technical changes and errors. - Generated on 11/23/2024

Floodlights

Specifications

Material description

| | |
|----------------------|--|
| Body | Marine-grade, all-aluminium construction |
| Lens | Clear tempered glass lens. |
| Colors |  RAL9004 Black  RAL9007 Grey Metallic  RAL9016 White  RAL8019 Dark Bronze |
| Gasket | Silicone rubber gasket |
| Fasteners | PCS Polymer Coated Stainless Steel hardware |
| Ingress protection | IP55 |
| Impact resistance | IK07 |
| Corrosion resistance | 5CE |

Electrical description

| | |
|------------------|---|
| Power supply | Integral [ECG] electronic 0-10 V dimmable driver in 120-277 universal voltage |
| Driver / Ballast | Integral EC electronic converter in thermally-separated compartment |
| Surge protection | Integral 10kV Surge Protector |

Additional information

| | |
|--------------------------|--|
| Lifetime | Ta=25°/40° L90B10 > 90000h |
| Other Color Temperatures | 2700K, 3500K, 5000K and True Amber available on request. |
| Listings | ETL, UL-1598, CSA-C22.2#250.0. Suitable for Wet Locations. |

WE-EF LIGHTING USA, LLC

410-D Keystone Drive, 15086 Warrendale, PA 15086 - Phone: +1 724 742 0030

customersupport.usa@we-ef.com - <https://we-ef.com/us>

Subject to technical changes and errors. - Generated on 11/23/2024

FLC121 LED - Wall bracket

Floodlights

Options

Light distribution



symmetric, medium beam [M]



symmetric, very narrow beam, 'sharp cut-off' [VNS]



linear spread, very narrow beam, 'sharp cut-off'



symmetric, wide beam [W]



symmetric, very narrow beam [VN]



linear spread, very narrow beam [VN]



wallwash

Color temperature



3000 K



4000 K



2700 K

Nominal Watt

16 W



WE-EF LIGHTING USA, LLC

410-D Keystone Drive, 15086 Warrendale, PA 15086 - Phone: +1 724 742 0030

customersupport.usa@we-ef.com - <https://we-ef.com/us>

Subject to technical changes and errors. - Generated on 11/23/2024

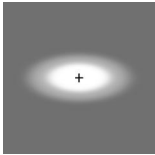
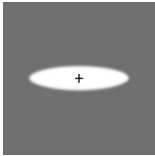
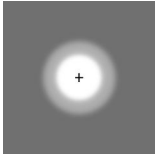
Configurations

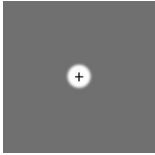
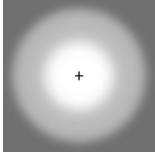
| Light distribution | Part ID | Light source | Rated lumens | Rated input power | CRI | Weight (lb) |
|--|-------------------|-----------------------------|--------------|-------------------|-----|-------------|
| linear spread, very narrow beam [VN]  | 145-0073+145-0050 | LED-6/12W / 700 mA - 3000 K | 1386.3 | 14.5 W | 80 | 6.40 |
| | 145-0074+145-0050 | LED-6/12W / 700 mA - 4000 K | 1481.9 | 14.5 W | 80 | 6.40 |
| | 145-0295+145-0050 | LED-6/12W / 700 mA - 2700 K | 1290.7 | 14.5 W | 80 | 6.40 |
| linear spread, very narrow beam, 'sharp cut-off'  | 145-0040+145-0050 | LED-6/12W / 700 mA - 3000 K | 1526.2 | 14.5 W | 80 | 6.40 |
| | 145-0041+145-0050 | LED-6/12W / 700 mA - 4000 K | 1631.5 | 14.5 W | 80 | 6.40 |
| | 145-0296+145-0050 | LED-6/12W / 700 mA - 2700 K | 1421 | 14.5 W | 80 | 6.40 |
| symmetric, medium beam [M]  | 145-0037 | LED-6/12W / 700 mA - 3000 K | 1511.8 | 14.5 W | 80 | 6.40 |
| | 145-0038 | LED-6/12W / 700 mA - 4000 K | 1616.1 | 14.5 W | 80 | 6.40 |
| | 145-0294 | LED-6/12W / 700 mA - 2700 K | 1407.5 | 14.5 W | 80 | 6.40 |
| symmetric, very narrow beam [VN]  | 145-0073+145-0145 | LED-6/12W / 700 mA - 3000 K | 1496.5 | 14.5 W | 80 | 6.40 |
| | 145-0074 | LED-6/12W / 700 mA - 4000 K | 1599.7 | 14.5 W | 80 | 6.40 |
| | 145-0295 | LED-6/12W / 700 mA - 2700 K | 1393.3 | 14.5 W | 80 | 6.40 |
| symmetric, very narrow beam, 'sharp cut-off' [VNS]  | 145-0040 | LED-6/12W / 700 mA - 3000 K | 1610.7 | 14.5 W | 80 | 6.40 |
| | 145-0041+145-0145 | LED-6/12W / 700 mA - 4000 K | 1721.8 | 14.5 W | 80 | 6.40 |
| | 145-0296 | LED-6/12W / 700 mA - 2700 K | 1499.6 | 14.5 W | 80 | 6.40 |
| symmetric, wide beam [W]  | 145-0070+145-0145 | LED-6/12W / 700 mA - 3000 K | 1347.1 | 14.5 W | 80 | 6.40 |
| | 145-0071 | LED-6/12W / 700 mA - 4000 K | 1440 | 14.5 W | 80 | 6.40 |
| | 145-0293 | LED-6/12W / 700 mA - 2700 K | 1254.2 | 14.5 W | 80 | 6.40 |
| wallwash | 145-0037+145-0145 | LED-6/12W / 700 mA - 3000 K | 1213 | 14.5 W | 80 | 6.40 |
| | 145-0038+145-0145 | LED-6/12W / 700 mA - 4000 K | 1296.6 | 14.5 W | 80 | 6.40 |
| | 145-0294+145-0145 | LED-6/12W / 700 mA - 2700 K | 1129.3 | 14.5 W | 80 | 6.40 |

WE-EF LIGHTING USA, LLC

410-D Keystone Drive, 15086 Warrendale, PA 15086 - Phone: +1 724 742 0030

customersupport.usa@we-ef.com - <https://we-ef.com/us>

Subject to technical changes and errors. - Generated on 11/23/2024

FLC121 LED - Wall bracket



Floodlights

| Light distribution | Part ID | Light source | Rated lumens | Rated input power | CRI | Weight (lb) |
|--|---------|--------------|--------------|-------------------|-----|-------------|
|  | | | | | | |

Optical Accessories

Snoot

| Description | Part ID | A | C1 |
|-------------|----------|-------|-------|
| Snoot ET | 145-0030 | 2.36" | 4.72" |

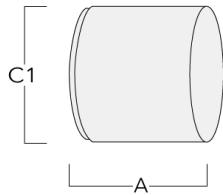

FLC121 LED - Wall bracket

Floodlights

Linear spread lens

| Description | Part ID | C1 |
|-------------------|----------|-------|
| IO-180-FLC121-LED | 145-0050 | 3.19" |

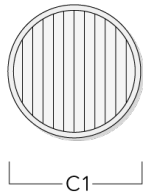

Softening Lens

| Description | Part ID | C1 |
|-------------------|----------|------|
| IO-360-FLC121-LED | 145-0142 | 3.20 |

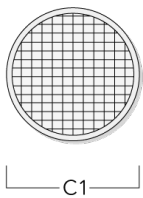

WE-EF LIGHTING USA, LLC

410-D Keystone Drive, 15086 Warrendale, PA 15086 - Phone: +1 724 742 0030
customersupport.usa@we-ef.com - <https://we-ef.com/us>
Subject to technical changes and errors. - Generated on 11/23/2024

FLC121 LED - Wall bracket

Floodlights

Honeycomb louvre

| Description | Part ID | C1 |
|---------------|----------|------|
| IW-FLC121-LED | 145-0143 | 3.20 |

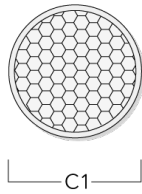

Wallwash lens

| Description | Part ID | C1 |
|---------------------|----------|-------|
| IO-20-WW-FLC121-LED | 145-0145 | 3.19" |

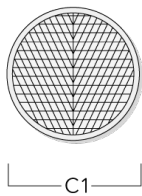

WE-EF LIGHTING USA, LLC

410-D Keystone Drive, 15086 Warrendale, PA 15086 - Phone: +1 724 742 0030
customersupport.usa@we-ef.com - <https://we-ef.com/us>
Subject to technical changes and errors. - Generated on 11/23/2024

Floodlights

Glare shield

| Description | Part ID | A | C1 |
|-----------------|----------|------|------|
| Glare shield ES | 145-9192 | 4.02 | 4.69 |

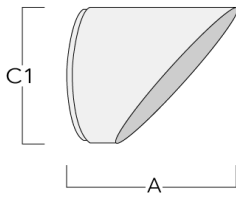

WE-EF LIGHTING USA, LLC

410-D Keystone Drive, 15086 Warrendale, PA 15086 - Phone: +1 724 742 0030
customersupport.usa@we-ef.com - <https://we-ef.com/us>

Subject to technical changes and errors. - Generated on 11/23/2024