

Description



IP66, Class I. IK07. Marine-grade, die-cast aluminium alloy. 5CE superior corrosion protection + primer including PCS hardware. Safety glass lens. Silicone CCG® Controlled Compression Gasket. Luminaire is factory-sealed and does not need to be opened during installation.

Integral EC electronic converter in thermally-separated compartment. Advanced thermal management protects LEDs while optimising lumens output. CAD-optimised optics for superior illumination and glare control. OLC® One LED Concept.

Including 0.4 m of flexible cable enclosed in a stainless conduit, in-line connector and mounting clamp for installation to RAIL66 mounting system.

If ordering a fitting to be installed on an existing rail, please confirm the rail version with your local distributor or our customer excellence team as connectors vary.

Specifications**Material description**

| | |
|----------------------|---|
| Body | Marine-grade die-cast aluminium alloy |
| Lens | Safety glass lens |
| Colours |  RAL9004 Signal black  RAL9006 White aluminium  RAL9007 Grey aluminium |
| Gasket | Silicone CCG® Controlled Compression Gasket |
| Fasteners | PCS Polymer Coated Stainless Steel Hardware (unpainted) |
| Ingress protection | IP66 |
| Impact resistance | IK07 |
| Corrosion resistance | 5CE+Primer |

Electrical description

| | |
|------------------|---|
| Power supply | 230V / 50 Hz |
| Driver / Ballast | Integral EC electronic converter in thermally-separated compartment |

Additional information

| | |
|----------|--|
| Lifetime | Ta=40° L90B10 > 90000h |
| Warranty | The product is supplied with 10-year warranty. Please refer to the LED Warranty Statement located on www.we-ef.com for further details. |

Options

Light distribution



symmetric, medium beam [M]



symmetric, very narrow beam, sharp cut-off [EES]



symmetric, wide beam [B]



symmetric, very narrow beam [EE]



linear spread, very narrow beam [EE]



linear spread, very narrow beam, sharp cut-off [EES]



wallwash [A20]

Colour temperature



3000 K



4000 K

RGBW







2700 K

Nominal Watt

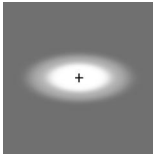
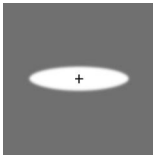
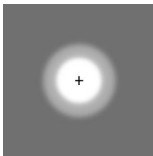
56 W

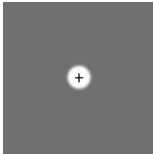
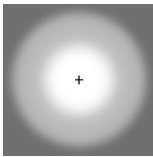
Configurations

| Light distribution | Part ID | Light source | Rated lumens | Rated input power | CRI | Weight (kg) |
|--|-------------------|------------------------------|--------------|-------------------|-------|-------------|
| linear spread, very narrow beam [EE]  | 146-0986+146-0439 | LED-24/48W / 700 mA - 2700 K | 5162.8 | 54 W | 80 | 4.70 |
| | 146-7072+146-0439 | LED-24/48W / 700 mA - 3000 K | 5545.2 | 54 W | 80 | 4.80 |
| | 146-7073+146-0439 | LED-24/48W / 700 mA - 4000 K | 5927.6 | 54 W | 80 | 4.80 |
| linear spread, very narrow beam, sharp cut-off [EES]  | 146-0987+146-0439 | LED-24/48W / 700 mA - 2700 K | 5683.9 | 54 W | 80 | 4.70 |
| | 146-7060+146-0439 | LED-24/48W / 700 mA - 3000 K | 6104.9 | 54 W | 80 | 4.80 |
| | 146-7061+146-0439 | LED-24/48W / 700 mA - 4000 K | 6526 | 54 W | 80 | 4.80 |
| symmetric, medium beam [M]  | 146-0985 | LED-24/48W / 700 mA - 2700 K | 5630.1 | 54 W | 80 | 4.70 |
| | 146-7058 | LED-24/48W / 700 mA - 3000 K | 6047.2 | 54 W | 80 | 4.70 |
| | 146-7059 | LED-24/48W / 700 mA - 4000 K | 6464.2 | 54 W | 80 | 4.70 |
| | 146-8298 | LED-24/48W - RGBW | 2963.9 | 54 W | 20/80 | 0.00 |
| symmetric, very narrow beam [EE]  | 146-0986 | LED-24/48W / 700 mA - 2700 K | 5573.3 | 54 W | 80 | 4.70 |
| | 146-7072 | LED-24/48W / 700 mA - 3000 K | 5986.1 | 54 W | 80 | 4.70 |
| | 146-7073 | LED-24/48W / 700 mA - 4000 K | 6398.9 | 54 W | 80 | 4.70 |
| | 146-8296 | LED-24/48W - RGBW | 2921.6 | 54 W | 20/80 | 0.00 |
| symmetric, very narrow beam, sharp cut-off [EES]  | 146-0987 | LED-24/48W / 700 mA - 2700 K | 5998.4 | 54 W | 80 | 4.70 |
| | 146-7060 | LED-24/48W / 700 mA - 3000 K | 6442.7 | 54 W | 80 | 4.70 |
| | 146-7061 | LED-24/48W / 700 mA - 4000 K | 6887 | 54 W | 80 | 4.70 |
| symmetric, wide beam [B]  | 146-0984 | LED-24/48W / 700 mA - 2700 K | 5016.9 | 54 W | 80 | 4.70 |
| | 146-7070 | LED-24/48W / 700 mA - 3000 K | 5388.5 | 54 W | 80 | 4.70 |
| | 146-7071 | LED-24/48W / 700 mA - 4000 K | 5760.1 | 54 W | 80 | 4.70 |
| | 146-8299 | LED-24/48W - RGBW | 2666.8 | 54 W | 20/80 | 0.00 |
| wallwash [A20]  | 146-0985+146-0646 | LED-24/48W / 700 mA - 2700 K | 4517.3 | 54 W | 80 | 4.70 |
| | 146-7058+146-0646 | LED-24/48W / 700 mA - 3000 K | 4851.9 | 54 W | 80 | 4.80 |
| | 146-7059+146-0646 | LED-24/48W / 700 mA - 4000 K | 5186.6 | 54 W | 80 | 4.80 |

Optical Accessories

Glare shield

| Description | Part ID | A | C1 |
|-----------------|----------|-----|-----|
| Glare shield ES | 146-0229 | 120 | 145 |

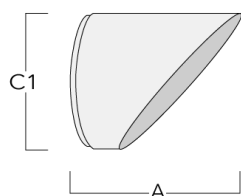

Snoot

| Description | Part ID | A | C1 |
|-------------|----------|-----|-----|
| Snoot ET | 146-0398 | 120 | 145 |

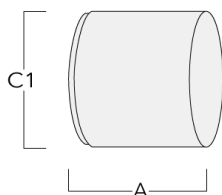

RAIL66**Linear louver**

| Description | Part ID | C1 |
|---------------------------------|----------|-----|
| Linear louver IL for FLC141 LED | 146-9056 | 145 |

**Honeycomb louver**

| Description | Part ID | C1 |
|---------------|----------|-----|
| IW-FLC141-LED | 146-0626 | 145 |

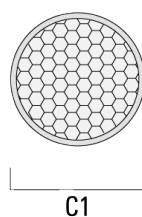

Mounting Accessories

Universal

| Description | Part ID | C1 | C2 | H1 | M1 | Weight (kg) | L1 | L2 |
|--------------------------|----------|----|----|-----|----|-------------|------|------|
| 2 Mains outlets (L=1150) | 310-9200 | 75 | 30 | 200 | 12 | 5.90 | 1150 | 1045 |

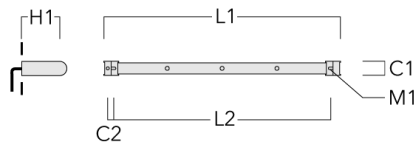

| | | | | | | | | |
|--------------------------|----------|----|----|-----|----|------|------|------|
| 3 Mains outlets (L=1150) | 310-9202 | 75 | 30 | 200 | 12 | 5.90 | 1150 | 1045 |
|--------------------------|----------|----|----|-----|----|------|------|------|

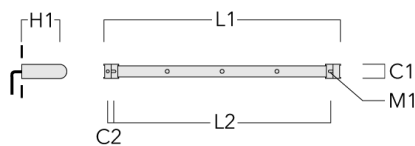

FLC141 LED RAIL66

RAIL66

| Description | Part ID | C1 | C2 | H1 | M1 | Weight (kg) | L1 | L2 |
|--------------------------|----------|----|----|-----|----|-------------|------|------|
| 3 Mains outlets (L=1650) | 310-9210 | 75 | 30 | 200 | 12 | 7.20 | 1650 | 1545 |

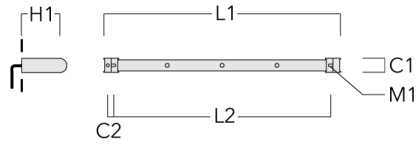

| | | | | | | | | |
|--------------------------|----------|----|----|-----|----|------|------|------|
| 4 Mains outlets (L=1650) | 310-9212 | 75 | 30 | 200 | 12 | 7.20 | 1650 | 1545 |
|--------------------------|----------|----|----|-----|----|------|------|------|

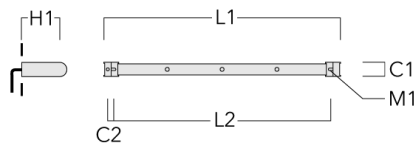

RAIL66

| Description | Part ID | C1 | C2 | H1 | M1 | Weight (kg) | L1 | L2 |
|--------------------------|----------|----|----|-----|----|-------------|------|------|
| 4 Mains outlets (L=2150) | 310-9220 | 75 | 30 | 200 | 12 | 8.50 | 2150 | 2045 |

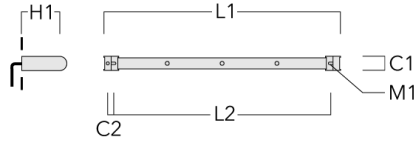

| | | | | | | | | |
|--------------------------|----------|----|----|-----|----|------|------|------|
| 6 Mains outlets (L=2150) | 310-9222 | 75 | 30 | 200 | 12 | 8.50 | 2150 | 2045 |
|--------------------------|----------|----|----|-----|----|------|------|------|

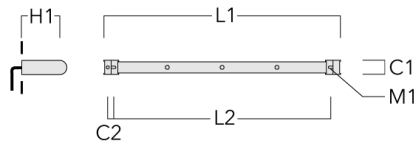

RAIL66

Flat Surface Fitters

| Description | Part ID | C1 | C2 | D1 | D2 | L | M1 | Weight (kg) |
|------------------------|----------|----|----|-----|-----|------|----|-------------|
| Surface fitters (pair) | 310-9290 | 20 | 30 | 180 | 140 | 1070 | 9 | 1.70 |

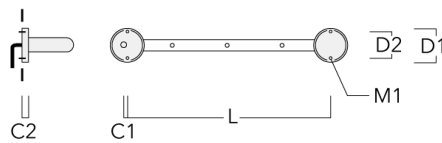

Cantilever

| Description | Part ID | C1 | C2 | C3 | H1 | M1 | Weight (kg) | L1 | L2 |
|--------------------------|----------|-----|-----|----|-----|----|-------------|------|------|
| 2 Mains outlets (L=1150) | 310-9230 | 220 | 120 | 60 | 600 | 13 | 12 | 1150 | 1070 |

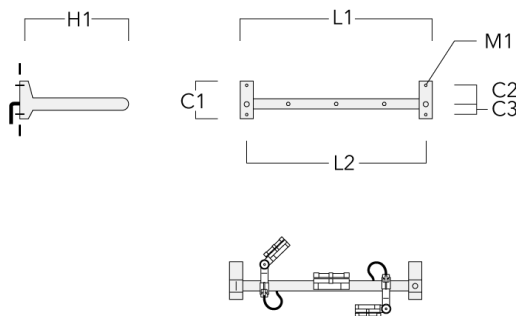

RAIL66

| Description | Part ID | C1 | C2 | C3 | H1 | M1 | Weight (kg) | L1 | L2 |
|--------------------------|----------|-----|-----|----|-----|----|-------------|------|------|
| 3 Mains outlets (L=1150) | 310-9232 | 220 | 120 | 60 | 600 | 13 | 12 | 1150 | 1070 |

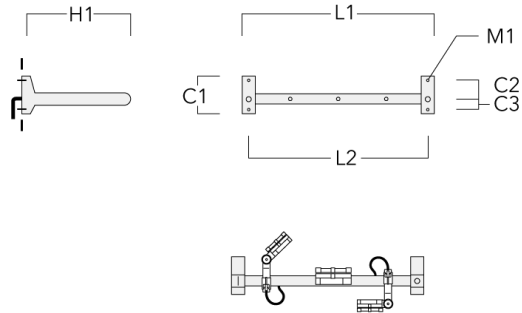

| | | | | | | | | | |
|--------------------------|----------|-----|-----|----|-----|----|-------|------|------|
| 3 Mains outlets (L=1650) | 310-9240 | 220 | 120 | 60 | 600 | 13 | 13.30 | 1650 | 1570 |
|--------------------------|----------|-----|-----|----|-----|----|-------|------|------|

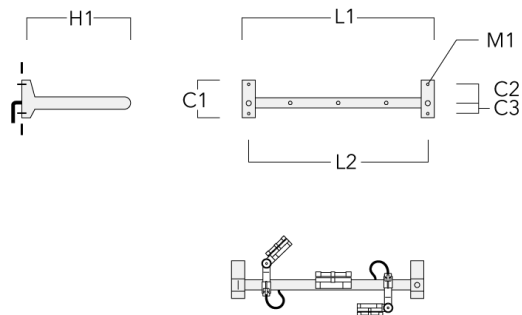

RAIL66

| Description | Part ID | C1 | C2 | C3 | H1 | M1 | Weight (kg) | L1 | L2 |
|--------------------------|----------|-----|-----|----|-----|----|-------------|------|------|
| 4 Mains outlets (L=1650) | 310-9242 | 220 | 120 | 60 | 600 | 13 | 13.30 | 1650 | 1570 |

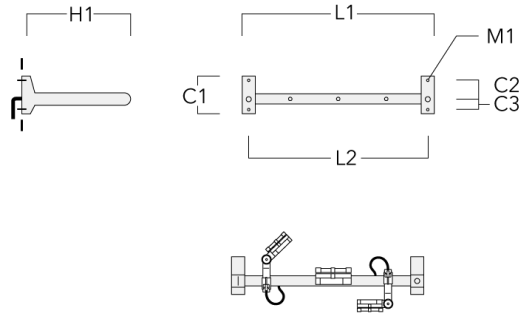

| | | | | | | | | | |
|--------------------------|----------|-----|-----|----|-----|----|-------|------|------|
| 4 Mains outlets (L=2150) | 310-9250 | 220 | 120 | 60 | 600 | 13 | 14.60 | 2150 | 2070 |
|--------------------------|----------|-----|-----|----|-----|----|-------|------|------|

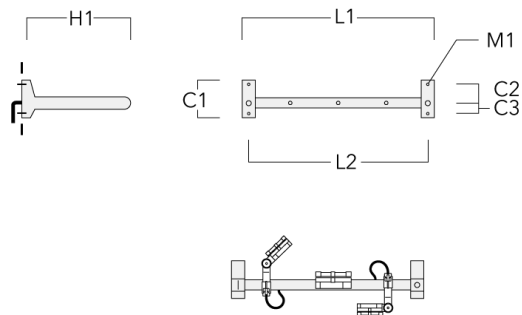

RAIL66

| Description | Part ID | C1 | C2 | C3 | H1 | M1 | Weight (kg) | L1 | L2 |
|--------------------------|----------|-----|-----|----|-----|----|-------------|------|------|
| 6 Mains outlets (L=2150) | 310-9252 | 220 | 120 | 60 | 600 | 13 | 14.60 | 2150 | 2070 |

