

VFL530 LED

Pole mounted

we-ef

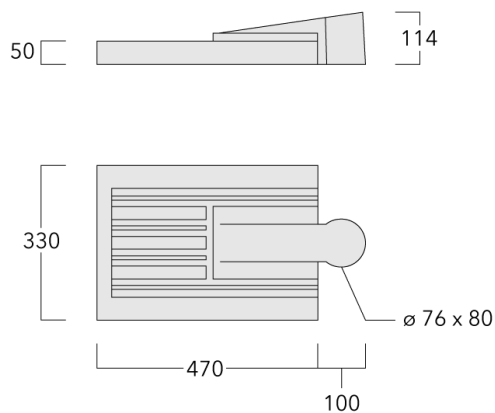

Description

IP66, Class I or Class II. IK08. Marine-grade, die-cast aluminium alloy. 5CE superior corrosion protection including PCS hardware. Silicone CCG® Controlled Compression Gasket. RFC® Reflection Free Contour main lens. Integral EC electronic converter in thermally separated compartment. DALI. CAD-optimised optics for superior illumination and glare control. OLC® One LED Concept. Factory installed LED circuit board. The luminaire is factory-sealed and does not need to be opened during installation.

Optional 2200 K version available. To be specified at time of ordering.

Eco Step Dim® on request.

Spigot Ø 60 x 80 mm optional available. Must be indicated during order placement.





Fagerhult Lighting Ltd

33-34 Dolben Street, SE1 0UQ London, United Kingdom

<https://we-ef.com/uk>

Subject to technical changes and errors. - Generated on 24/11/2024

Specifications**Material description**

Body	Marine-grade, die-cast aluminium alloy
Lens	RFC® Reflection Free Contour technology
Colours	 RAL9004 Signal black  RAL9006 White aluminium  RAL9007 Grey aluminium  RAL7016 Anthracite grey  RAL9016 Traffic white
Gasket	Silicone CCG® Controlled Compression Gasket
Fasteners	PCS Polymer Coated Stainless Steel Hardware
Ingress protection	IP66
Impact resistance	IK08
Corrosion resistance	5CE
Windage	0.163 m ²

Electrical description

Power supply	220-240V / 50-60 Hz
Driver / Ballast	Integral EC electronic converter. DALI
Power factor	> 0.9
Surge protection	6/6 kV

Additional information

Lifetime	Ta=25° L90B10 > 90000h
Energy efficiency class	C-D (Light source)

VFL530 LED

Pole mounted

we-ef

Options

Light distribution

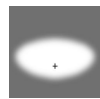

asymmetric, side throw beam [S60]

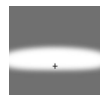

asymmetric, side throw [S70]



asymmetric, forward throw [A60]



asymmetric, side throw beam [S65]



rectangular, side throw [R65]

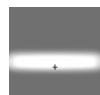

pedestrian/bicycle lane [P65]



pedestrian crossing, left-hand traffic [P45L]

Colour temperature



3000 K



4000 K



2700 K

Nominal Watt

15 W

29 W

58 W

Configurations

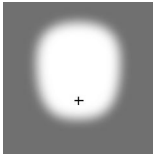
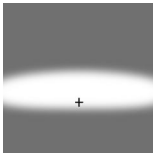
Light distribution	Part ID	Light source	Rated lumens	Rated input power	CRI	Weight (kg)
asymmetric, forward throw [A60] 	108-1129	LED-12/12W / 350 mA - 3000 K	1626.1	13.9 W	80	6.40
	108-1129-70	LED-12/12W / 350 mA - 3000 K	1888.4	13.9 W	70	6.40
	108-1130	LED-12/12W / 350 mA - 4000 K	1783.5	13.9 W	80	6.40
	108-1130-70	LED-12/12W / 350 mA - 4000 K	1993.3	13.9 W	70	6.40
	108-1144	LED-12/24W / 700 mA - 3000 K	2887.4	27 W	80	6.40
	108-1144-70	LED-12/24W / 700 mA - 3000 K	3285.6	27 W	70	6.40
	108-1145	LED-12/24W / 700 mA - 4000 K	3086.5	27 W	80	6.40
	108-1145-70	LED-12/24W / 700 mA - 4000 K	3484.8	27 W	70	6.40
	108-1159	LED-24/24W / 350 mA - 3000 K	3252.2	26.5 W	80	6.60
	108-1159-70	LED-24/24W / 350 mA - 3000 K	3776.8	26.5 W	70	6.60
	108-1160	LED-24/24W / 350 mA - 4000 K	3566.9	26.5 W	80	6.60
	108-1160-70	LED-24/24W / 350 mA - 4000 K	3986.6	26.5 W	70	6.60
	108-1174	LED-24/48W / 700 mA - 3000 K	5774.8	54 W	80	6.60
	108-1174-70	LED-24/48W / 700 mA - 3000 K	6571.3	54 W	70	6.60
	108-1175	LED-24/48W / 700 mA - 4000 K	6173	54 W	80	6.60
	108-1175-70	LED-24/48W / 700 mA - 4000 K	6969.6	54 W	70	6.60
	108-2040	LED-24/72W / 1050 mA - 3000 K	8506.1	81 W	80	6.60
	108-2040-70	LED-24/72W / 1050 mA - 3000 K	9693	81 W	70	6.60
	108-2041	LED-24/72W / 1050 mA - 4000 K	8901.8	81 W	80	6.40
	108-2041-70	LED-24/72W / 1050 mA - 4000 K	10088.7	81 W	70	6.40
	108-2331	LED-12/12W / 350 mA - 2700 K	1521.2	13.9 W	80	6.40
	108-2331-70	LED-12/12W / 350 mA - 2700 K	1626.1	13.9 W	70	6.40
	108-2332	LED-12/24W / 700 mA - 2700 K	2688.3	27 W	80	6.40
	108-2332-70	LED-12/24W / 700 mA - 2700 K	2887.4	27 W	70	6.40
	108-2333	LED-24/24W / 350 mA - 2700 K	3042.4	26.5 W	80	6.60
	108-2333-70	LED-24/24W / 350 mA - 2700 K	3252.2	26.5 W	70	6.60
108-2334	LED-24/48W / 700 mA - 2700 K	5376.5	54 W	80	6.60	
108-2334-70	LED-24/48W / 700 mA - 2700 K	5774.8	54 W	70	6.60	
108-2348	LED-24/72W / 1050 mA - 2700 K	8110.5	81 W	80	6.60	
108-2348-70	LED-24/72W / 1050 mA - 2700 K	9297.4	81 W	70	6.60	
asymmetric, side throw [S70] 	108-1126	LED-12/12W / 350 mA - 3000 K	1720.2	13.9 W	80	6.40
	108-1126-70	LED-12/12W / 350 mA - 3000 K	1997.6	13.9 W	70	6.40
	108-1127	LED-12/12W / 350 mA - 4000 K	1886.7	13.9 W	80	6.40
	108-1127-70	LED-12/12W / 350 mA - 4000 K	2108.6	13.9 W	70	6.40
	108-1141	LED-12/24W / 700 mA - 3000 K	3090.4	27 W	80	6.40

Light distribution	Part ID	Light source	Rated lumens	Rated input power	CRI	Weight (kg)
	108-1141-70	LED-12/24W / 700 mA - 3000 K	3516.7	27 W	70	6.40
	108-1142	LED-12/24W / 700 mA - 4000 K	3303.5	27 W	80	6.40
	108-1142-70	LED-12/24W / 700 mA - 4000 K	3729.8	27 W	70	6.40
	108-1156	LED-24/24W / 350 mA - 3000 K	3440.4	26.5 W	80	6.60
	108-1156-70	LED-24/24W / 350 mA - 3000 K	3995.3	26.5 W	70	6.60
	108-1157	LED-24/24W / 350 mA - 4000 K	3773.3	26.5 W	80	6.60
	108-1157-70	LED-24/24W / 350 mA - 4000 K	4217.2	26.5 W	70	6.60
	108-1171	LED-24/48W / 700 mA - 3000 K	6180.8	54 W	80	6.60
	108-1171-70	LED-24/48W / 700 mA - 3000 K	7033.3	54 W	70	6.60
	108-1172	LED-24/48W / 700 mA - 4000 K	6607.1	54 W	80	6.60
	108-1172-70	LED-24/48W / 700 mA - 4000 K	7459.6	54 W	70	6.60
	108-1872-70	LED-24/48W / 700 mA - 2700 K	6180.8	54 W	70	6.60
	108-2050	LED-24/72W / 1050 mA - 3000 K	9056.9	81 W	80	6.60
	108-2050-70	LED-24/72W / 1050 mA - 3000 K	10320.7	81 W	70	6.60
	108-2051	LED-24/72W / 1050 mA - 4000 K	9478.2	81 W	80	6.60
	108-2051-70	LED-24/72W / 1050 mA - 4000 K	10741.9	81 W	70	6.60
	108-2325	LED-12/12W / 350 mA - 2700 K	1609.2	13.9 W	80	6.40
	108-2325-70	LED-12/12W / 350 mA - 2700 K	1720.2	13.9 W	70	6.40
	108-2326	LED-12/24W / 700 mA - 2700 K	2877.3	27 W	80	6.40
	108-2326-70	LED-12/24W / 700 mA - 2700 K	3440.4	26.5 W	70	6.40
	108-2327	LED-24/24W / 350 mA - 2700 K	3218.4	26.5 W	80	6.60
	108-2327-70	LED-24/24W / 350 mA - 2700 K	3440.4	26.5 W	70	6.60
	108-2346	LED-24/72W / 1050 mA - 2700 K	8635.7	81 W	80	6.60
	108-2346-70	LED-24/72W / 1050 mA - 2700 K	9899.4	81 W	70	6.60
asymmetric, side throw beam [S60]	108-1123	LED-12/12W / 350 mA - 3000 K	1725.2	13.9 W	80	6.40
	108-1123-70	LED-12/12W / 350 mA - 3000 K	2003.4	13.9 W	70	6.40
	108-1124	LED-12/12W / 350 mA - 4000 K	1892.1	13.9 W	80	6.40
	108-1124-70	LED-12/12W / 350 mA - 4000 K	2114.7	13.9 W	70	6.40
	108-1138	LED-12/24W / 700 mA - 3000 K	3120.9	27 W	80	6.40
	108-1138-70	LED-12/24W / 700 mA - 3000 K	3551.3	27 W	70	6.40
	108-1139	LED-12/24W / 700 mA - 4000 K	3336.1	27 W	80	6.40
	108-1139-70	LED-12/24W / 700 mA - 4000 K	3766.6	27 W	70	6.40
	108-1153	LED-24/24W / 350 mA - 3000 K	3450.3	26.5 W	80	6.60
	108-1153-70	LED-24/24W / 350 mA - 3000 K	4006.8	26.5 W	70	6.60
	108-1154	LED-24/24W / 350 mA - 4000 K	3784.2	26.5 W	80	6.60
	108-1154-70	LED-24/24W / 350 mA - 4000 K	4229.4	26.5 W	70	6.60

asymmetric, side throw beam [S60]

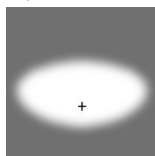

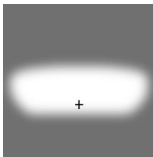
Light distribution	Part ID	Light source	Rated lumens	Rated input power	CRI	Weight (kg)
	108-1168	LED-24/48W / 700 mA - 3000 K	6241.8	54 W	80	6.60
	108-1168-70	LED-24/48W / 700 mA - 3000 K	7102.7	54 W	70	6.60
	108-1169	LED-24/48W / 700 mA - 4000 K	6672.2	54 W	80	6.60
	108-1169-70	LED-24/48W / 700 mA - 4000 K	7533.2	54 W	70	6.60
	108-2046	LED-24/72W / 1050 mA - 3000 K	9200.3	81 W	80	6.60
	108-2046-70	LED-24/72W / 1050 mA - 3000 K	10484	81 W	70	6.60
	108-2047	LED-24/72W / 1050 mA - 4000 K	9628.2	81 W	80	6.60
	108-2047-70	LED-24/72W / 1050 mA - 4000 K	10911.9	81 W	70	6.60
	108-2317	LED-12/12W / 350 mA - 2700 K	1613.9	13.9 W	80	6.40
	108-2317-70	LED-12/12W / 350 mA - 2700 K	1725.2	13.9 W	70	6.40
	108-2318	LED-12/24W / 700 mA - 2700 K	3005.1	27 W	80	6.40
	108-2318-70	LED-12/24W / 700 mA - 2700 K	3227.7	27 W	70	6.40
	108-2319	LED-24/24W / 350 mA - 2700 K	3227.7	26.5 W	80	6.60
	108-2319-70	LED-24/24W / 350 mA - 2700 K	3450.3	26.5 W	70	6.60
	108-2320	LED-24/48W / 700 mA - 2700 K	5811.3	54 W	80	6.60
	108-2320-70	LED-24/48W / 700 mA - 2700 K	6241.8	54 W	70	6.60
	108-2344	LED-24/72W / 1050 mA - 2700 K	8772.3	81 W	80	6.60
	108-2344-70	LED-24/72W / 1050 mA - 2700 K	10056.1	81 W	70	6.60
asymmetric, side throw beam [S65]	108-1132	LED-12/12W / 350 mA - 3000 K	1749.4	13.9 W	80	6.40
	108-1132-70	LED-12/12W / 350 mA - 3000 K	2031.6	13.9 W	70	6.40
	108-1133	LED-12/12W / 350 mA - 4000 K	1918.7	13.9 W	80	6.40
	108-1133-70	LED-12/12W / 350 mA - 4000 K	2144.4	13.9 W	70	6.40
	108-1147	LED-12/24W / 700 mA - 3000 K	3156	27 W	80	6.40
	108-1147-70	LED-12/24W / 700 mA - 3000 K	3591.3	27 W	70	6.40
	108-1148	LED-12/24W / 700 mA - 4000 K	3373.6	27 W	80	6.40
	108-1148-70	LED-12/24W / 700 mA - 4000 K	3809	27 W	70	6.40
	108-1162	LED-24/24W / 350 mA - 3000 K	3498.8	26.5 W	80	6.60
	108-1162-70	LED-24/24W / 350 mA - 3000 K	4063.1	26.5 W	70	6.60
	108-1163	LED-24/24W / 350 mA - 4000 K	3837.4	26.5 W	80	6.60
	108-1163-70	LED-24/24W / 350 mA - 4000 K	4288.9	26.5 W	70	6.60
	108-1177	LED-24/48W / 700 mA - 3000 K	6312	54 W	80	6.60
	108-1177-70	LED-24/48W / 700 mA - 3000 K	7182.6	54 W	70	6.60
	108-1178	LED-24/48W / 700 mA - 4000 K	6747.3	54 W	80	6.60
	108-1178-70	LED-24/48W / 700 mA - 4000 K	7617.9	54 W	70	6.60
	108-2048	LED-24/72W / 1050 mA - 3000 K	9380.3	81 W	80	6.60
	108-2048-70	LED-24/72W / 1050 mA - 3000 K	10689.2	81 W	70	6.60

Light distribution	Part ID	Light source	Rated lumens	Rated input power	CRI	Weight (kg)	
	108-2049	LED-24/72W / 1050 mA - 4000 K	9816.6	81 W	80	6.60	
	108-2049-70	LED-24/72W / 1050 mA - 4000 K	11125.5	81 W	70	6.60	
	108-2321	LED-12/12W / 350 mA - 2700 K	1636.5	13.9 W	80	6.40	
	108-2321-70	LED-12/12W / 350 mA - 2700 K	1749.4	13.9 W	70	6.40	
	108-2322	LED-12/24W / 700 mA - 2700 K	3047.3	27 W	80	6.40	
	108-2322-70	LED-12/24W / 700 mA - 2700 K	3273.1	27 W	70	6.40	
	108-2323	LED-24/24W / 350 mA - 2700 K	3273.1	26.5 W	80	6.60	
	108-2323-70	LED-24/24W / 350 mA - 2700 K	3498.8	26.5 W	70	6.60	
	108-2324	LED-24/48W / 700 mA - 2700 K	5876.7	54 W	80	6.60	
	108-2324-70	LED-24/48W / 700 mA - 2700 K	6312	54 W	70	6.60	
	108-2345	LED-24/72W / 1050 mA - 2700 K	8944.1	81 W	80	6.60	
	108-2345-70	LED-24/72W / 1050 mA - 2700 K	10252.9	81 W	70	6.60	
	pedestrian crossing, left-hand traffic [P45L]	108-2807	LED-24/72W / 1050 mA - 2700 K	8603.3	81 W	80	6.60
		108-2808	LED-24/72W / 1050 mA - 3000 K	9023	81 W	80	6.60
108-2809		LED-24/72W / 1050 mA - 4000 K	9442.7	81 W	80	6.60	
pedestrian/bicycle lane [P65]	108-1552	LED-12/12W / 350 mA - 3000 K	1708.3	13.9 W	80	6.40	
	108-1552-70	LED-12/12W / 350 mA - 3000 K	1983.8	13.9 W	70	6.40	
	108-1553	LED-12/12W / 350 mA - 4000 K	1873.6	13.9 W	80	6.40	
	108-1553-70	LED-12/12W / 350 mA - 4000 K	2094.1	13.9 W	70	6.40	
	108-1554	LED-12/24W / 700 mA - 3000 K	3122.4	27 W	80	6.40	
	108-1554-70	LED-12/24W / 700 mA - 3000 K	3553.1	27 W	70	6.40	
	108-1555	LED-12/24W / 700 mA - 4000 K	3337.7	27 W	80	6.40	
	108-1555-70	LED-12/24W / 700 mA - 4000 K	3768.4	27 W	70	6.40	
	108-1556	LED-24/24W / 350 mA - 3000 K	3416.6	26.5 W	80	6.60	
	108-1556-70	LED-24/24W / 350 mA - 3000 K	3967.7	26.5 W	70	6.60	
	108-1557	LED-24/24W / 350 mA - 4000 K	3747.2	26.5 W	80	6.60	
	108-1557-70	LED-24/24W / 350 mA - 4000 K	4188.1	26.5 W	70	6.60	
	108-1558	LED-24/48W / 700 mA - 3000 K	6244.8	54 W	80	6.60	
	108-1558-70	LED-24/48W / 700 mA - 3000 K	7106.1	54 W	70	6.60	
	108-1559	LED-24/48W / 700 mA - 4000 K	6675.5	54 W	80	6.60	
	108-1559-70	LED-24/48W / 700 mA - 4000 K	7536.8	54 W	70	6.60	
	108-2042	LED-24/72W / 1050 mA - 3000 K	9379	81 W	80	6.60	
	108-2042-70	LED-24/72W / 1050 mA - 3000 K	10687.7	81 W	70	6.60	
	108-2043	LED-24/72W / 1050 mA - 4000 K	9815.2	81 W	80	6.60	

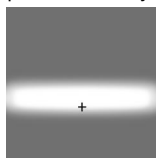
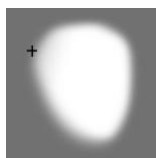

VFL530 LED

Pole mounted

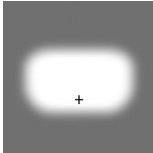
Light distribution	Part ID	Light source	Rated lumens	Rated input power	CRI	Weight (kg)
	108-2043-70	LED-24/72W / 1050 mA - 4000 K	11123.9	81 W	70	6.60
	108-2241	LED-12/24W / 700 mA - 2700 K	2907.1	27 W	80	6.40
	108-2241-70	LED-12/24W / 700 mA - 2700 K	3122.4	27 W	70	6.40
	108-2335	LED-12/12W / 350 mA - 2700 K	1598.1	13.9 W	80	6.40
	108-2335-70	LED-12/12W / 350 mA - 2700 K	1708.3	13.9 W	70	6.40
	108-2336	LED-24/24W / 350 mA - 2700 K	3196.2	26.5 W	80	6.60
	108-2336-70	LED-24/24W / 350 mA - 2700 K	3416.6	26.5 W	70	6.60
	108-2337	LED-24/48W / 700 mA - 2700 K	5814.1	54 W	80	6.60
	108-2337-70	LED-24/48W / 700 mA - 2700 K	6244.8	54 W	70	6.60
	108-2349	LED-24/72W / 1050 mA - 2700 K	8942.8	81 W	80	6.60
	108-2349-70	LED-24/72W / 1050 mA - 2700 K	10251.5	81 W	70	6.60
rectangular, side throw [R65]	108-1135	LED-12/12W / 350 mA - 3000 K	1671.9	13.9 W	80	6.40
	108-1135-70	LED-12/12W / 350 mA - 3000 K	1941.6	13.9 W	70	6.40
	108-1136	LED-12/12W / 350 mA - 4000 K	1833.7	13.9 W	80	6.40
	108-1136-70	LED-12/12W / 350 mA - 4000 K	2049.4	13.9 W	70	6.40
	108-1150	LED-12/24W / 700 mA - 3000 K	2927.2	27 W	80	6.40
	108-1150-70	LED-12/24W / 700 mA - 3000 K	3331	27 W	70	6.40
	108-1151	LED-12/24W / 700 mA - 4000 K	3129.1	27 W	80	6.40
	108-1151-70	LED-12/24W / 700 mA - 4000 K	3532.9	27 W	70	6.40
	108-1165	LED-24/24W / 350 mA - 3000 K	3343.8	26.5 W	80	6.60
	108-1165-70	LED-24/24W / 350 mA - 3000 K	3883.2	26.5 W	70	6.60
	108-1166	LED-24/24W / 350 mA - 4000 K	3667.4	26.5 W	80	6.60
	108-1166-70	LED-24/24W / 350 mA - 4000 K	4098.9	26.5 W	70	6.60
	108-1180	LED-24/48W / 700 mA - 3000 K	5854.5	54 W	80	6.60
	108-1180-70	LED-24/48W / 700 mA - 3000 K	6662	54 W	70	6.60
	108-1181	LED-24/48W / 700 mA - 4000 K	6258.2	54 W	80	6.60
	108-1181-70	LED-24/48W / 700 mA - 4000 K	7065.7	54 W	70	6.60
	108-2044	LED-24/72W / 1050 mA - 3000 K	8699.8	81 W	80	6.60
	108-2044-70	LED-24/72W / 1050 mA - 3000 K	9913.8	81 W	70	6.60
	108-2045	LED-24/72W / 1050 mA - 4000 K	9104.5	81 W	80	6.40
	108-2045-70	LED-24/72W / 1050 mA - 4000 K	10318.4	81 W	70	6.40
	108-2240	LED-12/24W / 700 mA - 2700 K	2725.4	27 W	80	6.40
	108-2240-70	LED-12/24W / 700 mA - 2700 K	2927.2	27 W	70	6.40
	108-2328	LED-12/12W / 350 mA - 2700 K	1564.1	13.9 W	80	6.40
	108-2328-70	LED-12/12W / 350 mA - 2700 K	1671.9	13.9 W	70	6.40
	108-2329	LED-24/24W / 350 mA - 2700 K	3128.1	26.5 W	80	6.60

VFL530 LED

Pole mounted

Light distribution	Part ID	Light source	Rated lumens	Rated input power	CRI	Weight (kg)
	108-2329-70	LED-24/24W / 350 mA - 2700 K	3343.8	26.5 W	70	6.60
	108-2330	LED-24/48W / 700 mA - 2700 K	5450.7	54 W	80	6.60
	108-2330-70	LED-24/48W / 700 mA - 2700 K	5854.5	54 W	70	6.60
	108-2347	LED-24/72W / 1050 mA - 2700 K	8295.2	81 W	80	6.60
	108-2347-70	LED-24/72W / 1050 mA - 2700 K	9509.1	81 W	70	6.60

VFL530 LED

Pole mounted

we-ef

Control

Eco Step Dim® Basic

Description	Part ID
Eco Step Dim® Basic LED	430-0001

Eco Step Dim® Advanced

Description	Part ID
Eco Step Dim® Advanced LED	430-0002

Eco Step Dim® Motion

Description	Part ID
Eco Step Dim® Motion - Linked	430-0021

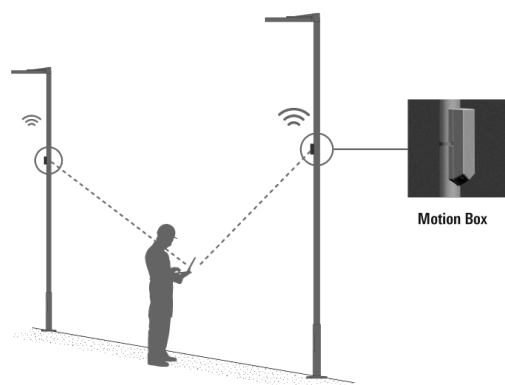

VFL530 LED

Pole mounted

Description	Part ID
Eco Step Dim® Motion - Connected	430-0022

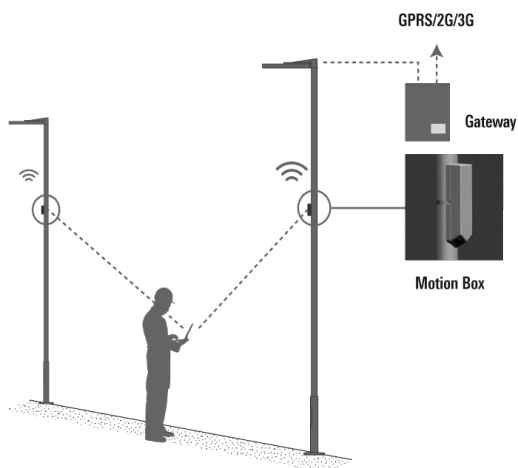

R2C Ready to Connect

Description	Part ID
R2C Ready to Connect (top)	430-0019
R2C Ready to Connect (below)	430-0027
R2C Ready to Connect (top and below)	430-0032

Fagerhult Lighting Ltd

33-34 Dolben Street, SE1 0UQ London, United Kingdom

<https://we-ef.com/uk>

Subject to technical changes and errors. - Generated on 24/11/2024

Citygrid Motion On Pole

Description	Part ID	Additional information
Citygrid Motion - Smart-City-Package	420-0013	<p>Citygrid Motion On Pole Controller</p> <p>The Citygrid Motion On Pole Controller is the all-in-one device that can convert existing luminaires into an intelligent lighting system.</p> <p>The Smart-City package:</p> <p>Internet gateway (via mobile phone) and dashboard included; operators can configure, change and service themselves (remotely). Networked Smart-City functions (data collection, remote maintenance, etc.).</p> <p>Applications: larger communal projects or field trials in the context of Smart City; operator has qualified personnel (municipal utilities).</p>



Mounting Accessories

Wall and pole brackets RV

Description	Part ID	Additional information	C1	C2	C3	D1	D × L1	H1	H2	M1	M2	Weight (kg)	C	D	H
RV0 Wall bracket	108-0979	RV0 Wall bracket	108	100	60			200	160	38	12	2.00	108		

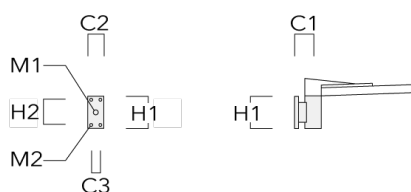

RV2-76 Pole bracket, double	108-0980		147				76 x 100					4.80	147	76	200
-----------------------------	----------	--	-----	--	--	--	----------	--	--	--	--	------	-----	----	-----

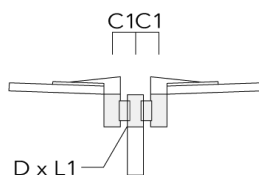

VFL530 LED

Pole mounted

Description	Part ID	Additional information	C1	C2	C3	D1	D × L1	H1	H2	M1	M2	Weight (kg)	C	D	H
RV2-60 Pole bracket, double	108-0981	147					60 x 100					4.80	147	60	200

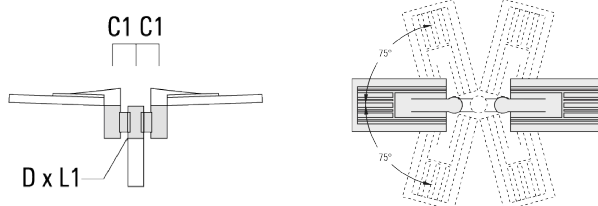

RV5 Pole bracket	108-0982	108				76-240						1.70	106	200
------------------	----------	-----	--	--	--	--------	--	--	--	--	--	------	-----	-----

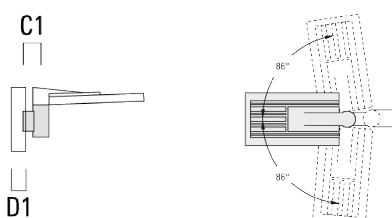

VFL530 LED

Pole mounted

we-ef

Post top fitter AKV

Description	Part ID	C1	D × L1	D × L2	H1	Weight (kg)
AKV2-76	300-0053	180	76x100	76x80	235	1.50

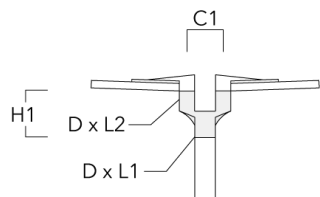

Optical Accessories**Light shield**

Description	Part ID	Additional information
LS180-[A60]	430-0038	Light shield LS180 to greatly reduce or eliminate light pollution. PA injection moulded component, black matt. Suitable for asymmetric light distribution [A60].
LS180	430-0029	Glare Shield for backlight spill. Glare Shield factory-installed or available as retrofit kit. Suitable for [S60], [S65], [S70], [R65], [P65] lenses. Must be specified at time of ordering.