

# DLG229 LED

Wall luminaires surface mounted

**we-ef**

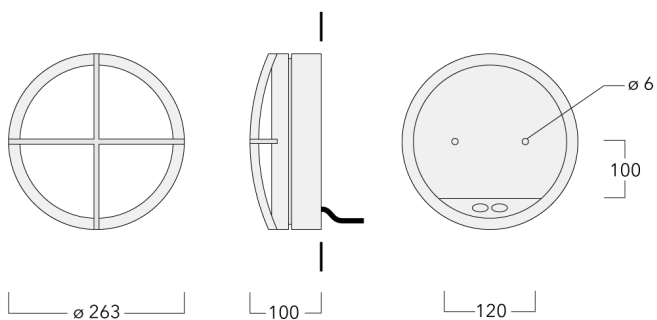

## Description

IP55, Class I. Class II on request. IK10. Marine-grade, die-cast aluminium alloy. 5CE superior corrosion protection including PCS hardware. Silicone rubber gasket. Polycarbonate main lens. Two cable entries. Factory installed LED circuit board. Integral EC electronic converter.

## Fagerhult Lighting Ltd





33-34 Dolben Street, SE1 0UQ London, United Kingdom

<https://we-ef.com/uk>

Subject to technical changes and errors. - Generated on 23/11/2024

**Wall luminaires surface mounted****Specifications****Material description**

---

Body	Marine-grade die-cast aluminium alloy
Lens	Polycarbonate lens
Colours	 RAL9004 Signal black  RAL9006 White aluminium  RAL9007 Grey aluminium  RAL7016 Anthracite grey  RAL9016 Traffic white
Gasket	Silicone rubber gasket
Fasteners	PCS Polymer Coated Stainless Steel Hardware
Ingress protection	IP55
Impact resistance	IK10
Corrosion resistance	5CE

---

**Electrical description**

---

Power supply	220-240V / 50-60 Hz
Driver / Ballast	Integral EC electronic converter
Surge protection	1/2 kV

---

**Additional information**

---

Lifetime	Ta=25° L70B50 > 50000h
Energy efficiency class	E (Light source)

---

# DLG229 LED

Wall luminaires surface mounted

## Options

### Light distribution



diffused distribution

### Colour temperature



3000 K



4000 K



2700 K

### Nominal Watt

15 W

# DLG229 LED

Wall luminaires surface mounted

## Configurations

Light distribution	Part ID	Light source	Rated lumens	Rated input power	CRI	Weight (kg)
diffused distribution 	195-0895	LED-FT-17W / 500 mA - 2700 K	1153.5	20 W	80	2.10
	195-9524	LED-FT-17W / 500 mA - 3000 K	1206.5	20 W	80	2.10
	195-9525	LED-FT-17W / 500 mA - 4000 K	1257.6	20 W	80	2.10