

DLS229 LED

Wall luminaires surface mounted

we-ef



Description

IP55, Class I. Class II on request. IK10. Marine-grade, die-cast aluminium alloy. 5CE superior corrosion protection including PCS hardware. Silicone rubber gasket. Polycarbonate main lens. Two cable entries. Factory installed LED circuit board. Integral EC electronic converter.

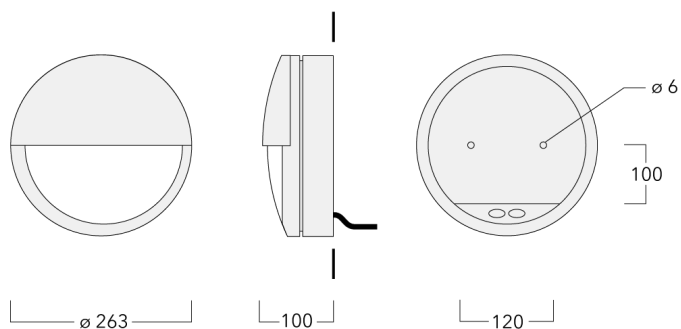





WE-EF LEUCHTEN GmbH

Töpinger Straße 16, 29646 Bispingen, Germany - Phone: +49 5194 909-0

info@we-ef.com - <https://we-ef.com>

Subject to technical changes and errors. - Generated on 23/10/2024

Wall luminaires surface mounted**Specifications****Material description**

Body	Marine-grade die-cast aluminium alloy
Lens	Polycarbonate main lens
Colours	 RAL9004 Signal black  RAL9006 White aluminium  RAL9007 Grey aluminium  RAL7016 Anthracite grey  RAL9016 Traffic white
Gasket	Silicone rubber gasket
Fasteners	PCS Polymer Coated Stainless Steel Hardware
Ingress protection	IP55
Impact resistance	IK10
Corrosion resistance	5CE

Electrical description

Power supply	220-240V / 50-60 Hz
Driver / Ballast	Integral EC electronic converter
Surge protection	1/2 kV

Additional information

Lifetime	Ta=25° L70B50 > 50000h
----------	------------------------

DLS229 LED

Wall luminaires surface mounted

Options

Light distribution



diffused distribution

Colour temperature



3000 K



4000 K



2700 K

Nominal Watt

15 W

DLS229 LED

Wall luminaires surface mounted

Configurations

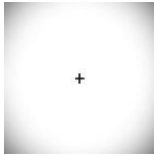
Light distribution	Part ID	Light source	Rated lumens	Rated input power	CRI	Weight (kg)
diffused distribution 	195-0897	LED-FT-17W / 500 mA - 2700 K	931.6	20 W	80	2.20
	195-9527	LED-FT-17W / 500 mA - 3000 K	974.4	20 W	80	2.20
	195-9528	LED-FT-17W / 500 mA - 4000 K	1015.7	20 W	80	2.20

DLS229 LED

Wall luminaires surface mounted

WE-EF LEUCHTEN GmbH

Töpinger Straße 16, 29646 Bispingen, Germany

Phone: +49 5194 909-0

info@we-ef.com

<https://we-ef.com>

Subject to technical changes and errors.

Generated on 23/10/2024