



Description

IP66, Class I. IK07. Marine-grade, die-cast aluminium alloy. 5CE superior corrosion protection + primer including PCS hardware. Safety glass lens. Silicone CCG® Controlled Compression Gasket. Luminaire is factory-sealed and does not need to be opened during installation.

Integral EC electronic converter in thermally-separated compartment. Advanced thermal management protects LEDs while optimising lumens output. CAD-optimised optics for superior illumination and glare control. OLC® One LED Concept.



Including 0.4 m of flexible cable enclosed in a stainless conduit, in-line connector and mounting clamp for installation to RAIL66 mounting system.

2700 K option available on request.

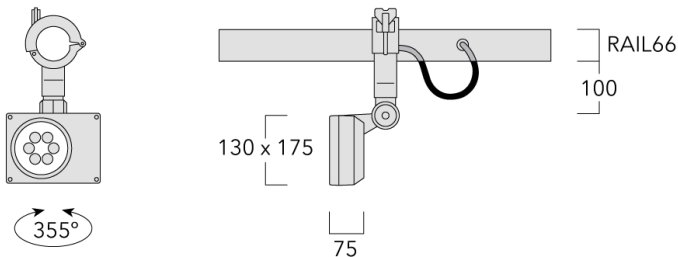
If ordering a fitting to be installed on an existing rail, please confirm the rail version with your local distributor or our customer excellence team as connectors vary.



Specifications**Material description**

Body	Marine-grade, die-cast aluminium alloy
Lens	Safety glass lens
Colours	 RAL9004 Signal black  RAL9006 White aluminium  RAL9007 Grey aluminium
Gasket	Silicone CCG® Controlled Compression Gasket
Fasteners	PCS Polymer Coated Stainless Steel Hardware (unpainted)
Ingress protection	IP66
Impact resistance	IK07
Corrosion resistance	5CE+Primer

Electrical description

Power supply	230V / 50 Hz
Driver / Ballast	Integral EC electronic converter in thermally-separated compartment

Additional information

Lifetime	Ta=40° L90B10 > 90000h
Warranty	The product is supplied with 10-year warranty. Please refer to the LED Warranty Statement located on www.we-ef.com for further details.

Options

Light distribution



symmetric, medium beam [M]



symmetric, wide beam [B]



symmetric, very narrow beam [EE]



symmetric, very narrow beam, sharp cut-off [EES]



wallwash

Colour temperature



3000 K







4000 K

Nominal Watt

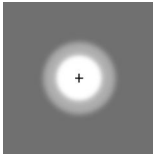
16 W

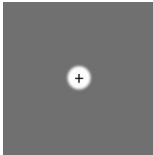
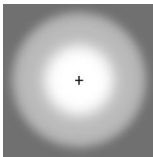
Configurations

Light distribution	Part ID	Light source	Rated lumens	Rated input power	CRI	Weight (kg)
symmetric, medium beam [M] 	145-9509	LED-6/12W / 700 mA - 3000 K	1454.1	14.5 W	80	2.60
	145-9510	LED-6/12W / 700 mA - 4000 K	1554.3	14.5 W	80	2.60
symmetric, very narrow beam [EE] 	145-9513	LED-6/12W / 700 mA - 3000 K	1393.4	14.5 W	80	2.60
	145-9514	LED-6/12W / 700 mA - 4000 K	1489.5	14.5 W	80	2.60
symmetric, very narrow beam, sharp cut-off [EES] 	145-9515	LED-6/12W / 700 mA - 3000 K	1492.9	14.5 W	80	2.60
	145-9516	LED-6/12W / 700 mA - 4000 K	1595.9	14.5 W	80	2.60
symmetric, wide beam [B] 	145-9511	LED-6/12W / 700 mA - 3000 K	1148.3	14.5 W	80	2.60
	145-9512	LED-6/12W / 700 mA - 4000 K	1227.5	14.5 W	80	2.60
wallwash 	145-9509+145-9479	LED-6/12W / 700 mA - 3000 K	1142.4	14.5 W	80	2.60
	145-9510+145-9479	LED-6/12W / 700 mA - 4000 K	1221.2	14.5 W	80	2.60

Optical Accessories

Wallwash lens

Description	Part ID	C1
Wallwash lens IO-20	145-9479	97

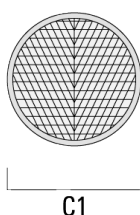

Optical Adaptor

Description	Part ID	A	C1
External optical adaptor EA	145-9530	57	109

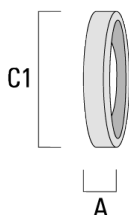

RAIL66**Glare shield**

Description	Part ID	A	C1
Glare shield ES	145-9531	57	109

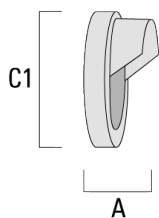

Snoot

Description	Part ID	A	C1
Snoot ET	145-9532	57	109

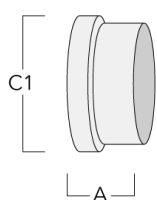

RAIL66

Linear spread lens

Description	Part ID	C1
E0-180	145-9533	101

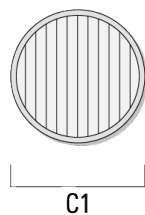

Surface wash lens

Description	Part ID	C1
E0-360	145-9534	101

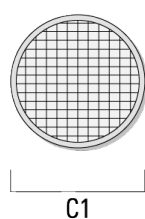

Mounting Accessories

Universal

Description	Part ID	C1	C2	H1	M1	Weight (kg)	L1	L2
2 Mains outlets (L=1150)	310-9200	75	30	200	12	5.90	1150	1045

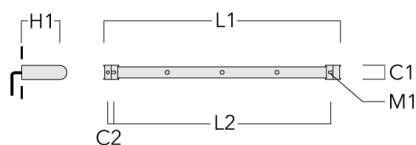

3 Mains outlets (L=1150)	310-9202	75	30	200	12	5.90	1150	1045
--------------------------	----------	----	----	-----	----	------	------	------

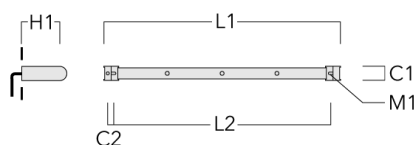

RAIL66

Description	Part ID	C1	C2	H1	M1	Weight (kg)	L1	L2
3 Mains outlets (L=1650)	310-9210	75	30	200	12	7.20	1650	1545

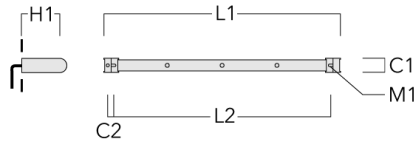

4 Mains outlets (L=1650)	310-9212	75	30	200	12	7.20	1650	1545
--------------------------	----------	----	----	-----	----	------	------	------

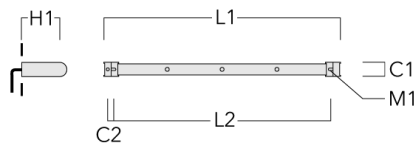

RAIL66

Description	Part ID	C1	C2	H1	M1	Weight (kg)	L1	L2
4 Mains outlets (L=2150)	310-9220	75	30	200	12	8.50	2150	2045

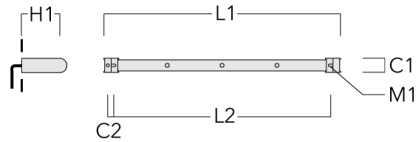

6 Mains outlets (L=2150)	310-9222	75	30	200	12	8.50	2150	2045
--------------------------	----------	----	----	-----	----	------	------	------

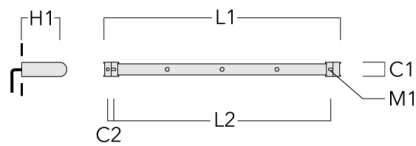

RAIL66

Flat Surface Fitters

Description	Part ID	C1	C2	D1	D2	L	M1	Weight (kg)
Surface fitters (pair)	310-9290	20	30	180	140	1070	9	1.70

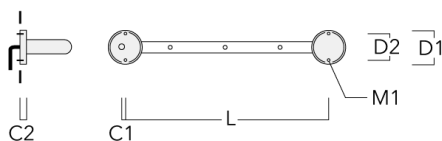

Column Fitters

Description	Part ID	C1	C2	L	M1	Weight (kg)
Column fitters (pair)	310-9294	30	100	1115	12	0.90

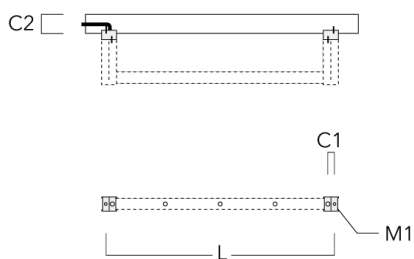

RAIL66

Cantilever

Description	Part ID	C1	C2	C3	H1	M1	Weight (kg)	L1	L2
2 Mains outlets (L=1150)	310-9230	220	120	60	600	13	12	1150	1070

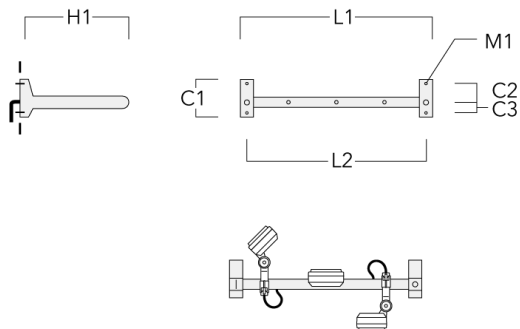

3 Mains outlets (L=1150)	310-9232	220	120	60	600	13	12	1150	1070
--------------------------	----------	-----	-----	----	-----	----	----	------	------

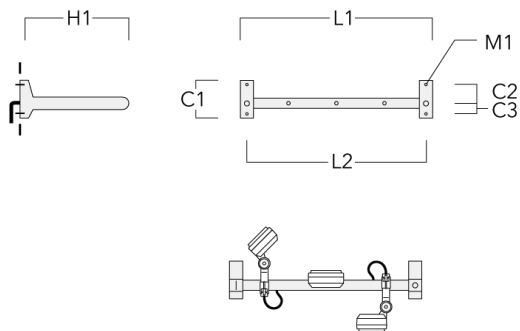

RAIL66

Description	Part ID	C1	C2	C3	H1	M1	Weight (kg)	L1	L2
3 Mains outlets (L=1650)	310-9240	220	120	60	600	13	13.30	1650	1570

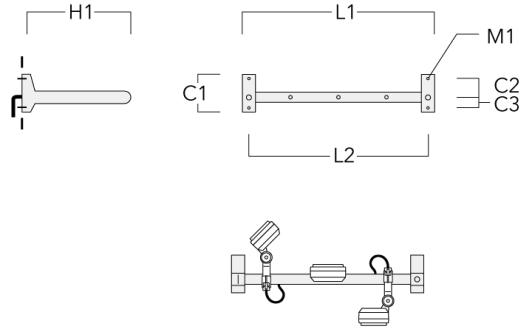

4 Mains outlets (L=1650)	310-9242	220	120	60	600	13	13.30	1650	1570
--------------------------	----------	-----	-----	----	-----	----	-------	------	------

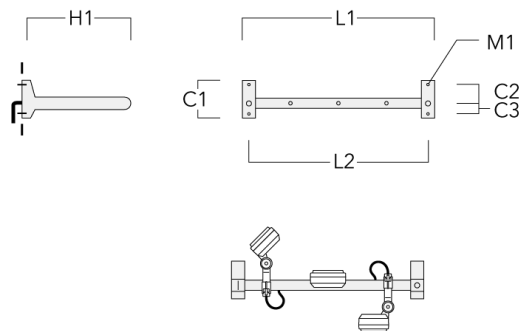

RAIL66

Description	Part ID	C1	C2	C3	H1	M1	Weight (kg)	L1	L2
4 Mains outlets (L=2150)	310-9250	220	120	60	600	13	14.60	2150	2070

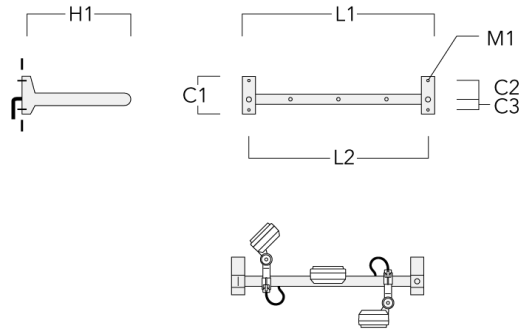

6 Mains outlets (L=2150)	310-9252	220	120	60	600	13	14.60	2150	2070
--------------------------	----------	-----	-----	----	-----	----	-------	------	------

