

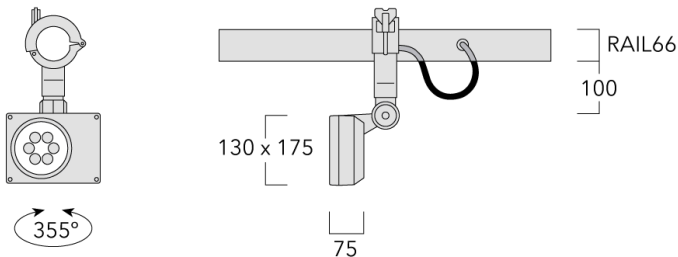







Description

IP66, Class I. IK07. Marine-grade, die-cast aluminium alloy. 5CE superior corrosion protection including PCS hardware. Silicone CCG® Controlled Compression Gasket. Safety glass lens. Integral EC electronic converter in thermally separated compartment. CAD-optimised optics for superior illumination and glare control. OLC® One LED Concept. Factory installed LED circuit board.

Including 0,4 m of flexible cable enclosed in stainless conduit, in-line connector and mounting clamp for installation to RAIL66 mounting system.



Specifications**Material description**

Body	Marine-grade, die-cast aluminium alloy
Lens	Safety glass lens
Colours	 RAL9004 Signal black  RAL9006 White aluminium  RAL9007 Grey aluminium  RAL7016 Anthracite grey  RAL9016 Traffic white
Gasket	Silicone rubber gasket
Fasteners	PCS Polymer Coated Stainless Steel Hardware
Ingress protection	IP66
Impact resistance	IK07
Corrosion resistance	5CE

Electrical description

Power supply	220-240V / 50-60 Hz
Driver / Ballast	Integral EC electronic converter in thermally-separated compartment
Surge protection	1/2 kV

Additional information

Lifetime	Ta=25° L90B10 > 90000h
Energy efficiency class	C-D (Light source)

FLD121 LED RAIL66

RAIL66

Options

Light distribution



symmetric, medium beam [M]



symmetric, wide beam [B]



symmetric, very narrow beam [EE]



symmetric, very narrow beam, sharp cut-off [EES]



wallwash [A20]

Colour temperature



3000 K







4000 K

Nominal Watt

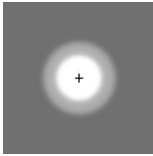
16 W

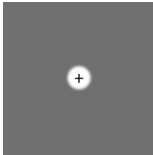
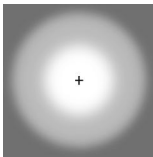
Configurations

Light distribution	Part ID	Light source	Rated lumens	Rated input power	CRI	Weight (kg)
symmetric, medium beam [M] 	145-9509	LED-6/12W / 700 mA - 3000 K	1454.1	14.5 W	80	2.60
	145-9510	LED-6/12W / 700 mA - 4000 K	1554.3	14.5 W	80	2.60
symmetric, very narrow beam [EE] 	145-9513	LED-6/12W / 700 mA - 3000 K	1393.4	14.5 W	80	2.60
	145-9514	LED-6/12W / 700 mA - 4000 K	1489.5	14.5 W	80	2.60
symmetric, very narrow beam, sharp cut-off [EES] 	145-9515	LED-6/12W / 700 mA - 3000 K	1492.9	14.5 W	80	2.60
	145-9516	LED-6/12W / 700 mA - 4000 K	1595.9	14.5 W	80	2.60
symmetric, wide beam [B] 	145-9511	LED-6/12W / 700 mA - 3000 K	1148.3	14.5 W	80	2.60
	145-9512	LED-6/12W / 700 mA - 4000 K	1227.5	14.5 W	80	2.60
wallwash [A20] 	145-0245	LED-6/12W / 700 mA - 3000 K	1142.4	14.5 W	80	2.60
	145-0246	LED-6/12W / 700 mA - 4000 K	1221.2	14.5 W	80	2.60

Optical Accessories

Glare shield

Description	Part ID	A	C1
Glare shield ES	145-9531	57	109

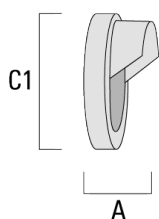

Snoot

Description	Part ID	A	C1
Snoot ET	145-9532	57	109

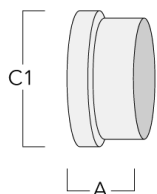

Linear spread lens

Fagerhult Lighting Ltd

33-34 Dolben Street, SE1 0UQ London, United Kingdom

<https://we-ef.com/uk>

Subject to technical changes and errors. - Generated on 23/10/2024

FLD121 LED RAIL66

RAIL66

Description	Part ID	C1
IO-180-FLD121-LED	145-9480	97

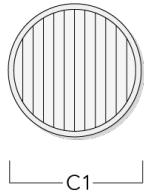

Flood lens

Description	Part ID	C1
IO-360-FLD121-LED	145-9481	97

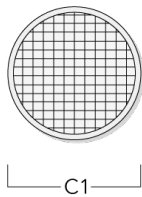

Mounting Accessories

Universal

Description	Part ID	C1	C2	H1	M1	Weight (kg)	L1	L2
2 Mains outlets (L=1150)	310-9200	75	30	200	12	5.90	1150	1045

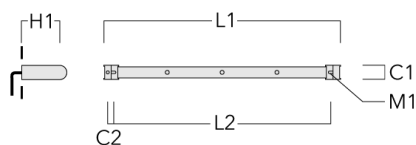

3 Mains outlets (L=1150)	310-9202	75	30	200	12	5.90	1150	1045
--------------------------	----------	----	----	-----	----	------	------	------

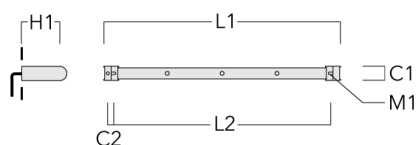

RAIL66

Description	Part ID	C1	C2	H1	M1	Weight (kg)	L1	L2
3 Mains outlets (L=1650)	310-9210	75	30	200	12	7.20	1650	1545

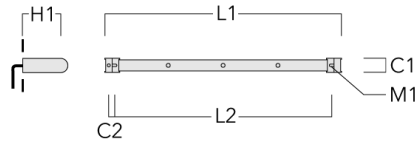

4 Mains outlets (L=1650)	310-9212	75	30	200	12	7.20	1650	1545
--------------------------	----------	----	----	-----	----	------	------	------

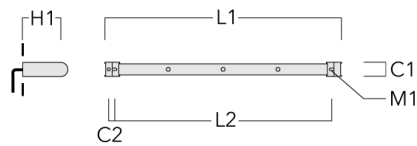

RAIL66

Description	Part ID	C1	C2	H1	M1	Weight (kg)	L1	L2
4 Mains outlets (L=2150)	310-9220	75	30	200	12	8.50	2150	2045

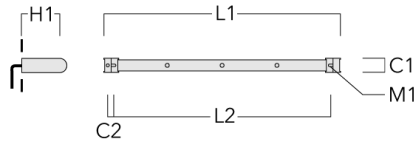

6 Mains outlets (L=2150)	310-9222	75	30	200	12	8.50	2150	2045
--------------------------	----------	----	----	-----	----	------	------	------

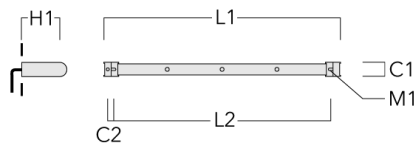

Flat Surface Fitters

Fagerhult Lighting Ltd

33-34 Dolben Street, SE1 0UQ London, United Kingdom

<https://we-ef.com/uk>

Subject to technical changes and errors. - Generated on 23/10/2024

RAIL66

Description	Part ID	C1	C2	D1	D2	L	M1	Weight (kg)
Surface fitters (pair)	310-9290	20	30	180	140	1070	9	1.70

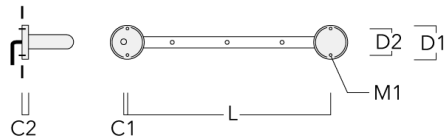

Column Fitters

Description	Part ID	C1	C2	L	M1	Weight (kg)
Column fitters (pair)	310-9294	30	100	1115	12	0.90

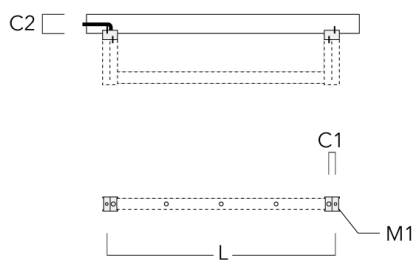

Cantilever

Fagerhult Lighting Ltd

33-34 Dolben Street, SE1 0UQ London, United Kingdom

<https://we-ef.com/uk>

Subject to technical changes and errors. - Generated on 23/10/2024

RAIL66

Description	Part ID	C1	C2	C3	H1	M1	Weight (kg)	L1	L2
2 Mains outlets (L=1150)	310-9230	220	120	60	600	13	12	1150	1070

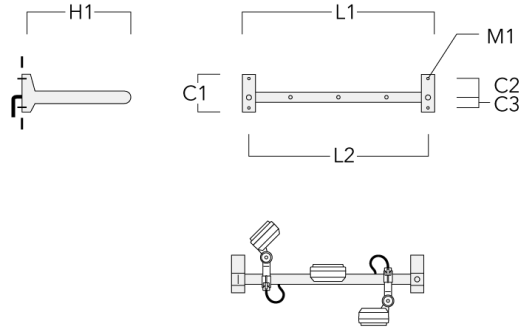

3 Mains outlets (L=1150)	310-9232	220	120	60	600	13	12	1150	1070
--------------------------	----------	-----	-----	----	-----	----	----	------	------

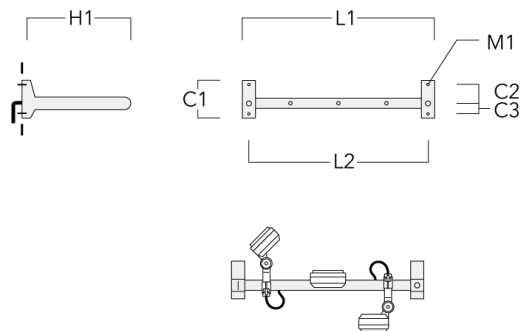

RAIL66

Description	Part ID	C1	C2	C3	H1	M1	Weight (kg)	L1	L2
3 Mains outlets (L=1650)	310-9240	220	120	60	600	13	13.30	1650	1570

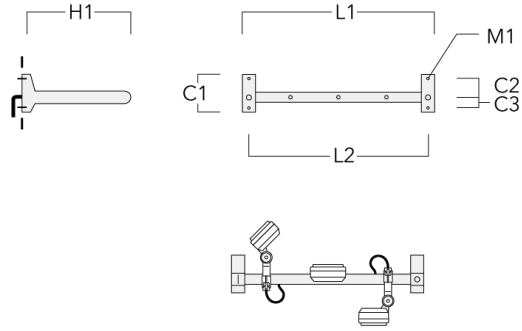

4 Mains outlets (L=1650)	310-9242	220	120	60	600	13	13.30	1650	1570
--------------------------	----------	-----	-----	----	-----	----	-------	------	------

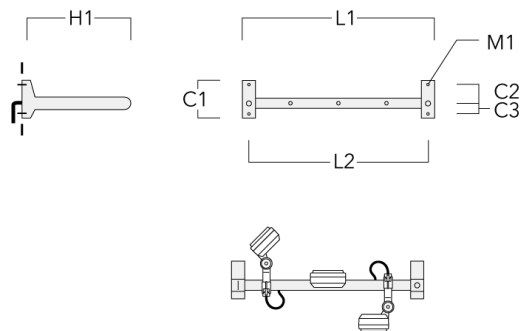

RAIL66

Description	Part ID	C1	C2	C3	H1	M1	Weight (kg)	L1	L2
4 Mains outlets (L=2150)	310-9250	220	120	60	600	13	14.60	2150	2070

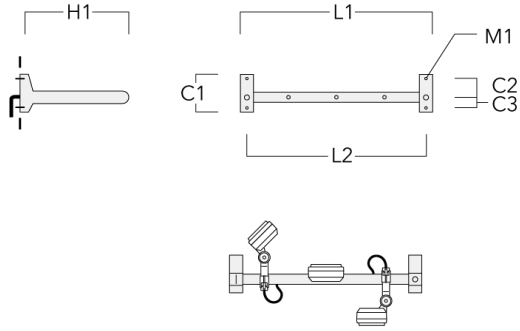

6 Mains outlets (L=2150)	310-9252	220	120	60	600	13	14.60	2150	2070
--------------------------	----------	-----	-----	----	-----	----	-------	------	------

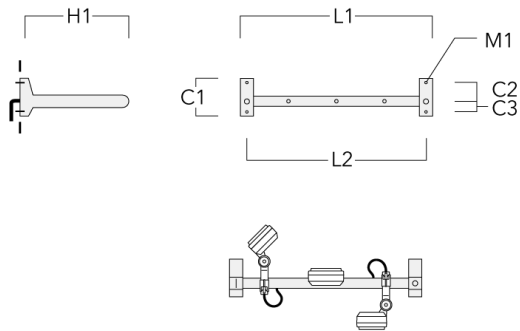

FLD121 LED RAIL66

RAIL66

Fagerhult Lighting Ltd

33-34 Dolben Street, SE1 0UQ London, United Kingdom

<https://we-ef.com/uk>

Subject to technical changes and errors.

Generated on 23/10/2024