

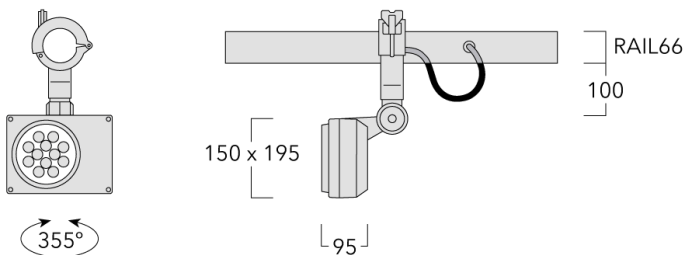







Description

IP66, Class I. IK07. Marine-grade, die-cast aluminium alloy. 5CE superior corrosion protection including PCS hardware. Silicone CCG® Controlled Compression Gasket. Safety glass lens. Integral EC electronic converter in thermally separated compartment. CAD-optimised optics for superior illumination and glare control. OLC® One LED Concept. Factory installed LED circuit board.

Including 0,4 m of flexible cable enclosed in stainless conduit, in-line connector and mounting clamp for installation to RAIL66 mounting system.



Specifications**Material description**

Body	Marine-grade, die-cast aluminium alloy
Lens	Safety glass lens
Colours	 RAL9004 Signal black  RAL9006 White aluminium  RAL9007 Grey aluminium  RAL7016 Anthracite grey  RAL9016 Traffic white
Gasket	Silicone rubber gasket
Fasteners	PCS Polymer Coated Stainless Steel Hardware
Ingress protection	IP66
Impact resistance	IK07
Corrosion resistance	5CE

Electrical description

Power supply	220-240V / 50-60 Hz
Driver / Ballast	Integral EC electronic converter in thermally-separated compartment
Surge protection	1/2 kV

Additional information

Lifetime	Ta=25° L90B10 > 90000h
Energy efficiency class	C-D (Light source)

FLD131 LED RAIL66

RAIL66

we-ef

Options

Light distribution



symmetric, medium beam [M]



symmetric, very narrow beam [EE]



symmetric, wide beam [B]



symmetric, very narrow beam, sharp cut-off [EES]



wallwash [A20]

Colour temperature



3000 K







4000 K

Nominal Watt

3 W

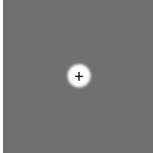
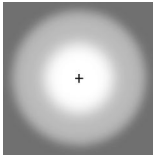
Configurations

Light distribution	Part ID	Light source	Rated lumens	Rated input power	CRI	Weight (kg)
symmetric, medium beam [M] 	145-9556	LED-12/24W / 700 mA - 3000 K	2908.1	27 W	80	3.00
	145-9559	LED-12/24W / 700 mA - 4000 K	3108.7	27 W	80	3.00
symmetric, very narrow beam [EE] 	145-9557	LED-12/24W / 700 mA - 3000 K	2786.9	27 W	80	3.00
	145-9560	LED-12/24W / 700 mA - 4000 K	2979.1	27 W	80	3.00
symmetric, very narrow beam, sharp cut-off [EES] 	145-9609	LED-12/24W / 700 mA - 3000 K	2985.8	27 W	80	3.60
	145-9611	LED-12/24W / 700 mA - 4000 K	3191.8	27 W	80	3.00
symmetric, wide beam [B] 	145-9608	LED-12/24W / 700 mA - 3000 K	2296.7	27 W	80	3.00
	145-9610	LED-12/24W / 700 mA - 4000 K	2455	27 W	80	3.00
wallwash [A20] 	145-0241	LED-12/24W / 700 mA - 3000 K	2284.9	27 W	80	3.00
	145-0242	LED-12/24W / 700 mA - 4000 K	2442.4	27 W	80	3.00

Optical Accessories

Glare shield

Description	Part ID	A	C1
Glare shield ES	145-9571	70	134

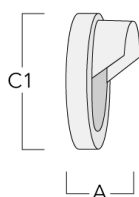

Snoot

Description	Part ID	A	C1
Snoot ET	145-9572	70	134

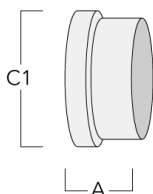

RAIL66

Linear spread lens

Description	Part ID	C1
IO-180-FLD131-LED	145-9575	125

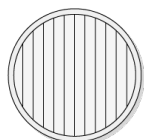

C1

Flood lens

Description	Part ID	C1
IO-360-FLD131-LED	145-9576	125

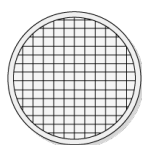

C1

Mounting Accessories

Universal

Description	Part ID	C1	C2	H1	M1	Weight (kg)	L1	L2
2 Mains outlets (L=1150)	310-9200	75	30	200	12	5.90	1150	1045

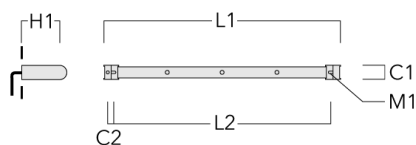

3 Mains outlets (L=1150)	310-9202	75	30	200	12	5.90	1150	1045
--------------------------	----------	----	----	-----	----	------	------	------

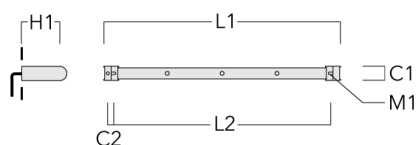

RAIL66

Description	Part ID	C1	C2	H1	M1	Weight (kg)	L1	L2
3 Mains outlets (L=1650)	310-9210	75	30	200	12	7.20	1650	1545

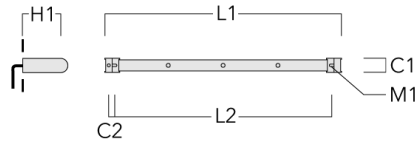

4 Mains outlets (L=1650)	310-9212	75	30	200	12	7.20	1650	1545
--------------------------	----------	----	----	-----	----	------	------	------

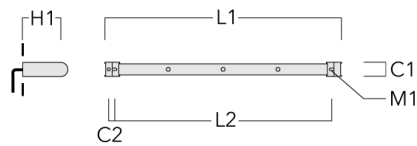

RAIL66

Description	Part ID	C1	C2	H1	M1	Weight (kg)	L1	L2
4 Mains outlets (L=2150)	310-9220	75	30	200	12	8.50	2150	2045

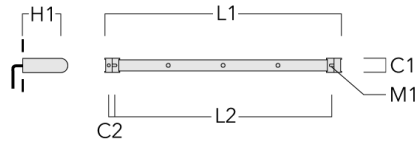

6 Mains outlets (L=2150)	310-9222	75	30	200	12	8.50	2150	2045
--------------------------	----------	----	----	-----	----	------	------	------

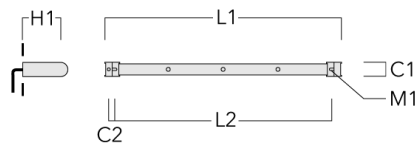

RAIL66

Flat Surface Fitters

Description	Part ID	C1	C2	D1	D2	L	M1	Weight (kg)
Surface fitters (pair)	310-9290	20	30	180	140	1070	9	1.70

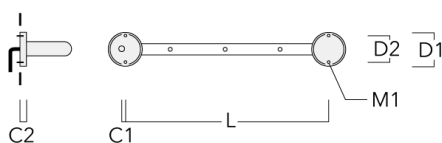

Column Fitters

Description	Part ID	C1	C2	L	M1	Weight (kg)
Column fitters (pair)	310-9294	30	100	1115	12	0.90

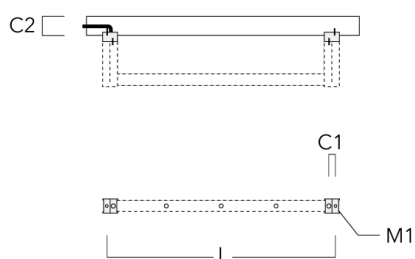

RAIL66

Cantilever

Description	Part ID	C1	C2	C3	H1	M1	Weight (kg)	L1	L2
2 Mains outlets (L=1150)	310-9230	220	120	60	600	13	12	1150	1070

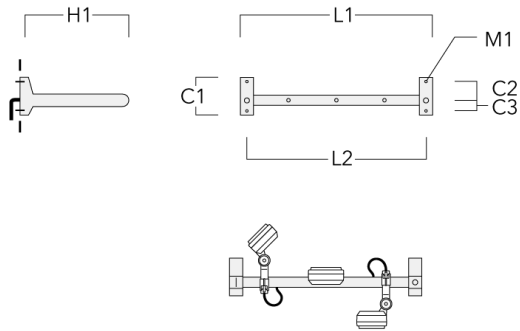

3 Mains outlets (L=1150)	310-9232	220	120	60	600	13	12	1150	1070
--------------------------	----------	-----	-----	----	-----	----	----	------	------

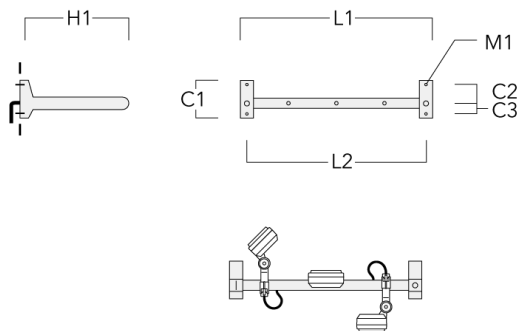

RAIL66

Description	Part ID	C1	C2	C3	H1	M1	Weight (kg)	L1	L2
3 Mains outlets (L=1650)	310-9240	220	120	60	600	13	13.30	1650	1570

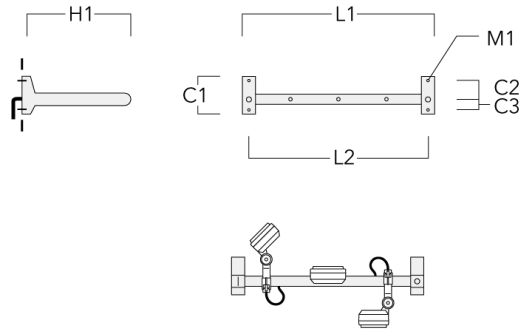

4 Mains outlets (L=1650)	310-9242	220	120	60	600	13	13.30	1650	1570
--------------------------	----------	-----	-----	----	-----	----	-------	------	------

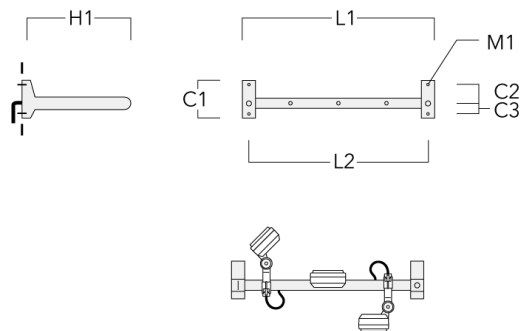

RAIL66

Description	Part ID	C1	C2	C3	H1	M1	Weight (kg)	L1	L2
4 Mains outlets (L=2150)	310-9250	220	120	60	600	13	14.60	2150	2070

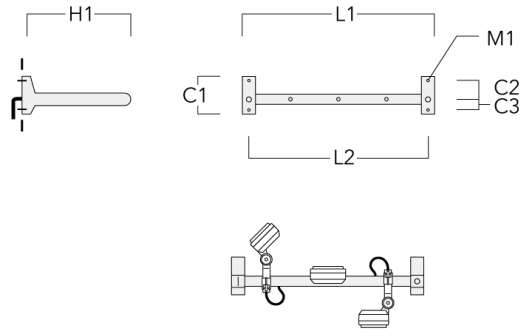

6 Mains outlets (L=2150)	310-9252	220	120	60	600	13	14.60	2150	2070
--------------------------	----------	-----	-----	----	-----	----	-------	------	------

