

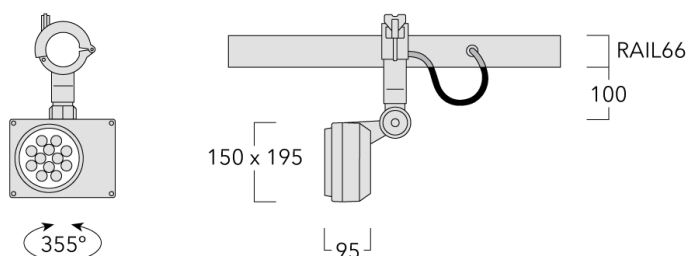

### Description





IP66. Classe I. IK07. Corps en fonte d'aluminium. Visserie inox avec traitement PCS. Protection contre la corrosion 5CE. Joint silicone. Verre de sécurité.

Alimentation électronique dans un boîtier thermique séparé. Livré avec 40cm de câble pour branchement direct sur notre système RAIL66.



**Spécifications****Description du matériel**

---

Corps	Corps en fonte d'aluminium
Lentille	Verre de sécurité
Couleurs	 RAL9004 Noir de sécurité  RAL9007 Aluminium gris  RAL7016 Gris anthracite  RAL9016 Blanc signalisation
Joint	Joint silicone
Visserie	PCS Inox avec recouvrement polymère
IP	IP66
IK	IK07
Protection contre la corrosion	5CE

---

**Description électrique**

---

Alimentation électrique	220-240V / 50-60 Hz
Driver	Driver électronique séparé thermiquement

---

**Informations complémentaires**

---

Durée de vie	Ta=25° L90B10 > 90000h
Classe d'efficacité énergétique	C-D

---

### Options

#### Distribution de la lumière



faisceau symétrique, médium [M]



faisceau symétrique, ultra intensif [EE]



faisceau symétrique, extensif [B]



faisceau symétrique, ultra intensif, 'cut-off' [EES]



wallwash [A20]

#### Température de couleur



3000 K





4000 K

#### Données en sortie de luminaire

3 W

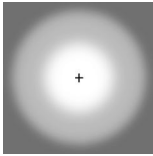
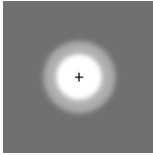
### Configurations

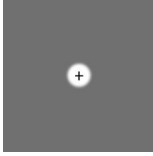
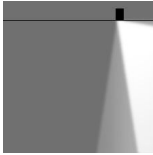
Distribution de la lumière	Référence	Source lumineuse	Rated lumens	Rated input power	IRC	Poids (kg)
faisceau symétrique, extensif [B] 	145-9608	LED-12/24W / 700 mA - 3000 K	2296.7	27 W	80	3.00
	145-9610	LED-12/24W / 700 mA - 4000 K	2455	27 W	80	3.00
faisceau symétrique, médium [M] 	145-9556	LED-12/24W / 700 mA - 3000 K	2908.1	27 W	80	3.00
	145-9559	LED-12/24W / 700 mA - 4000 K	3108.7	27 W	80	3.00
faisceau symétrique, ultra intensif [EE] 	145-9557	LED-12/24W / 700 mA - 3000 K	2786.9	27 W	80	3.00
	145-9560	LED-12/24W / 700 mA - 4000 K	2979.1	27 W	80	3.00
faisceau symétrique, ultra intensif, 'cut-off' [EES] 	145-9609	LED-12/24W / 700 mA - 3000 K	2985.8	27 W	80	3.60
	145-9611	LED-12/24W / 700 mA - 4000 K	3191.8	27 W	80	3.00
wallwash [A20] 	145-0241	LED-12/24W / 700 mA - 3000 K	2284.9	27 W	80	3.00
	145-0242	LED-12/24W / 700 mA - 4000 K	2442.4	27 W	80	3.00

**Accessoires Optiques****Visière**

Description	Référence	A	C1
Visière ES	145-9571	70	134

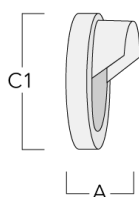
**Lentille ovalisante**

Description	Référence	C1
IO-180-FLD131-LED	145-9575	125

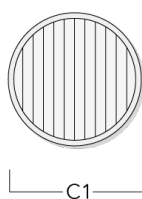

### Lentille élargissante

Description	Référence	C1
IO-360-FLD131-LED	145-9481	125

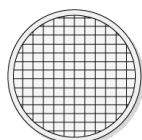

C1

### Accessoires d'installation

#### Universal

Description	Référence	C1	C2	H1	M1	Poids (kg)	L1	L2
Rail 66 système universel pour 2 projecteurs maxi (L=1150)	310-9200	75	30	200	12	5.90	1150	1045

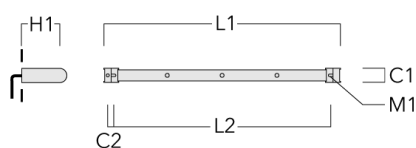

Rail 66 système universel pour 3 projecteurs maxi (L=1150)	310-9202	75	30	200	12	5.90	1150	1045
--	----------	----	----	-----	----	------	------	------

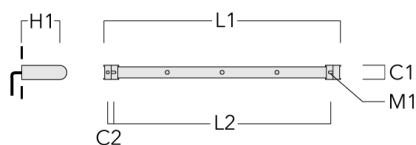

## RAIL66

Description	Référence	C1	C2	H1	M1	Poids (kg)	L1	L2
Rail 66 système universel pour 3 projecteurs maxi (L=1650)	310-9210	75	30	200	12	7.20	1650	1545

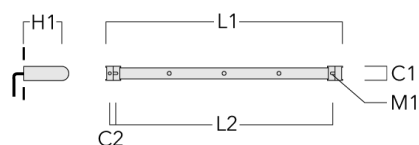

Rail 66 système universel pour 4 projecteurs maxi (L=1650)	310-9212	75	30	200	12	7.20	1650	1545
--	----------	----	----	-----	----	------	------	------

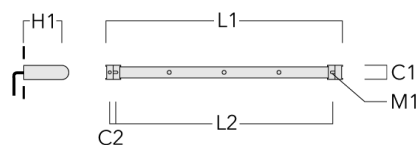



## RAIL66

Description	Référence	C1	C2	H1	M1	Poids (kg)	L1	L2
Rail 66 système universel pour 4 projecteurs maxi (L=2150)	310-9220	75	30	200	12	8.50	2150	2045

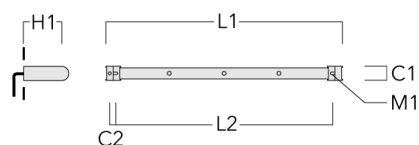

Rail 66 système universel pour 6 projecteurs maxi (L=2150)	310-9222	75	30	200	12	8.50	2150	2045
--	----------	----	----	-----	----	------	------	------

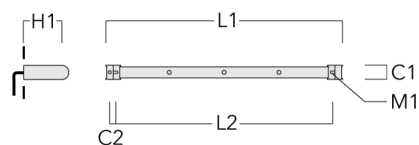

## RAIL66

### Cache (paire)

Description	Référence	C1	C2	D1	D2	L	M1	Poids (kg)
Paire de cache pour rail66	310-9290	20	30	180	140	1070	9	1.70

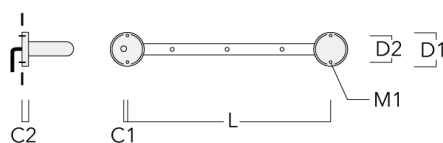

### Adaptateur pour fixation

Description	Référence	C1	C2	L	M1	Poids (kg)
Adaptateur pour fixation (paire)	310-9294	30	100	1115	12	0.90

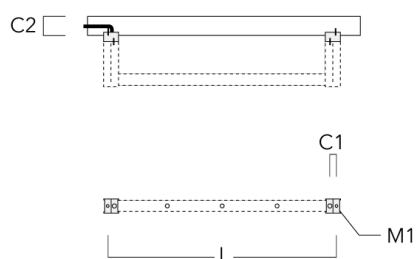

## RAIL66

### Crosse

Description	Référence	C1	C2	C3	H1	M1	Poids (kg)	L1	L2
Rail 66 crosse pour 2 projecteurs maxi (L=1150)	310-9230	220	120	60	600	13	12	1150	1070

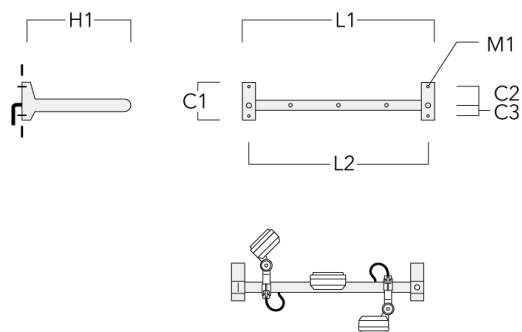

Rail 66 crosse pour 3 projecteurs maxi (L=1150)	310-9232	220	120	60	600	13	12	1150	1070
--	----------	-----	-----	----	-----	----	----	------	------

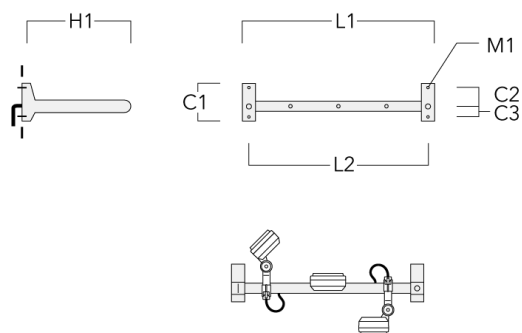

## RAIL66

Description	Référence	C1	C2	C3	H1	M1	Poids (kg)	L1	L2
Rail 66 crosse pour 3 projecteurs maxi (L=1650)	310-9240	220	120	60	600	13	13.30	1650	1570

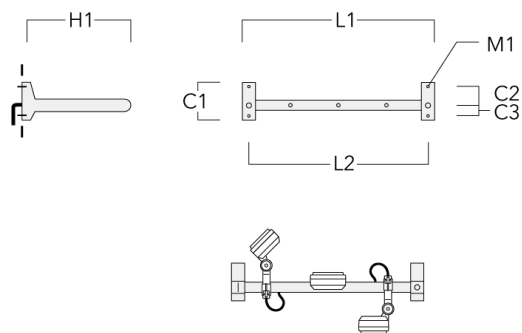

Rail 66 crosse pour 4 projecteurs maxi (L=1650)	310-9242	220	120	60	600	13	13.30	1650	1570
--	----------	-----	-----	----	-----	----	-------	------	------

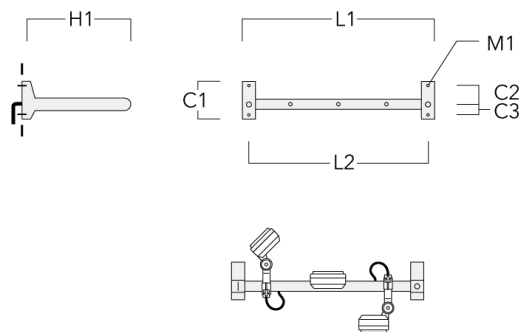

## RAIL66

Description	Référence	C1	C2	C3	H1	M1	Poids (kg)	L1	L2
Rail 66 crosse pour 4 projecteurs maxi (L=2150)	310-9250	220	120	60	600	13	14.60	2150	2070

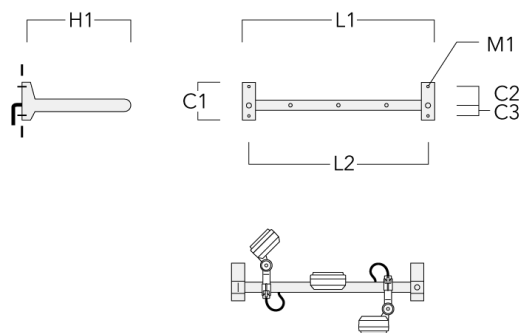

Rail 66 crosse pour 6 projecteurs maxi (L=2150)	310-9252	220	120	60	600	13	14.60	2150	2070
--	----------	-----	-----	----	-----	----	-------	------	------

