

VFL530-SE LED

Pole mounted

we-ef

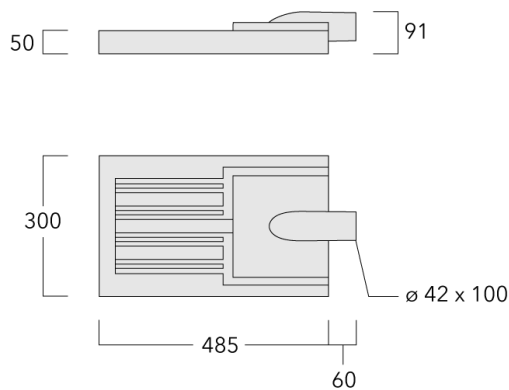

Description

IP66, Class I or Class II. IK08. Marine-grade, die-cast aluminium alloy. 5CE superior corrosion protection including PCS hardware. Silicone CCG® Controlled Compression Gasket. RFC® Reflection Free Contour main lens. Integral EC electronic converter in thermally separated compartment. DALI. CAD-optimised optics for superior illumination and glare control. OLC® One LED Concept. Factory installed LED circuit board. The luminaire is factory-sealed and does not need to be opened during installation.

Variant with 2200 K or as 'Wild-Light' 2200 K combined with 3000 K with Eco Step Dim® Advanced or Motion available on request, must be specified at time of ordering. For further details and available variants see below under additional information - Wild-Light Presentation.

Contact WE-EF direct or your local WE-EF sales representative for an individual solution designed to precisely meet your needs.





Fagerhult Lighting Ltd

33-34 Dolben Street, SE1 0UQ London, United Kingdom

<https://we-ef.com/uk>

Subject to technical changes and errors. - Generated on 23/11/2024

Pole mounted**Specifications****Material description**

Body	Marine-grade, die-cast aluminium alloy
Lens	RFC® Reflection Free Contour technology
Colours	 RAL9004 Signal black  RAL9006 White aluminium  RAL9007 Grey aluminium  RAL7016 Anthracite grey  RAL9016 Traffic white
Gasket	Silicone CCG® Controlled Compression Gasket
Fasteners	PCS Polymer Coated Stainless Steel Hardware
Ingress protection	IP66
Impact resistance	IK08
Corrosion resistance	5CE
Windage	0.149 m ²

Electrical description

Power supply	220-240V / 50-60 Hz
Driver / Ballast	Integral EC electronic converter. DALI
Power factor	> 0.9
Surge protection	6/6 kV

Additional information

Lifetime	Ta=25° L90B10 > 90000h
Energy efficiency class	C-D (Light source)





VFL530-SE LED

Pole mounted

we-ef

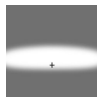
Options

Light distribution

	asymmetric, side throw beam [S60]
	asymmetric, side throw [S70]
	asymmetric, forward throw [A60]
	asymmetric, side throw beam [S65]
	rectangular, side throw [R65]
	pedestrian/bicycle lane [P65]

Colour temperature

	3000 K
	4000 K
	2700 K

Nominal Watt

58 W
29 W
15 W

Configurations

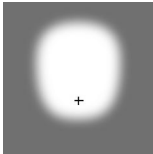
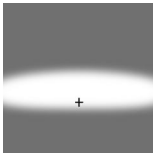
Light distribution	Part ID	Light source	Rated lumens	Rated input power	CRI	Weight (kg)
asymmetric, forward throw [A60] 	108-1291	LED-24/48W / 700 mA - 3000 K	5665.3	54 W	80	5.80
	108-1291-70	LED-24/48W / 700 mA - 3000 K	6446.7	54 W	70	5.80
	108-1292	LED-24/48W / 700 mA - 4000 K	6056	54 W	80	5.80
	108-1292-70	LED-24/48W / 700 mA - 4000 K	6837.4	54 W	70	5.80
	108-1301	LED-12/24W / 700 mA - 3000 K	2832.7	27 W	80	5.60
	108-1301-70	LED-12/24W / 700 mA - 3000 K	3223.4	27 W	70	5.60
	108-1302	LED-12/24W / 700 mA - 4000 K	3028	27 W	80	5.60
	108-1302-70	LED-12/24W / 700 mA - 4000 K	3418.7	27 W	70	5.60
	108-1311	LED-24/24W / 350 mA - 3000 K	3179.4	26.5 W	80	5.80
	108-1311-70	LED-24/24W / 350 mA - 3000 K	3692.2	26.5 W	70	5.80
	108-1312	LED-24/24W / 350 mA - 4000 K	3487	26.5 W	80	5.80
	108-1312-70	LED-24/24W / 350 mA - 4000 K	3897.3	26.5 W	70	5.80
	108-1321	LED-12/12W / 350 mA - 3000 K	1589.7	13.9 W	80	5.60
	108-1321-70	LED-12/12W / 350 mA - 3000 K	1846.1	13.9 W	70	5.60
	108-1322	LED-12/12W / 350 mA - 4000 K	1743.5	13.9 W	80	5.60
	108-1322-70	LED-12/12W / 350 mA - 4000 K	1948.6	13.9 W	70	5.60
	108-2052	LED-24/72W / 1050 mA - 3000 K	8909.1	81 W	80	5.60
	108-2052-70	LED-24/72W / 1050 mA - 3000 K	10152.2	81 W	70	5.60
	108-2053	LED-24/72W / 1050 mA - 4000 K	9323.5	81 W	80	5.60
	108-2053-70	LED-24/72W / 1050 mA - 4000 K	10566.6	81 W	70	5.60
	108-2412	LED-12/12W / 350 mA - 2700 K	1487.1	13.9 W	80	5.60
	108-2412-70	LED-12/12W / 350 mA - 2700 K	1589.7	13.9 W	70	5.60
	108-2413	LED-12/24W / 700 mA - 2700 K	2637.3	27 W	80	5.60
	108-2413-70	LED-12/24W / 700 mA - 2700 K	2832.7	27 W	70	5.60
	108-2414	LED-24/24W / 350 mA - 2700 K	2974.2	26.5 W	80	5.80
	108-2414-70	LED-24/24W / 350 mA - 2700 K	3179.4	26.5 W	70	5.80
108-2415	LED-24/48W / 700 mA - 2700 K	5274.6	54 W	80	5.80	
108-2415-70	LED-24/48W / 700 mA - 2700 K	5665.3	54 W	70	5.80	
108-2416	LED-24/72W / 1050 mA - 2700 K	8494.7	81 W	80	5.60	
108-2416-70	LED-24/72W / 1050 mA - 2700 K	9737.8	81 W	70	5.60	
asymmetric, side throw [S70] 	108-1289	LED-24/48W / 700 mA - 3000 K	6063.4	54 W	80	5.80
	108-1289-70	LED-24/48W / 700 mA - 3000 K	6899.7	54 W	70	5.80
	108-1290	LED-24/48W / 700 mA - 4000 K	6481.5	54 W	80	5.80
	108-1290-70	LED-24/48W / 700 mA - 4000 K	7317.9	54 W	70	5.80
	108-1299	LED-12/24W / 700 mA - 3000 K	3031.7	27 W	80	5.60

Pole mounted

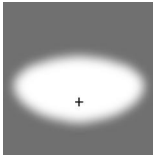
Light distribution	Part ID	Light source	Rated lumens	Rated input power	CRI	Weight (kg)
	108-1299-70	LED-12/24W / 700 mA - 3000 K	3449.9	27 W	70	5.60
	108-1300	LED-12/24W / 700 mA - 4000 K	3240.8	27 W	80	5.60
	108-1300-70	LED-12/24W / 700 mA - 4000 K	3658.9	27 W	70	5.60
	108-1309	LED-24/24W / 350 mA - 3000 K	3402.8	26.5 W	80	5.80
	108-1309-70	LED-24/24W / 350 mA - 3000 K	3951.6	26.5 W	70	5.80
	108-1310	LED-24/24W / 350 mA - 4000 K	3732.1	26.5 W	80	5.80
	108-1310-70	LED-24/24W / 350 mA - 4000 K	4171.1	26.5 W	70	5.80
	108-1319	LED-12/12W / 350 mA - 3000 K	1701.4	13.9 W	80	5.60
	108-1319-70	LED-12/12W / 350 mA - 3000 K	1975.8	13.9 W	70	5.60
	108-1320	LED-12/12W / 350 mA - 4000 K	1866	13.9 W	80	5.60
	108-1320-70	LED-12/12W / 350 mA - 4000 K	2085.6	13.9 W	70	5.60
	108-2062	LED-24/72W / 1050 mA - 3000 K	9707.9	81 W	80	5.60
	108-2062-70	LED-24/72W / 1050 mA - 3000 K	11062.5	81 W	70	5.60
	108-2063	LED-24/72W / 1050 mA - 4000 K	10159.4	81 W	80	5.60
	108-2063-70	LED-24/72W / 1050 mA - 4000 K	11514	81 W	70	5.60
	108-2402	LED-12/12W / 350 mA - 2700 K	1591.6	13.9 W	80	5.60
	108-2402-70	LED-12/12W / 350 mA - 2700 K	1701.4	13.9 W	70	5.60
	108-2403	LED-12/24W / 700 mA - 2700 K	2822.6	27 W	80	5.60
	108-2403-70	LED-12/24W / 700 mA - 2700 K	3031.7	27 W	70	5.60
	108-2404	LED-24/24W / 350 mA - 2700 K	3183.2	26.5 W	80	5.80
	108-2404-70	LED-24/24W / 350 mA - 2700 K	3402.8	26.5 W	70	5.80
	108-2405	LED-24/48W / 700 mA - 2700 K	5645.2	54 W	80	5.80
	108-2405-70	LED-24/48W / 700 mA - 2700 K	6063.4	54 W	70	5.80
	108-2406	LED-24/72W / 1050 mA - 2700 K	9256.3	81 W	80	5.60
	108-2406-70	LED-24/72W / 1050 mA - 2700 K	10610.9	81 W	70	5.60
asymmetric, side throw beam [S60]	108-1287	LED-24/48W / 700 mA - 3000 K	6188.6	54 W	80	5.80
	108-1287-70	LED-24/48W / 700 mA - 3000 K	7042.2	54 W	70	5.80
	108-1288	LED-24/48W / 700 mA - 4000 K	6615.4	54 W	80	5.80
	108-1288-70	LED-24/48W / 700 mA - 4000 K	7469	54 W	70	5.80
	108-1297	LED-12/24W / 700 mA - 3000 K	3094.3	27 W	80	5.60
	108-1297-70	LED-12/24W / 700 mA - 3000 K	3521.1	27 W	70	5.60
	108-1298	LED-12/24W / 700 mA - 4000 K	3307.7	27 W	80	5.60
	108-1298-70	LED-12/24W / 700 mA - 4000 K	3734.5	27 W	70	5.60
	108-1307	LED-24/24W / 350 mA - 3000 K	3428	26.5 W	80	5.80
	108-1307-70	LED-24/24W / 350 mA - 3000 K	3980.9	26.5 W	70	5.80
	108-1308	LED-24/24W / 350 mA - 4000 K	3759.8	26.5 W	80	5.80

Pole mounted

Light distribution	Part ID	Light source	Rated lumens	Rated input power	CRI	Weight (kg)
	108-1308-70	LED-24/24W / 350 mA - 4000 K	4202.1	26.5 W	70	5.80
	108-1317	LED-12/12W / 350 mA - 3000 K	1714	13.9 W	80	5.60
	108-1317-70	LED-12/12W / 350 mA - 3000 K	1990.5	13.9 W	70	5.60
	108-1318	LED-12/12W / 350 mA - 4000 K	1879.9	13.9 W	80	5.60
	108-1318-70	LED-12/12W / 350 mA - 4000 K	2101	13.9 W	70	5.60
	108-2058	LED-24/72W / 1050 mA - 3000 K	9695.3	81 W	80	5.60
	108-2058-70	LED-24/72W / 1050 mA - 3000 K	11048.1	81 W	70	5.60
	108-2059	LED-24/72W / 1050 mA - 4000 K	10146.2	81 W	80	5.60
	108-2059-70	LED-24/72W / 1050 mA - 4000 K	11499.1	81 W	70	5.60
	108-2392	LED-12/12W / 350 mA - 2700 K	1603.4	13.9 W	80	5.60
	108-2392-70	LED-12/12W / 350 mA - 2700 K	1714	13.9 W	70	5.60
	108-2393	LED-12/24W / 700 mA - 2700 K	2880.9	27 W	80	5.60
	108-2393-70	LED-12/24W / 700 mA - 2700 K	3094.3	27 W	70	5.60
	108-2394	LED-24/24W / 350 mA - 2700 K	3206.8	26.5 W	80	5.80
	108-2394-70	LED-24/24W / 350 mA - 2700 K	3428	26.5 W	70	5.80
	108-2395	LED-24/48W / 700 mA - 2700 K	5761.8	54 W	80	5.80
	108-2395-70	LED-24/48W / 700 mA - 2700 K	6188.6	54 W	70	5.80
	108-2396	LED-24/72W / 1050 mA - 2700 K	9244.4	81 W	80	5.60
	108-2396-70	LED-24/72W / 1050 mA - 2700 K	10597.2	81 W	70	5.60
asymmetric, side throw beam [S65]	108-1293	LED-24/48W / 700 mA - 3000 K	6257.8	54 W	80	5.80
	108-1293-70	LED-24/48W / 700 mA - 3000 K	7121	54 W	70	5.80
	108-1294	LED-24/48W / 700 mA - 4000 K	6689.4	54 W	80	5.80
	108-1294-70	LED-24/48W / 700 mA - 4000 K	7552.5	54 W	70	5.80
	108-1303	LED-12/24W / 700 mA - 3000 K	3128.9	27 W	80	5.60
	108-1303-70	LED-12/24W / 700 mA - 3000 K	3560.5	27 W	70	5.60
	108-1304	LED-12/24W / 700 mA - 4000 K	3344.7	27 W	80	5.60
	108-1304-70	LED-12/24W / 700 mA - 4000 K	3776.3	27 W	70	5.60
	108-1313	LED-24/24W / 350 mA - 3000 K	3450.5	26.5 W	80	5.80
	108-1313-70	LED-24/24W / 350 mA - 3000 K	4007	26.5 W	70	5.80
	108-1314	LED-24/24W / 350 mA - 4000 K	3784.4	26.5 W	80	5.80
	108-1314-70	LED-24/24W / 350 mA - 4000 K	4229.6	26.5 W	70	5.80
	108-1323	LED-12/12W / 350 mA - 3000 K	1725.2	13.9 W	80	5.60
	108-1323-70	LED-12/12W / 350 mA - 3000 K	2003.5	13.9 W	70	5.60
	108-1324	LED-12/12W / 350 mA - 4000 K	1892.2	13.9 W	80	5.60
	108-1324-70	LED-12/12W / 350 mA - 4000 K	2114.8	13.9 W	70	5.60
	108-2060	LED-24/72W / 1050 mA - 3000 K	9805	81 W	80	5.60

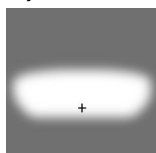

Pole mounted

Light distribution	Part ID	Light source	Rated lumens	Rated input power	CRI	Weight (kg)
	108-2060-70	LED-24/72W / 1050 mA - 3000 K	11173.2	81 W	70	5.60
	108-2061	LED-24/72W / 1050 mA - 4000 K	10261.1	81 W	80	5.60
	108-2061-70	LED-24/72W / 1050 mA - 4000 K	11629.2	81 W	70	5.60
	108-2397	LED-12/12W / 350 mA - 2700 K	1613.9	13.9 W	80	5.60
	108-2397-70	LED-12/12W / 350 mA - 2700 K	1725.2	13.9 W	70	5.60
	108-2398	LED-12/24W / 700 mA - 2700 K	2913.1	27 W	80	5.60
	108-2398-70	LED-12/24W / 700 mA - 2700 K	3128.9	27 W	70	5.60
	108-2399	LED-24/24W / 350 mA - 2700 K	3227.9	26.5 W	80	5.80
	108-2399-70	LED-24/24W / 350 mA - 2700 K	3450.5	26.5 W	70	5.80
	108-2400	LED-24/48W / 700 mA - 2700 K	5826.2	54 W	80	5.80
	108-2400-70	LED-24/48W / 700 mA - 2700 K	6257.8	54 W	70	5.80
	108-2401	LED-24/72W / 1050 mA - 2700 K	9349	81 W	80	5.60
	108-2401-70	LED-24/72W / 1050 mA - 2700 K	10717.1	81 W	70	5.60
pedestrian/bicycle lane [P65]	108-1877	LED-24/48W / 700 mA - 3000 K	6244.8	54 W	80	5.80
	108-1877-70	LED-24/48W / 700 mA - 3000 K	7106.1	54 W	70	5.80
	108-1878	LED-24/48W / 700 mA - 4000 K	6675.5	54 W	80	5.80
	108-1878-70	LED-24/48W / 700 mA - 4000 K	7536.8	54 W	70	5.80
	108-1879	LED-12/24W / 700 mA - 3000 K	3122.4	27 W	80	5.60
	108-1879-70	LED-12/24W / 700 mA - 3000 K	3553.1	27 W	70	5.60
	108-1880	LED-12/24W / 700 mA - 4000 K	3337.7	27 W	80	5.60
	108-1880-70	LED-12/24W / 700 mA - 4000 K	3768.4	27 W	70	5.60
	108-1881	LED-24/24W / 350 mA - 3000 K	3416.6	26.5 W	80	5.80
	108-1881-70	LED-24/24W / 350 mA - 3000 K	3967.7	26.5 W	70	5.80
	108-1882	LED-24/24W / 350 mA - 4000 K	3747.2	26.5 W	80	5.80
	108-1882-70	LED-24/24W / 350 mA - 4000 K	4188.1	26.5 W	70	5.80
	108-1883	LED-12/12W / 350 mA - 3000 K	1708.3	13.9 W	80	5.60
	108-1883-70	LED-12/12W / 350 mA - 3000 K	1983.8	13.9 W	70	5.60
	108-1884	LED-12/12W / 350 mA - 4000 K	1873.6	13.9 W	80	5.60
	108-1884-70	LED-12/12W / 350 mA - 4000 K	2094.1	13.9 W	70	5.60
	108-2054	LED-24/72W / 1050 mA - 3000 K	9608.3	81 W	80	5.60
	108-2054-70	LED-24/72W / 1050 mA - 3000 K	10949	81 W	70	5.60
	108-2055-70	LED-24/72W / 1050 mA - 4000 K	11395.9	81 W	70	5.60
	108-2417	LED-12/12W / 350 mA - 2700 K	1598.1	13.9 W	80	5.60
	108-2417-70	LED-12/12W / 350 mA - 2700 K	1708.3	13.9 W	70	5.60
	108-2418	LED-12/24W / 700 mA - 2700 K	2907.1	27 W	80	5.60
	108-2418-70	LED-12/24W / 700 mA - 2700 K	3122.4	27 W	70	5.60

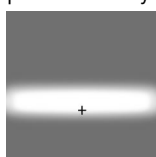

Pole mounted

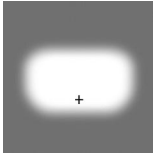
Light distribution	Part ID	Light source	Rated lumens	Rated input power	CRI	Weight (kg)
rectangular, side throw [R65] 	108-2419	LED-24/24W / 350 mA - 2700 K	3196.2	26.5 W	80	5.80
	108-2419-70	LED-24/24W / 350 mA - 2700 K	3416.6	26.5 W	70	5.80
	108-2420	LED-24/48W / 700 mA - 2700 K	5814.1	54 W	80	5.80
	108-2420-70	LED-24/48W / 700 mA - 2700 K	6244.8	54 W	70	5.80
	108-2421-70	LED-24/72W / 1050 mA - 2700 K	10502.1	81 W	70	5.60
	108-1295	LED-24/48W / 700 mA - 3000 K	5788.7	54 W	80	5.80
	108-1295-70	LED-24/48W / 700 mA - 3000 K	6587.2	54 W	70	5.80
	108-1296	LED-24/48W / 700 mA - 4000 K	6187.9	54 W	80	5.80
	108-1296-70	LED-24/48W / 700 mA - 4000 K	6986.4	54 W	70	5.80
	108-1305	LED-12/24W / 700 mA - 3000 K	2894.4	27 W	80	5.60
	108-1305-70	LED-12/24W / 700 mA - 3000 K	3293.6	27 W	70	5.60
	108-1306	LED-12/24W / 700 mA - 4000 K	3094	27 W	80	5.60
	108-1306-70	LED-12/24W / 700 mA - 4000 K	3493.2	27 W	70	5.60
	108-1315	LED-24/24W / 350 mA - 3000 K	3248.6	26.5 W	80	5.80
	108-1315-70	LED-24/24W / 350 mA - 3000 K	3772.6	26.5 W	70	5.80
	108-1316	LED-24/24W / 350 mA - 4000 K	3563	26.5 W	80	5.80
	108-1316-70	LED-24/24W / 350 mA - 4000 K	3982.2	26.5 W	70	5.80
	108-1325	LED-12/12W / 350 mA - 3000 K	1624.3	13.9 W	80	5.60
	108-1325-70	LED-12/12W / 350 mA - 3000 K	1886.3	13.9 W	70	5.60
	108-1326	LED-12/12W / 350 mA - 4000 K	1781.5	13.9 W	80	5.60
	108-1326-70	LED-12/12W / 350 mA - 4000 K	1991.1	13.9 W	70	5.60
	108-2056	LED-24/72W / 1050 mA - 3000 K	9380	81 W	80	5.60
	108-2056-70	LED-24/72W / 1050 mA - 3000 K	10688.8	81 W	70	5.60
	108-2057	LED-24/72W / 1050 mA - 4000 K	9816.3	81 W	80	5.60
	108-2057-70	LED-24/72W / 1050 mA - 4000 K	11125.1	81 W	70	5.60
	108-2407	LED-12/12W / 350 mA - 2700 K	1519.5	13.9 W	80	5.60
	108-2407-70	LED-12/12W / 350 mA - 2700 K	1624.3	13.9 W	70	5.60
	108-2408	LED-12/24W / 700 mA - 2700 K	2694.7	27 W	80	5.60
	108-2408-70	LED-12/24W / 700 mA - 2700 K	2894.4	27 W	70	5.60
	108-2409	LED-24/24W / 350 mA - 2700 K	3039	26.5 W	80	5.80
	108-2409-70	LED-24/24W / 350 mA - 2700 K	3248.6	26.5 W	70	5.80
	108-2410	LED-24/48W / 700 mA - 2700 K	5389.5	54 W	80	5.80
	108-2410-70	LED-24/48W / 700 mA - 2700 K	5788.7	54 W	70	5.80
108-2411	LED-24/72W / 1050 mA - 2700 K	8943.7	81 W	80	5.60	
108-2411-70	LED-24/72W / 1050 mA - 2700 K	10252.6	81 W	70	5.60	

Pole mounted

Control

Eco Step Dim® Basic

Description	Part ID
Eco Step Dim® Basic LED	430-0001

Eco Step Dim® Advanced

Description	Part ID
Eco Step Dim® Advanced LED	430-0002

Eco Step Dim® Motion

Description	Part ID
Eco Step Dim® Motion - Linked	430-0021

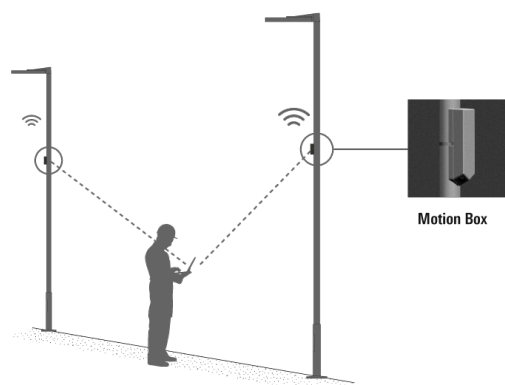

Pole mounted

Description	Part ID
Eco Step Dim® Motion - Connected	430-0022

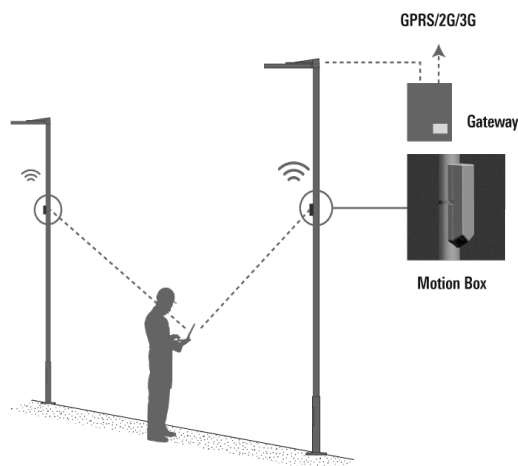

R2C Ready to Connect

Description	Part ID
R2C Ready to Connect (top)	430-0019

Wild-Light Eco Step Dim® Advanced

Description	Part ID	Additional information
Wild-Light Eco Step Dim® Advanced	430-0034	<p>Fully automatic independent dimming pre-set, without additional installation effort, Example: Starting the night with warm white (3000 K from 20:00 to 22:00), reduced to biodiversity friendly in the heart of the night (2200 K from 22:00 to 06:00), and returning back to warm white in the early morning (3000 K from 06:00 to 07:00).</p> <p>This is the easiest to implement solution to create a nature-friendly lighting scenario, as no additional installations or external controls are needed. All pre-settings are made in the two LED drivers. The dimming values are programmed into the driver during the production of the luminaires. An optional link with sunrise and sunset times can mean additional optimisation. A customer-specific configuration is possible.</p> <p>The settings can be changed directly on the LED driver at any time (NFC). The necessary tool is standardised and can also be obtained from WE-EF as an optional extra.</p>
Wild-Light Motion	430-0035	

Pole mounted**Citygrid Motion On Pole**

Description	Part ID	Additional information
Citygrid Motion - Entry-Package	420-0011	Citygrid Motion. Das All-in-One Gerät, das vorhandene Leuchten in ein intelligentes Lichtsystem verwandeln kann.

Einstiegs-Paket

WE-EF liefert und konfiguriert Leuchten und Citygrid System einmalig ab Werk bzw. am Einsatzort. Neukonfiguration als Service abrufbar (kostenpflichtig). Gateway/App nicht inbegriffen.

Anwendungen: Kommunale Einzelprojekte, Insellösungen und Feldversuche für Smart Lighting, z.B. einzelne Straßen, Wege oder Plätze. Halböffentliche oder private Projekte, z.B. Firmengelände, Parkplatz.



Pole mounted

Description	Part ID	Additional information
Citygrid Motion - Standalone-Package	420-0012	<p>Citygrid Motion On Pole Controller.</p> <p>The Citygrid Motion On Pole Controller is the all-in-one device that can convert existing luminaires into an intelligent lighting system.</p> <p>The standalone package: Dongle & apps included; operators can configure, change and service the Citygrid system themselves (on site) using the apps on their mobile device.</p> <p>Applications: demarcated communal projects (street, square, district) or private projects (larger company sites, commercial estates) if qualified personnel are available for the operation of the system.</p>



Pole mounted

Citygrid Motion On Luminaire

Description	Part ID	Additional information
Citygrid Motion - Entry-Package	420-0021	<p>Citygrid On Luminaire - Entry Package Citygrid On Luminaire. Die Sensoren erkennen Bewegung und Verkehr beim Betreten des Sensor und Leuchtenfelds.</p> <p>Einstiegs-Paket WE-EF liefert und konfiguriert Leuchten und Citygrid System einmalig ab Werk bzw. am Einsatzort. Neukonfiguration als Service abrufbar (kostenpflichtig). Gateway/App nicht inbegriffen.</p> <p>Anwendungen: Kommunale Einzelprojekte, Insellösungen und Feldversuche für Smart Lighting, z.B. einzelne Straßen, Wege oder Plätze. Halböffentliche oder private Projekte, z.B. Firmengelände, Parkplatz. Citygrid built-in light controller with angled sensors The sensors detect motion and traffic on entering the sensor and lighting field.</p> <p>The entry-level package: WE-EF supplies and configures luminaires and the Citygrid system once ex works or on site. Reconfiguration is available as a service (chargeable). Gateway/app not included.</p> <p>Applications: individual communal projects, isolated solutions and field trials for smart lighting, e.g. single streets, paths or squares. Semi-public or private projects, e.g. company site, car park.</p>

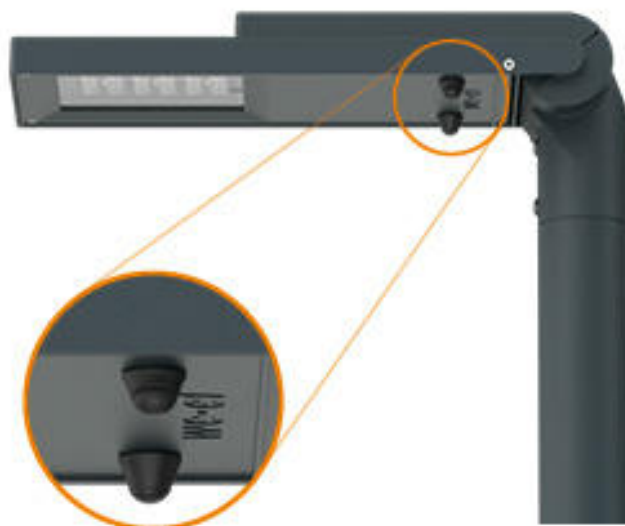

Pole mounted

Description	Part ID	Additional information
Citygrid Motion - Standalone-Package	420-0022	<p>Citygrid Motion built-in light controller with angled sensors The sensors detect motion and traffic on entering the sensor and lighting field.</p> <p>The standalone package: Dongle & apps included; operators can configure, change and service the Citygrid system themselves (on site) using the apps on their mobile device. Applications: demarcated communal projects (street, square, district) or private projects (larger company sites, commercial estates) if qualified personnel are available for the operation of the system.</p>



Pole mounted

Description	Part ID	Additional information
Citygrid Motion - Smart-City-Package	420-0023	<p>Citygrid Motion built-in light controller with angled sensors The sensors detect motion and traffic on entering the sensor and lighting field.</p> <p>The Smart-City package: Internet gateway (via mobile phone) and dashboard included; operators can configure, change and service themselves (remotely). Networked Smart-City functions (data collection, remote maintenance, etc.). Applications: larger communal projects or field trials in the context of Smart City; operator has qualified personnel (municipal utilities).</p>



Citygrid Motion Zhaga

Description	Part ID	Additional information
Citygrid Motion - Standalone-Package	420-0032	Citygrid Motion Zhaga controller with sensor. The compact all-in-one design turns every luminaire with a Zhaga Book 18 socket facing the street surface into motion-controlled, intelligent street & area lighting.

The standalone package:

Dongle & apps included; operators can configure, change and service the Citygrid system themselves (on site) using the apps on their mobile device.

Applications: demarcated communal projects (street, square, district) or private projects (larger company sites, commercial estates) if qualified personnel are available for the operation of the system.



Pole mounted

Description	Part ID	Additional information
Citygrid Motion - Smart-City-Package	420-0033	<p>Citygrid Motion Zhaga controller with sensor.</p> <p>The compact all-in-one design turns every luminaire with a Zhaga Book 18 socket facing the street surface into motion-controlled, intelligent street & area lighting.</p> <p>The Smart-City package: Internet gateway (via mobile phone) and dashboard included; operators can configure, change and service themselves (remotely). Networked Smart-City functions (data collection, remote maintenance, etc.).</p> <p>Applications: larger communal projects or field trials in the context of Smart City; operator has qualified personnel (municipal utilities).</p>



Pole mounted

Wild-Light Citygrid Motion On Pole

Description	Part ID	Additional information
Wild-Light Citygrid Motion - Entry- Package	420-1111	Citygrid Motion On Pole Controller. The Citygrid Motion On Pole Controller is the all-in-one device that can convert existing luminaires into an intelligent lighting system.

The entry-level package:
WE-EF supplies and configures luminaires and the Citygrid system once ex works or on site. Reconfiguration is available as a service (chargeable). Gateway/app not included.

Applications: individual communal projects, isolated solutions and field trials for smart lighting, e.g. single streets, paths or squares. Semi-public or private projects, e.g. company site, car park.



Pole mounted

Description	Part ID	Additional information
Wild-Light Citygrid Motion - Standalone-Package	420-1112	<p>Citygrid Motion On Pole Controller for Wild-Light.</p> <p>The Citygrid Motion On Pole Controller is the all-in-one device that can convert existing luminaires into an intelligent lighting system.</p> <p>The standalone package: Dongle & apps included; operators can configure, change and service the Citygrid system themselves (on site) using the apps on their mobile device.</p> <p>Applications: demarcated communal projects (street, square, district) or private projects (larger company sites, commercial estates) if qualified personnel are available for the operation of the system.</p>



Pole mounted

Description	Part ID	Additional information
Wild-Light Citygrid Motion - Smart-City-Package	420-1113	<p>Citygrid Motion On Pole Controller for Wild-Light.</p> <p>The Citygrid Motion On Pole Controller is the all-in-one device that can convert existing luminaires into an intelligent lighting system.</p> <p>The Smart-City package: Internet gateway (via mobile phone) and dashboard included; operators can configure, change and service themselves (remotely). Networked Smart-City functions (data collection, remote maintenance, etc.).</p> <p>Applications: larger communal projects or field trials in the context of Smart City; operator has qualified personnel (municipal utilities).</p>



Mounting Accessories

Pole brackets RF

Description	Part ID	C1	D × L1	H1	Weight (kg)	C	H
RF1-530 Pole bracket, single	111-0044	190	76 x 80	275	2.30	190	275

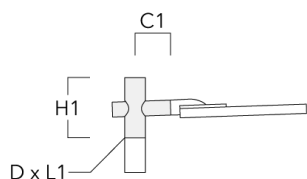

RF2-530 Pole bracket, double	111-0045	190	76 x 80	275	3.00	190	275
------------------------------	----------	-----	---------	-----	------	-----	-----

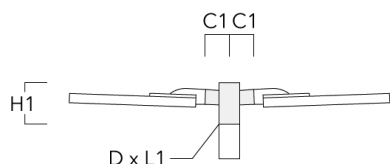

Pole mounted

Wall and pole brackets RE

Description	Part ID	C1	D1	D2	D × L1	H1	M1	Weight (kg)	C	H
RE0-530 Wall bracket	111-0052	180	230	195			12	2.90	120	

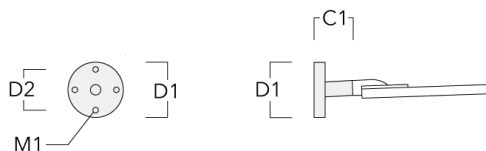

RE1-530 Pole bracket, single	111-0040	180			76 x 80	400		3.20	180	400
------------------------------	----------	-----	--	--	---------	-----	--	------	-----	-----

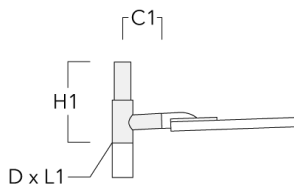

Pole mounted

Description	Part ID	C1	D1	D2	D × L1	H1	M1	Weight (kg)	C	H
RE2-530 Pole bracket, double	111-0041	180			76 x 80	400		3.60	180	400

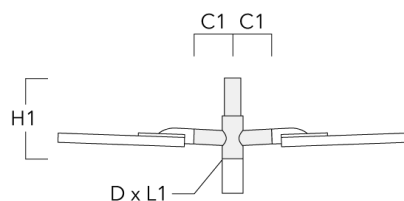

Wall and pole brackets RI

Description	Part ID	C1	D1	H1	Weight (kg)	D	H
RI-530 Wall and pole bracket	111-0178	184-255	76-133	127	1.85	102-133	96

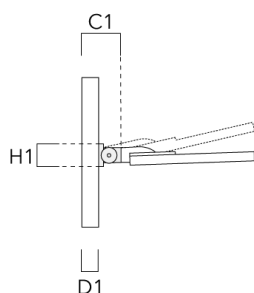

Pole mounted

Wall and pole brackets RX

Description	Part ID	C1	D1	D2	D × L1	H1	H2	M1	M2	Weight (kg)
RX0-530 Wall bracket	111-0053	710	140	100		350	285	30	12	3.30

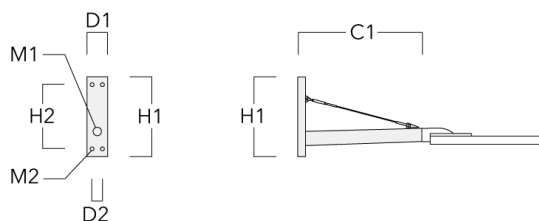

RX1-530 Pole bracket, single	111-0088	710			76 x 80	400				4.50
------------------------------	----------	-----	--	--	---------	-----	--	--	--	------

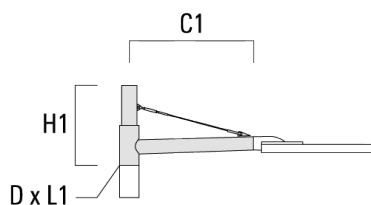

Pole mounted

Description	Part ID	C1	D1	D2	D × L1	H1	H2	M1	M2	Weight (kg)
RX2-530 Pole bracket, double	111-0089	710			76 x 80	400				6.20

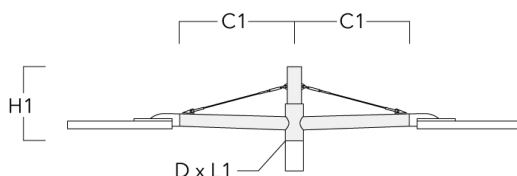

Tilt brackets TB

Description	Part ID	A	D1	D2	L	Weight (kg)
TB-530.42-10 Tilt bracket 10°	111-0639	10°	42 x 90	42 x 100	205	0.50

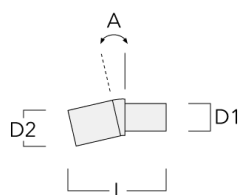

VFL530-SE LED

Pole mounted

Description	Part ID	A	D1	D2	L	Weight (kg)
TB-530.42-15 Tilt bracket 15°	111-0640	15°	42 x 90	42 x 100	205	0.50

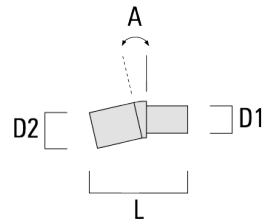

Optical Accessories**Light shield**

Description	Part ID	Additional information
LS180-[A60]	430-0038	Light shield LS180 to greatly reduce or eliminate light pollution. PA injection moulded component, black matt. Suitable for asymmetric light distribution [A60].
LS180	430-0029	Glare Shield for backlight spill. Glare Shield factory-installed or available as retrofit kit. Suitable for [S60], [S65], [S70], [R65], [P65] lenses. Must be specified at time of ordering.