

# VFL530-SE LED

## Street and Area Lighting

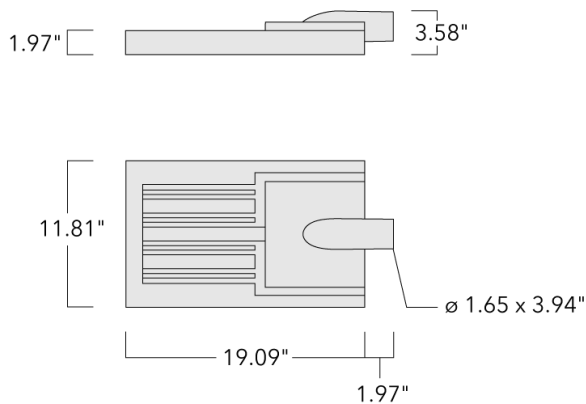

### Description

Pole or wall-mounted LED luminaire with integrated heat sinks. Side-entry mount.

IP66. Class I or Class II. IK08. Marine-grade, die-cast aluminum alloy. 5CE superior corrosion protection including PCS hardware. Silicone CCG® Controlled Compression Gasket. RFC® Reflection Free Contour main lens. CAD-optimized optics for superior illumination and glare control. Integral driver in thermally separated compartment. OLC® One LED Concept. Factory-installed LED circuit board. 0-10V Dimming comes standard with luminaire. Luminaire is factory-sealed and does not need to be opened during installation.

Recommended mounting height 10-30 ft, depending on lamp type selected.

Specify product with 7 Digit product code - Finish Color. Accessories, such as mounting, optical, and electrical, must be specified separately.





Example: XXX-XXXX-9004 (Black)  
+ XXX-XXXX (Accessory 1)

### WE-EF LIGHTING USA, LLC

410-D Keystone Drive, 15086 Warrendale, PA 15086 - Phone: +1 724 742 0030  
customersupport.usa@we-ef.com - <https://we-ef.com/us>  
Subject to technical changes and errors. - Generated on 11/23/2024

**Street and Area Lighting****Specifications****Material description**

---

Body	Marine-grade die-cast aluminium alloy
Lens	PMMA RFC Reflection Contour Lens technology
Colors	 RAL9004 Black  RAL9007 Grey Metallic  RAL9016 White  RAL8019 Dark Bronze
Gasket	Silicone rubber gasket
Fasteners	PCS Polymer Coated Stainless Steel hardware
Ingress protection	IP66
Impact resistance	IK08
Corrosion resistance	5CE
Windage	1.6 ft <sup>2</sup>

---

**Electrical description**

---

Power supply	Integral [ECG] electronic driver 120V-277V. 0-10V dimmable, to be specified with order.
Driver / Ballast	Integral 120-277V EC electronic converter with 0-10V dimming.
Power factor	> 0.9
Surge protection	In-line bracket 10kV Surge Protector

---

**Additional information**

---

Lifetime	Ta=25°/40° L90B10 > 90000h
BUG Rating	Please see individual Spec Sheets for classification of Backlight, Uplight and Glare.
Listings	ETL, UL-1598, CSA-C22.2#250.0. Suitable for Wet Locations.

---

**WE-EF LIGHTING USA, LLC**

410-D Keystone Drive, 15086 Warrendale, PA 15086 - Phone: +1 724 742 0030

customersupport.usa@we-ef.com - <https://we-ef.com/us>

Subject to technical changes and errors. - Generated on 11/23/2024

# VFL530-SE LED

## Street and Area Lighting

### Options

#### Light distribution

#### Color temperature

#### Nominal Watt



[S60] Type III Short



3000 K

58 W

29 W

15 W



[S70] Type II Short



4000 K



[A60] Type IV Very Short



2700 K



[S65] Type III Medium



[R65] Type IV Medium



[P65] Type II Medium

#### WE-EF LIGHTING USA, LLC

410-D Keystone Drive, 15086 Warrendale, PA 15086 - Phone: +1 724 742 0030

customersupport.usa@we-ef.com - <https://we-ef.com/us>

Subject to technical changes and errors. - Generated on 11/23/2024

## Configurations

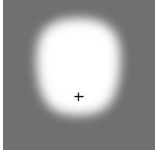
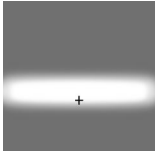
Light distribution	Part ID	Light source	Rated lumens	Rated input power	CRI	Weight (lb)
[A60] Type IV Very Short 	108-1291	LED-24/48W / 700 mA - 3000 K	5665.3	54 W	80	12.80
	108-1292	LED-24/48W / 700 mA - 4000 K	6056	54 W	80	12.80
	108-1301	LED-12/24W / 700 mA - 3000 K	2832.7	27 W	80	12.30
	108-1302	LED-12/24W / 700 mA - 4000 K	3028	27 W	80	12.30
	108-1311	LED-24/24W / 350 mA - 3000 K	3179.4	26.5 W	80	12.80
	108-1312	LED-24/24W / 350 mA - 4000 K	3487	26.5 W	80	12.80
	108-1321	LED-12/12W / 350 mA - 3000 K	1589.7	13.9 W	80	12.30
	108-1322	LED-12/12W / 350 mA - 4000 K	1743.5	13.9 W	80	12.30
	108-2052	LED-24/72W / 1050 mA - 3000 K	8909.1	81 W	80	12.30
	108-2053	LED-24/72W / 1050 mA - 4000 K	9323.5	81 W	80	12.30
	108-2412	LED-12/12W / 350 mA - 2700 K	1487.1	13.9 W	80	12.30
	108-2413	LED-12/24W / 700 mA - 2700 K	2637.3	27 W	80	12.30
	108-2414	LED-24/24W / 350 mA - 2700 K	2974.2	26.5 W	80	12.80
	108-2415	LED-24/48W / 700 mA - 2700 K	5274.6	54 W	80	12.80
	108-2416	LED-24/72W / 1050 mA - 2700 K	8494.7	81 W	80	12.30
[P65] Type II Medium 	108-1877	LED-24/48W / 700 mA - 3000 K	6244.8	54 W	80	12.30
	108-1878	LED-24/48W / 700 mA - 4000 K	6675.5	54 W	80	12.30
	108-1879	LED-12/24W / 700 mA - 3000 K	3122.4	27 W	80	12.30
	108-1880	LED-12/24W / 700 mA - 4000 K	3337.7	27 W	80	12.30
	108-1881	LED-24/24W / 350 mA - 3000 K	3416.6	26.5 W	80	12.80
	108-1882	LED-24/24W / 350 mA - 4000 K	3747.2	26.5 W	80	12.80
	108-1883	LED-12/12W / 350 mA - 3000 K	1708.3	13.9 W	80	12.30
	108-1884	LED-12/12W / 350 mA - 4000 K	1873.6	13.9 W	80	12.30
	108-2054	LED-24/72W / 1050 mA - 3000 K	9608.3	81 W	80	12.30
	108-2055	LED-24/72W / 1050 mA - 4000 K	10055.2	81 W	80	12.30
	108-2417	LED-12/12W / 350 mA - 2700 K	1598.1	13.9 W	80	12.30
	108-2418	LED-12/24W / 700 mA - 2700 K	2907.1	27 W	80	12.30
	108-2419	LED-24/24W / 350 mA - 2700 K	3196.2	26.5 W	80	12.80
	108-2420	LED-24/48W / 700 mA - 2700 K	5814.1	54 W	80	12.30
	108-2421	LED-24/72W / 1050 mA - 2700 K	9161.4	81 W	80	12.30
[R65] Type IV Medium	108-1295	LED-24/48W / 700 mA - 3000 K	5788.7	54 W	80	12.80
	108-1296	LED-24/48W / 700 mA - 4000 K	6187.9	54 W	80	12.80

## WE-EF LIGHTING USA, LLC

410-D Keystone Drive, 15086 Warrendale, PA 15086 - Phone: +1 724 742 0030

customersupport.usa@we-ef.com - <https://we-ef.com/us>

Subject to technical changes and errors. - Generated on 11/23/2024

## Street and Area Lighting

Light distribution	Part ID	Light source	Rated lumens	Rated input power	CRI	Weight (lb)
	108-1305	LED-12/24W / 700 mA - 3000 K	2894.4	27 W	80	12.30
	108-1306	LED-12/24W / 700 mA - 4000 K	3094	27 W	80	12.30
	108-1315	LED-24/24W / 350 mA - 3000 K	3248.6	26.5 W	80	12.80
	108-1316	LED-24/24W / 350 mA - 4000 K	3563	26.5 W	80	12.80
	108-1325	LED-12/12W / 350 mA - 3000 K	1624.3	13.9 W	80	12.30
	108-1326	LED-12/12W / 350 mA - 4000 K	1781.5	13.9 W	80	12.30
	108-2056	LED-24/72W / 1050 mA - 3000 K	9380	81 W	80	12.30
	108-2057	LED-24/72W / 1050 mA - 4000 K	9816.3	81 W	80	12.30
	108-2407	LED-12/12W / 350 mA - 2700 K	1519.5	13.9 W	80	12.30
	108-2408	LED-12/24W / 700 mA - 2700 K	2694.7	27 W	80	12.30
	108-2409	LED-24/24W / 350 mA - 2700 K	3039	26.5 W	80	12.80
	108-2410	LED-24/48W / 700 mA - 2700 K	5389.5	54 W	80	12.80
	108-2411	LED-24/72W / 1050 mA - 2700 K	8943.7	81 W	80	12.30
[S60] Type III Short	108-1287	LED-24/48W / 700 mA - 3000 K	6188.6	54 W	80	12.80
	108-1288	LED-24/48W / 700 mA - 4000 K	6615.4	54 W	80	12.80
	108-1297	LED-12/24W / 700 mA - 3000 K	3094.3	27 W	80	12.30
	108-1298	LED-12/24W / 700 mA - 4000 K	3307.7	27 W	80	12.30
	108-1307	LED-24/24W / 350 mA - 3000 K	3428	26.5 W	80	12.80
	108-1308	LED-24/24W / 350 mA - 4000 K	3759.8	26.5 W	80	12.80
	108-1317	LED-12/12W / 350 mA - 3000 K	1714	13.9 W	80	12.30
	108-1318	LED-12/12W / 350 mA - 4000 K	1879.9	13.9 W	80	12.30
	108-2058	LED-24/72W / 1050 mA - 3000 K	9695.3	81 W	80	12.30
	108-2059	LED-24/72W / 1050 mA - 4000 K	10146.2	81 W	80	12.30
	108-2392	LED-12/12W / 350 mA - 2700 K	1603.4	13.9 W	80	12.30
	108-2393	LED-12/24W / 700 mA - 2700 K	2880.9	27 W	80	12.30
	108-2394	LED-24/24W / 350 mA - 2700 K	3206.8	26.5 W	80	12.80
108-2395	LED-24/48W / 700 mA - 2700 K	5761.8	54 W	80	12.80	
108-2396	LED-24/72W / 1050 mA - 2700 K	9244.4	81 W	80	12.30	
[S65] Type III Medium	108-1293	LED-24/48W / 700 mA - 3000 K	6257.8	54 W	80	12.80
	108-1294	LED-24/48W / 700 mA - 4000 K	6689.4	54 W	80	12.80
	108-1303	LED-12/24W / 700 mA - 3000 K	3128.9	27 W	80	12.30
	108-1304	LED-12/24W / 700 mA - 4000 K	3344.7	27 W	80	12.30
	108-1313	LED-24/24W / 350 mA - 3000 K	3450.5	26.5 W	80	12.80

### WE-EF LIGHTING USA, LLC

410-D Keystone Drive, 15086 Warrendale, PA 15086 - Phone: +1 724 742 0030

customersupport.usa@we-ef.com - <https://we-ef.com/us>

Subject to technical changes and errors. - Generated on 11/23/2024

# VFL530-SE LED

## Street and Area Lighting

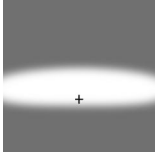
Light distribution	Part ID	Light source	Rated lumens	Rated input power	CRI	Weight (lb)
	108-1314	LED-24/24W / 350 mA - 4000 K	3784.4	26.5 W	80	12.80
	108-1323	LED-12/12W / 350 mA - 3000 K	1725.2	13.9 W	80	12.30
	108-1324	LED-12/12W / 350 mA - 4000 K	1892.2	13.9 W	80	12.30
	108-2060	LED-24/72W / 1050 mA - 3000 K	9805	81 W	80	12.30
	108-2061	LED-24/72W / 1050 mA - 4000 K	10261.1	81 W	80	12.30
	108-2397	LED-12/12W / 350 mA - 2700 K	1613.9	13.9 W	80	12.30
	108-2398	LED-12/24W / 700 mA - 2700 K	2913.1	27 W	80	12.30
	108-2399	LED-24/24W / 350 mA - 2700 K	3227.9	26.5 W	80	12.80
	108-2400	LED-24/48W / 700 mA - 2700 K	5826.2	54 W	80	12.80
	108-2401	LED-24/72W / 1050 mA - 2700 K	9349	81 W	80	12.30
[S70] Type II Short	108-1289	LED-24/48W / 700 mA - 3000 K	6063.4	54 W	80	12.80
	108-1290	LED-24/48W / 700 mA - 4000 K	6481.5	54 W	80	12.80
	108-1299	LED-12/24W / 700 mA - 3000 K	3031.7	27 W	80	12.30
	108-1300	LED-12/24W / 700 mA - 4000 K	3240.8	27 W	80	12.30
	108-1309	LED-24/24W / 350 mA - 3000 K	3402.8	26.5 W	80	12.80
	108-1310	LED-24/24W / 350 mA - 4000 K	3732.1	26.5 W	80	12.80
	108-1319	LED-12/12W / 350 mA - 3000 K	1701.4	13.9 W	80	12.30
	108-1320	LED-12/12W / 350 mA - 4000 K	1866	13.9 W	80	12.30
	108-2062	LED-24/72W / 1050 mA - 3000 K	9707.9	81 W	80	12.30
	108-2063	LED-24/72W / 1050 mA - 4000 K	10159.4	81 W	80	12.30
	108-2402	LED-12/12W / 350 mA - 2700 K	1591.6	13.9 W	80	12.30
	108-2403	LED-12/24W / 700 mA - 2700 K	2822.6	27 W	80	12.30
	108-2405	LED-24/48W / 700 mA - 2700 K	5645.2	54 W	80	12.80
	108-2406	LED-24/72W / 1050 mA - 2700 K	9256.3	81 W	80	12.30

### WE-EF LIGHTING USA, LLC

410-D Keystone Drive, 15086 Warrendale, PA 15086 - Phone: +1 724 742 0030

customersupport.usa@we-ef.com - <https://we-ef.com/us>

Subject to technical changes and errors. - Generated on 11/23/2024

**Mounting Accessories**

**Pole brackets RF**

Description	Part ID	C1	D x L1	H1	L	Weight(lb)	C	H
RF1-530 Pole bracket, single	111-0044	7.48	3 x 3	10.83	2.99	5.07	190	275

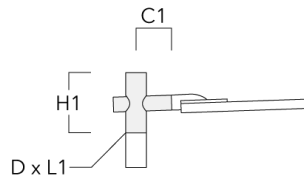

RF2-530 Pole bracket, double	111-0045	7.48	3 x 3	10.83	2.99	6.61	190	275
------------------------------	----------	------	-------	-------	------	------	-----	-----

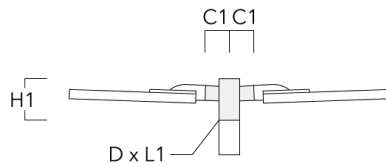

Wall and pole brackets RE

Description	Part ID	C1	D1	D2	D x L1	H1	L	M1	Weight (lb)	C	H
RE0-530 Wall bracket	111-0052	7.09	9.06	7.68				0.47	6.39	120	

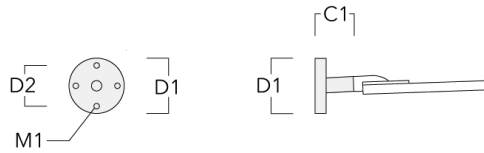

RE1-530 Pole bracket, single	111-0040	7.09			3 x 3	15.75	2.99	7.05		180	400
------------------------------	----------	------	--	--	-------	-------	------	------	--	-----	-----

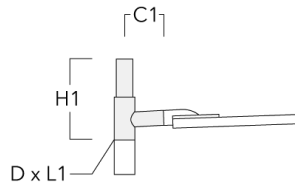



Street and Area Lighting

Description	Part ID	C1	D1	D2	D × L1	H1	L	M1	Weight (lb)	C	H
RE2-530 Pole bracket, double	111-0041	7.09			3 x 3	15.75	2.99		7.94	180	400

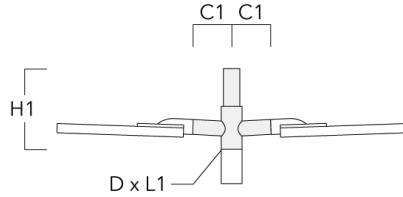

Wall and pole brackets RX

Description	Part ID	C1	D1	D2	D × L1	H1	H2	M1	M2	Weight (lb)
RX0-530 Wall bracket	111-0053	27.95	5.51	3.94		13.78	11.22	1.18	0.47	7.28

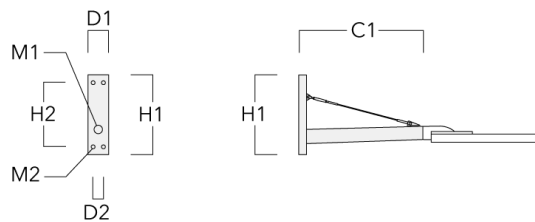

**WE-EF LIGHTING USA, LLC**

410-D Keystone Drive, 15086 Warrendale, PA 15086 - Phone: +1 724 742 0030

customersupport.usa@we-ef.com - <https://we-ef.com/us>

Subject to technical changes and errors. - Generated on 11/23/2024

Street and Area Lighting

Description	Part ID	C1	D1	D2	D x L1	H1	H2	M1	M2	Weight (lb)
RX1-530 Pole bracket, single	111-0088	27.95			3 x 3	15.75				9.92

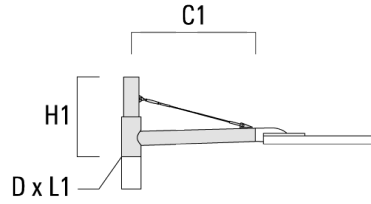

RX2-530 Pole bracket, double	111-0089	27.95			3 x 3	15.75				13.67
------------------------------	----------	-------	--	--	-------	-------	--	--	--	-------

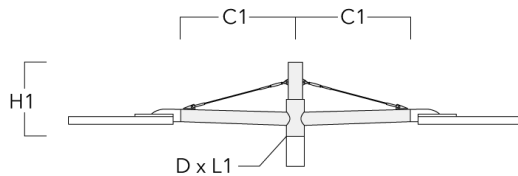

**WE-EF LIGHTING USA, LLC**

410-D Keystone Drive, 15086 Warrendale, PA 15086 - Phone: +1 724 742 0030  
 customersupport.usa@we-ef.com - <https://we-ef.com/us>

Subject to technical changes and errors. - Generated on 11/23/2024

Street and Area Lighting

Wall and pole brackets RI

Description	Part ID	C1	D1	D x L1	H1	L	Weight (lb)
R10-530 Adjustable wall and pole bracket	111-0178	7.24-10"	3-5.25"		5"		4.08 lbs

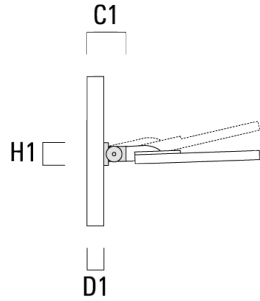

R11-530 Adjustable pole bracket, single	106-0454	7.68"		3 x 3	18.70		10.00 lbs
---	----------	-------	--	-------	-------	--	-----------

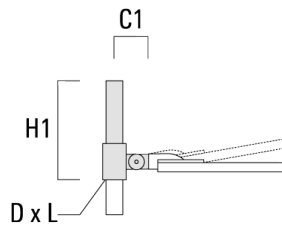

# VFL530-SE LED

## Street and Area Lighting

Description	Part ID	C1	D1	D x L1	H1	L	Weight (lb)
R12-530 Adjustable pole bracket, double	106-0455	7.68"		3 x 3	18.70"	2.99"	13.00 lbs

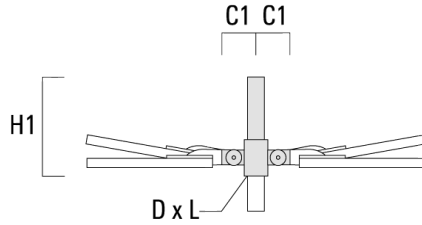

## Tilt brackets TB

Description	Part ID	A	D1	D2	L	Weight (lb)
TB-530.42-10 Tilt bracket 10°	111-0639	10°	1.65 x 3.54	1.65 x 3.94	8.07"	1.10

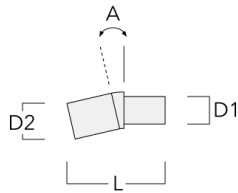

### WE-EF LIGHTING USA, LLC

410-D Keystone Drive, 15086 Warrendale, PA 15086 - Phone: +1 724 742 0030  
customersupport.usa@we-ef.com - <https://we-ef.com/us>

Subject to technical changes and errors. - Generated on 11/23/2024

# VFL530-SE LED

## Street and Area Lighting

Description	Part ID	A	D1	D2	L	Weight (lb)
TB-530.42-15 Tilt bracket 15°	111-0640	15°	1.65 x 3.54	1.65 x 3.94	8.07"	1.10

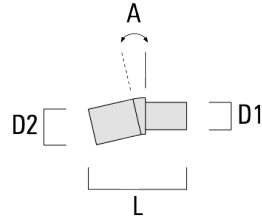

## Pole clamp SI

Description	Part ID	C1	D1	Weight (lb)	C	D
SI1-530 Pole clamp, single (Ø 3"-3.5")	111-0066	7.68"	3.0"-3.5"	7.00 lbs	195	76 - 89

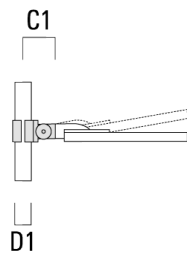

### WE-EF LIGHTING USA, LLC

410-D Keystone Drive, 15086 Warrendale, PA 15086 - Phone: +1 724 742 0030  
customersupport.usa@we-ef.com - <https://we-ef.com/us>

Subject to technical changes and errors. - Generated on 11/23/2024

Street and Area Lighting

Description	Part ID	C1	D1	Weight (lb)	C	D
SI1-530 Pole clamp, single (Ø 4"-4.5")	111-0067	7.68"	4.0"-4.5"	8.00 lbs	195	102 - 114

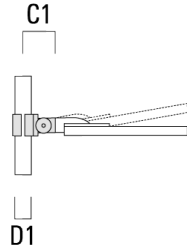

SI1-530 Pole clamp, single (Ø 4.5"-5.25")	111-0176	7.68"	4.50"-5.25"	9.00 lbs	195	114 - 133
---	----------	-------	-------------	----------	-----	-----------

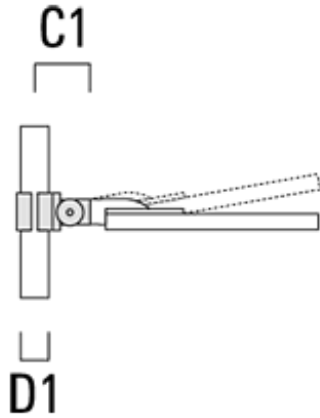

**WE-EF LIGHTING USA, LLC**

410-D Keystone Drive, 15086 Warrendale, PA 15086 - Phone: +1 724 742 0030  
 customersupport.usa@we-ef.com - <https://we-ef.com/us>

Subject to technical changes and errors. - Generated on 11/23/2024

**Street and Area Lighting**

Description	Part ID	C1	D1	Weight (lb)	C	D
SI2-530 Pole clamp, double (Ø 3"-3.5")	111-0068	7.68"	3.0"-3.5"	9.00 lbs	195	76 - 89

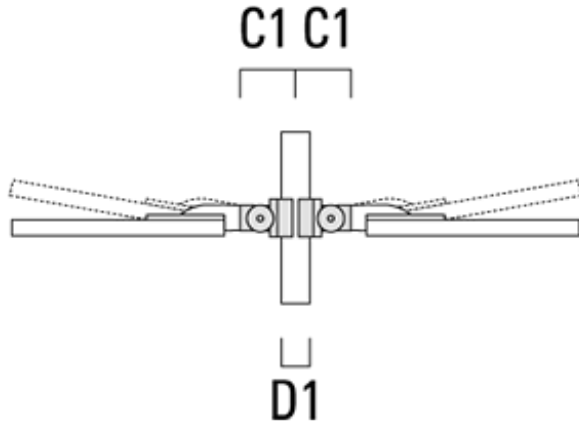

SI2-530 Pole clamp, double (Ø 4"-4.5")	111-0069	7.68"	4.0"-4.5"	11.00 lbs	195	102 - 114
--	----------	-------	-----------	-----------	-----	-----------

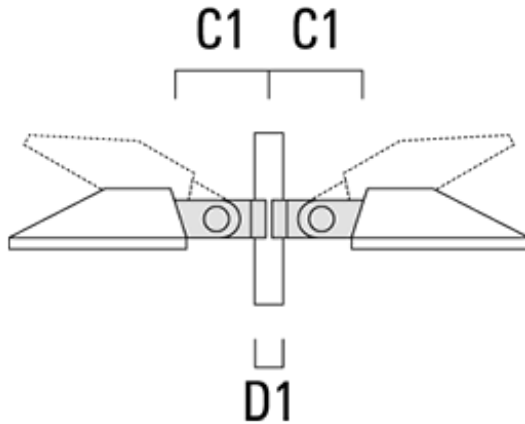

**WE-EF LIGHTING USA, LLC**

410-D Keystone Drive, 15086 Warrendale, PA 15086 - Phone: +1 724 742 0030  
 customersupport.usa@we-ef.com - <https://we-ef.com/us>  
 Subject to technical changes and errors. - Generated on 11/23/2024

**Street and Area Lighting**

Description	Part ID	C1	D1	Weight (lb)	C	D
SI2-530 Pole clamp, double (Ø 4.5"-5.25")	111-0182	7.68"	4.50"-5.25"	12.00	195	114 - 133

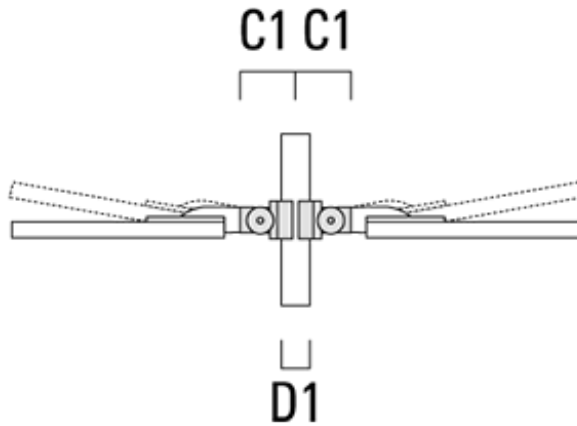

**WE-EF LIGHTING USA, LLC**

410-D Keystone Drive, 15086 Warrendale, PA 15086 - Phone: +1 724 742 0030  
customersupport.usa@we-ef.com - <https://we-ef.com/us>  
Subject to technical changes and errors. - Generated on 11/23/2024



**Street and Area Lighting****Optical Accessories****Light shield**

Description	Part ID	Additional information
LS180-[A60]	430-0038	Light shield LS180 to greatly reduce or eliminate light pollution. PA injection moulded component, black matt. Suitable for asymmetric light distribution [A60].
LS180	430-0029	Glare Shield for backlight spill. Glare Shield factory-installed or available as retrofit kit. Suitable for [S60], [S65], [S70], [R65], [P65] lenses. Must be specified at time of ordering.