

ASP534 LED

Pole mounted

we-ef

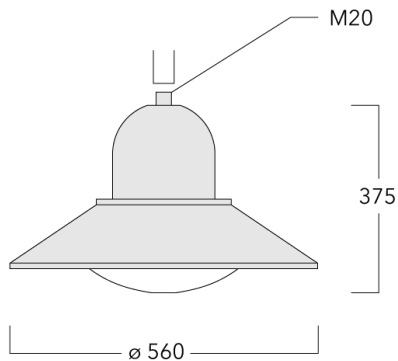

Description

IP55, Class I. Class II on request. IK10. Marine-grade, die-cast aluminium alloy. 5CE superior corrosion protection including PCS hardware. Silicone rubber gasket. Polycarbonate main lens. Integral EC electronic converter in thermally separated compartment. CAD-optimised optics for superior illumination and glare control. OLC® One LED Concept. Factory installed LED circuit board. The luminaire is factory-sealed and does not need to be opened during installation.

Optional 2200 K version available. To be specified at time of ordering.





Brackets to be ordered separately.

WE-EF LEUCHTEN GmbH

Töpinger Straße 16, 29646 Bispingen, Germany - Phone: +49 5194 909-0
info@we-ef.com - <https://we-ef.com>

Subject to technical changes and errors. - Generated on 23/10/2024

Specifications**Material description**

Body	Marine-grade, die-cast aluminium alloy
Lens	Polycarbonate lens
Colours	 RAL9004 Signal black  RAL9006 White aluminium  RAL9007 Grey aluminium  RAL7016 Anthracite grey  RAL9016 Traffic white
Gasket	Silicone rubber gasket
Fasteners	PCS Polymer Coated Stainless Steel Hardware
Ingress protection	IP55
Impact resistance	IK10
Corrosion resistance	5CE
Windage	0.0898 m ²

Electrical description

Power supply	220-240V / 50-60 Hz
Driver / Ballast	Integral EC electronic converter. DALI
Power factor	> 0.9
Surge protection	6/6 kV (optional SP10)

Additional information

Lifetime	Ta=25° L90B10 > 90000h
Energy efficiency class	C-D (Light source)

ASP534 LED

Pole mounted

Options

Light distribution



asymmetric, side throw beam [S65]



rectangular, side throw [R65]

Colour temperature



3000 K



4000 K



2700 K

Nominal Watt

58 W

29 W

Configurations

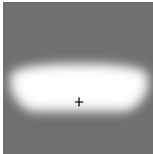
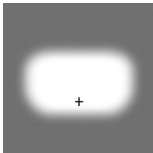
Light distribution	Part ID	Light source	Rated lumens	Rated input power	CRI	Weight (kg)	
asymmetric, side throw beam [S65] 	127-1230	LED-24/48W / 700 mA - 3000 K	5920.9	54 W	80	11.40	
	127-1230-70	LED-24/48W / 700 mA - 3000 K	6737.6	54 W	70	11.40	
	127-1231	LED-24/48W / 700 mA - 4000 K	6329.3	54 W	80	11.40	
	127-1231-70	LED-24/48W / 700 mA - 4000 K	7146	54 W	70	11.40	
	127-1234	LED-12/24W / 700 mA - 3000 K	2960.5	27 W	80	11.40	
	127-1234-70	LED-12/24W / 700 mA - 3000 K	3368.8	27 W	70	11.40	
	127-1235	LED-12/24W / 700 mA - 4000 K	3164.6	27 W	80	11.40	
	127-1235-70	LED-12/24W / 700 mA - 4000 K	3573	27 W	70	11.40	
	127-1421	LED-12/24W / 700 mA - 2700 K	2756.3	27 W	80	11.40	
	127-1421-70	LED-12/24W / 700 mA - 2700 K	2960.5	27 W	70	11.40	
	127-1422	LED-24/48W / 700 mA - 2700 K	5512.6	54 W	80	11.40	
	127-1422-70	LED-24/48W / 700 mA - 2700 K	5920.9	54 W	70	11.40	
	rectangular, side throw [R65] 	127-1232	LED-24/48W / 700 mA - 3000 K	5398.9	54 W	80	11.40
		127-1232-70	LED-24/48W / 700 mA - 3000 K	6143.5	54 W	70	11.40
127-1233		LED-24/48W / 700 mA - 4000 K	5771.2	54 W	80	11.40	
127-1233-70		LED-24/48W / 700 mA - 4000 K	6515.9	54 W	70	11.40	
127-1236		LED-12/24W / 700 mA - 3000 K	2699.4	27 W	80	11.40	
127-1236-70		LED-12/24W / 700 mA - 3000 K	3071.8	27 W	70	11.40	
127-1237		LED-12/24W / 700 mA - 4000 K	2885.6	27 W	80	11.40	
127-1237-70		LED-12/24W / 700 mA - 4000 K	3257.9	27 W	70	11.40	
127-1423		LED-12/24W / 700 mA - 2700 K	2513.3	27 W	80	11.40	
127-1423-70		LED-12/24W / 700 mA - 2700 K	2699.4	27 W	70	11.40	
127-1424		LED-24/48W / 700 mA - 2700 K	5026.5	54 W	80	11.40	
127-1424-70		LED-24/48W / 700 mA - 2700 K	5398.9	54 W	70	11.40	

ASP534 LED

Pole mounted

we-ef

Control

Eco Step Dim® Basic

Description	Part ID
Eco Step Dim® Basic LED	430-0001

Eco Step Dim® Advanced

Description	Part ID
Eco Step Dim® Advanced LED	430-0002

WE-EF LEUCHTEN GmbH

Töpinger Straße 16, 29646 Bispingen, Germany - Phone: +49 5194 909-0

info@we-ef.com - <https://we-ef.com>

Subject to technical changes and errors. - Generated on 23/10/2024

Mounting Accessories

Wall and pole brackets BA

Description	Part ID	C1	D x L1	H1	H2	M1	Weight (kg)	C	H
BA0-420 Wall bracket, single	300-0152	460		1000	132	9	2	460	1000

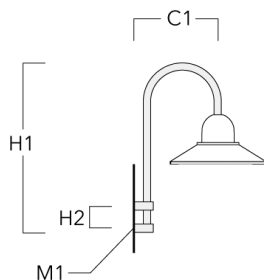

BA1-420 Pole bracket, single	300-0099	420	76 x 80	1000			4	420	1000
------------------------------	----------	-----	---------	------	--	--	---	-----	------

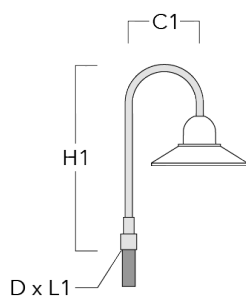

Pole mounted

Description	Part ID	C1	D x L1	H1	H2	M1	Weight (kg)	C	H
BA2-420 Pole bracket, double	300-0104	500	76 x 80	1000			8	500	1000

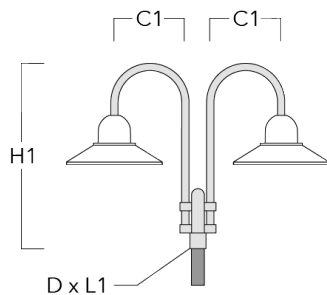

BA3-420 Pole bracket, triple	300-0109	500	76 x 80	1000			10	500	1000
------------------------------	----------	-----	---------	------	--	--	----	-----	------

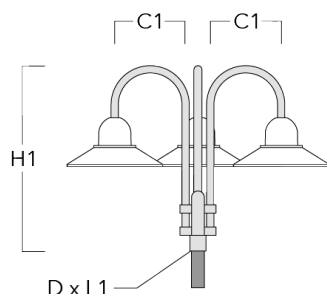

Wall and pole brackets BC

WE-EF LEUCHTEN GmbH

Töpinger Straße 16, 29646 Bispingen, Germany - Phone: +49 5194 909-0

info@we-ef.com - <https://we-ef.com>

Subject to technical changes and errors. - Generated on 23/10/2024

Pole mounted

Description	Part ID	C1	H1	H2	M1	Weight (kg)	C	H
BC0-420 Wall bracket, single	300-0808	460	1230	300	8	2.30	460	1230

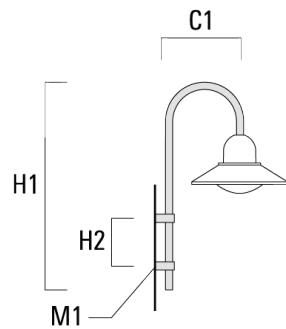

BC1-420 Pole bracket, single	300-0768	500	1230	300	8	2.30	500	1230
------------------------------	----------	-----	------	-----	---	------	-----	------

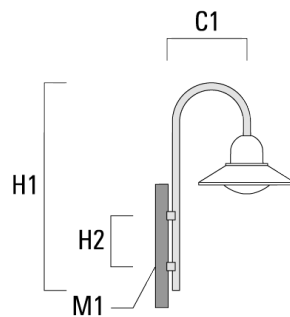

Pole mounted

Description	Part ID	C1	H1	H2	M1	Weight (kg)	C	H
BC2-420 Pole bracket, double	300-0767	500	1230	300	8	4.60	500	1230

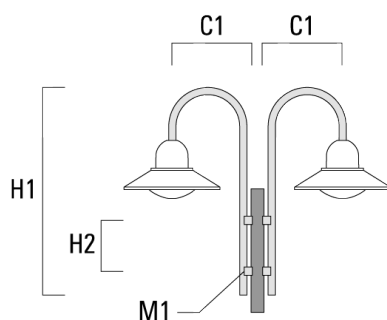

Wall and pole brackets DA

Description	Part ID	C1	C2	D × L1	H1	Weight (kg)	C	H
DA0-500 Wall bracket, single	300-0146	510	70		650	5.70	510	650

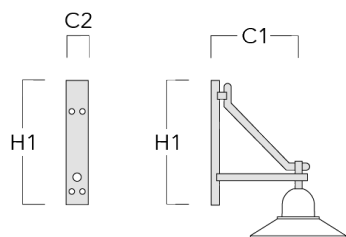

Pole mounted

Description	Part ID	C1	C2	D x L1	H1	Weight (kg)	C	H
DA1-500 Pole bracket, single	300-0138	510		76 x 80	700	5.70	510	700

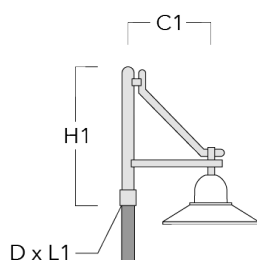

DA2-500 Pole bracket, double	300-0141	510		76 x 80	700	8.30	510	700
------------------------------	----------	-----	--	---------	-----	------	-----	-----

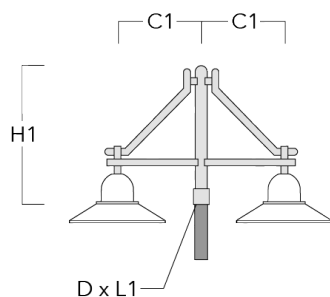

Pole mounted

Description	Part ID	C1	C2	D × L1	H1	Weight (kg)	C	H
DA3-500 Pole bracket, triple	300-0144	510		76 x 80	700	10.90	510	700

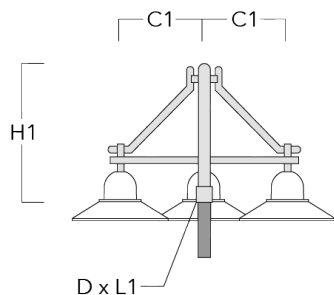

Wall and pole brackets DB

Description	Part ID	C1	C2	D × L1	H1	Weight (kg)	C	H
DB0-500 Wall bracket, single	300-0169	510	70		650	5.50	510	650

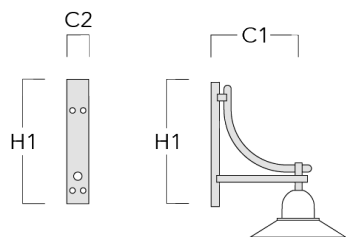

Pole mounted

Description	Part ID	C1	C2	D x L1	H1	Weight (kg)	C	H
DB1-500 Pole bracket, single	300-0190	510		76 x 80	700	5.50	510	700

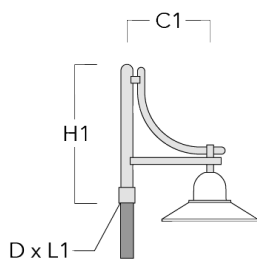

DB2-500 Pole bracket, double	300-0191	510		76 x 80	700	7.90	510	700
------------------------------	----------	-----	--	---------	-----	------	-----	-----

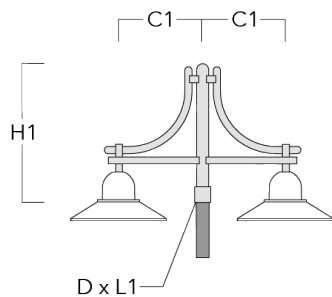

Pole mounted

Description	Part ID	C1	C2	D × L1	H1	Weight (kg)	C	H
DB3-500 Pole bracket, triple	300-0192	510		76 x 80	700	10.30	510	700

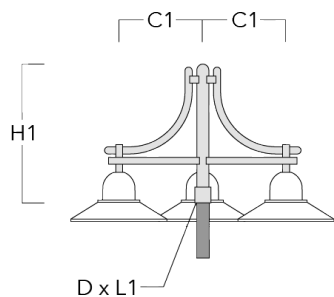

Wall and pole brackets DS

Description	Part ID	C1	C2	D × L1	H1	Weight (kg)	C	H
DS0-500 Wall bracket, single	300-0064	510	70		650	2.50	510	650

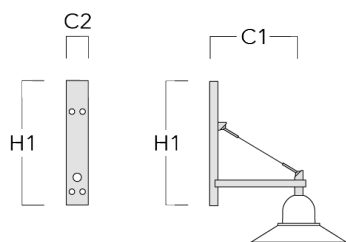

Pole mounted

Description	Part ID	C1	C2	D x L1	H1	Weight (kg)	C	H
DS1-500 Pole bracket, single	300-0063	510		76 x 80	725	3.90	510	725

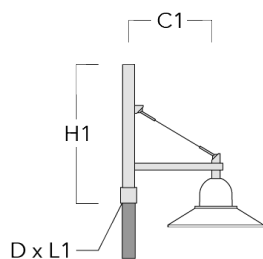

DS2-500 Pole bracket, double	300-0066	510		76 x 80	725	5.30	510	725
------------------------------	----------	-----	--	---------	-----	------	-----	-----

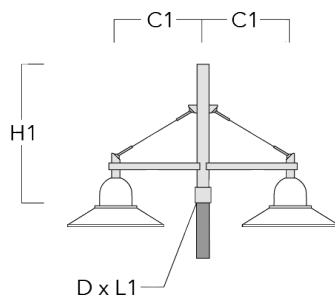

ASP534 LED

Pole mounted

Description	Part ID	C1	C2	D x L1	H1	Weight (kg)	C	H
DS3-500 Pole bracket, triple	300-0069	510		76 x 80	725	6.70	510	725

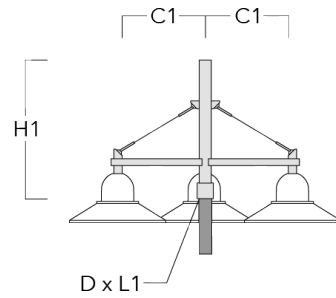

ASP534 LED

Pole mounted

we-ef

Optical Accessories

Light shield

Description	Part ID	Additional information
LS180	430-0029	Glare Shield for backlight spill. Glare Shield factory-installed or available as retrofit kit. Suitable for [S60], [S65], [S70], [R65], [P65] lenses. Must be specified at time of ordering.

WE-EF LEUCHTEN GmbH

Töpinger Straße 16, 29646 Bispingen, Germany - Phone: +49 5194 909-0

info@we-ef.com - <https://we-ef.com>

Subject to technical changes and errors. - Generated on 23/10/2024

ASP534 LED

Pole mounted

WE-EF LEUCHTEN GmbH

Töpinger Straße 16, 29646 Bispingen, Germany

Phone: +49 5194 909-0

info@we-ef.com

<https://we-ef.com>

Subject to technical changes and errors.

Generated on 23/10/2024