

LTM440 LED-FT

Light columns

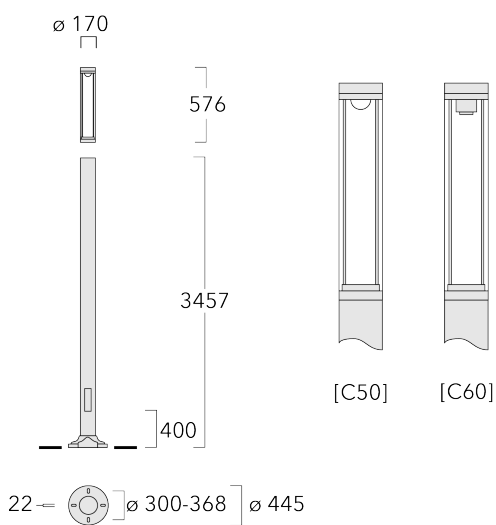





Description

IP66, Class I. Class II on request. IK10. Marine-grade die-cast aluminium alloy. 5CE superior corrosion protection including PCS hardware. Silicone CCG® Controlled Compression Gasket. Polycarbonate main lens. CAD-optimised optics for superior illumination and glare control.

Service door with fused cable connecting box.

Specifications

Material description

Body	Marine-grade, all-aluminium construction
Lens	Polycarbonate lens
Colours	 RAL9004 Signal black  RAL9006 White aluminium  RAL9007 Grey aluminium  RAL7016 Anthracite grey  RAL9016 Traffic white
Gasket	Silicone CCG® Controlled Compression Gasket
Fasteners	PCS Polymer Coated Stainless Steel hardware
Ingress protection	IP66
Impact resistance	IK10
Corrosion resistance	5CE

Electrical description

Power supply	220-240V / 50-60 Hz
Driver / Ballast	Integral EC electronic converter
Surge protection	10/10kV

Additional information

Lifetime	Ta=25° L70B50 > 50000h
Energy efficiency class	B-C (Light source)



LTM440 LED-FT

Light columns



we-ef

Options

Light distribution

	symmetric distribution [C60]
	controlled symmetric distribution [C50]
	rectangular [R50]

Colour temperature



	3000 K
	4000 K
	2700 K

Nominal Watt

2 W
27 W

Light columns

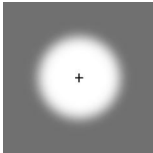
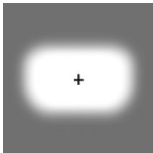
Configurations

Light distribution	Part ID	Light source	Rated lumens	Rated input power	CRI	Weight (kg)
controlled symmetric distribution [C50] 	115-1521	LED-FT-17W / 500 mA - 3000 K	2508.1	20 W	80	25.00
	115-1522	LED-FT-17W / 500 mA - 4000 K	2614.3	20 W	80	25.00
	115-1523	LED-FT-24W / 700 mA - 3000 K	3447.6	27 W	80	25.00
	115-1524	LED-FT-24W / 700 mA - 4000 K	3594.6	27 W	80	25.00
	115-1565	LED-FT-37W / 700 mA - 3000 K	5171.3	42 W	80	25.00
	115-1566	LED-FT-37W / 700 mA - 4000 K	5469.5	42 W	80	25.00
	115-1778	LED-FT-17W / 500 mA - 2700 K	2397.8	20 W	80	25.00
	115-1779	LED-FT-24W / 700 mA - 2700 K	3308.7	27 W	80	25.00
	115-1837	LED-FT-37W / 700 mA - 2700 K	5020.2	42 W	80	25.00
rectangular [R50] 	115-1840	LED-FT-17W / 500 mA - 3000 K	2403.3	20 W	80	25.00
	115-1845	LED-FT-17W / 500 mA - 4000 K	2505.1	20 W	80	25.00
	115-1846	LED-FT-17W / 500 mA - 2700 K	2297.6	20 W	80	25.00
	115-1847	LED-FT-24W / 700 mA - 3000 K	3303.6	27 W	80	25.00
	115-1848	LED-FT-24W / 700 mA - 4000 K	3444.5	27 W	80	25.00
	115-1849	LED-FT-24W / 700 mA - 2700 K	3170.5	27 W	80	25.00
	115-1850	LED-FT-37W / 700 mA - 3000 K	4955.4	42 W	80	25.00
	115-1851	LED-FT-37W / 700 mA - 4000 K	5241.1	42 W	80	25.00
	115-1852	LED-FT-37W / 700 mA - 2700 K	4810.5	42 W	80	25.00
symmetric distribution [C60] 	115-1517	LED-FT-17W / 500 mA - 3000 K	2071.2	20 W	80	25.00
	115-1518	LED-FT-17W / 500 mA - 4000 K	2158.9	20 W	80	25.00
	115-1519	LED-FT-24W / 700 mA - 3000 K	2847	27 W	80	25.00
	115-1520	LED-FT-24W / 700 mA - 4000 K	2968.4	27 W	80	25.00
	115-1563	LED-FT-37W / 700 mA - 3000 K	4270.5	42 W	80	25.00
	115-1564	LED-FT-37W / 700 mA - 4000 K	4516.7	42 W	80	25.00
	115-1780	LED-FT-17W / 500 mA - 2700 K	1980.1	20 W	80	25.00
	115-1781	LED-FT-24W / 700 mA - 2700 K	2732.3	27 W	80	25.00
	115-1838	LED-FT-37W / 700 mA - 2700 K	4145.7	42 W	80	25.00

Mounting Accessories

Planted root

Description	Part ID	D1	D2	D3	D4	H1	H2	M1	Weight (kg)
Planted root ESV10	300-0949	415	340	126	133	1000	500	18	25.30

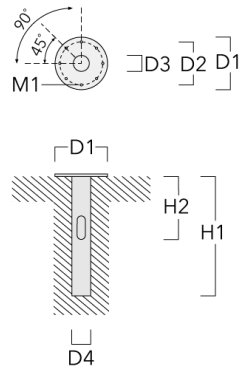

Optical Accessories

Light shield

Description	Part ID
LS180-[C60]	159-0321