

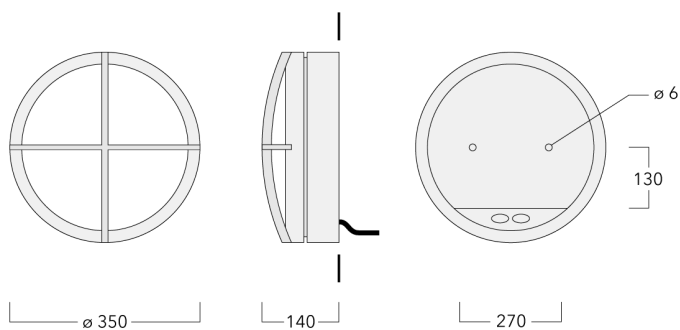





**Beschreibung**

IP55, SKI. SKII auf Anfrage. IK10. Korrosionsbeständiger Aluminiumguss. PCS beschichtete Edelstahlschrauben. 5CE Korrosionsschutz. Silikondichtung. Polycarbonat Abdeckung. Zwei Kabeleinführungen. Eingebaute elektronische Betriebsgeräte. Eingebaute LED Platine.



Spezifikationen**Materialbeschreibung**

Gehäuse	Korrosionsbeständiger Aluminiumguss
Abdeckung	Polycarbonat
Farben	 RAL9004 Signalschwarz  RAL9006 Weißaluminium  RAL9007 Graualuminium  RAL7016 Anthrazitgrau  RAL9016 Verkehrsweiß
Dichtung	Silikondichtung
Schrauben	PCS beschichtete Edelstahlschrauben
Schutzart	IP55
Schlagfestigkeit	IK10
Korrosionsbeständigkeit	5CE

Elektrische Beschreibung

Netz	220-240V / 50-60 Hz
Netzgerät / Vorschaltgerät	Eingebaute elektronische Betriebsgeräte
Überspannungsschutz	1/2 kV

Weitere Informationen

Lebensdauer	Ta=25° L70B50 > 50000h
Energieeffizienzklasse	D (Lichtquelle)

DLG239 LED

Wandaufbauleuchten

Auswahl

Lichtverteilung



diffus streuend

Farbtemperaturen



3000 K



4000 K



2700 K

Nominal Watt

27 W

Konfigurationen

Lichtverteilung	Artikelnummer	Lichtquelle	Bemes- sungslicht- strom	Bemes- sungsleis- tung	CRI	Gewicht (kg)
diffus streuend 	195-0896	LED-FT-28W / 800 mA - 2700 K	1457.7	31 W	80	3.60
	195-9539	LED-FT-28W / 800 mA - 3000 K	1518.3	31 W	80	3.60
	195-9540	LED-FT-28W / 800 mA - 4000 K	1585.3	31 W	80	3.60