

OLV330 LED

Wall luminaires surface mounted

we-ef



Fagerhult Lighting Ltd

33-34 Dolben Street, SE1 0UQ London, United Kingdom

<https://we-ef.com/uk>

Subject to technical changes and errors. - Generated on 23/11/2024

OLV330 LED

Wall luminaires surface mounted

we-ef

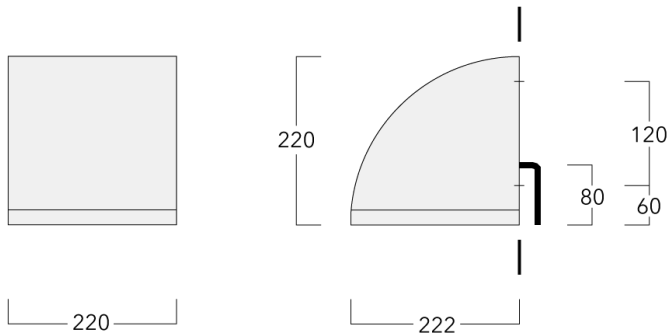

Description

IP65, Class I. Class II on request. IK07. Marine-grade, die-cast aluminium alloy. 5CE superior corrosion protection including PCS hardware. Silicone CCG® Controlled Compression Gasket. Safety glass lens. Two cable entries. Integral EC electronic converter. CAD-optimised optics for superior illumination and glare control. OLC® One LED Concept. Factory installed LED circuit board. 1-10V or DALI interface on request. Optional 2200 K version available. To be specified at time of ordering.

Can be mounted up or down.





Fagerhult Lighting Ltd

33-34 Dolben Street, SE1 0UQ London, United Kingdom

<https://we-ef.com/uk>

Subject to technical changes and errors. - Generated on 23/11/2024

Wall luminaires surface mounted**Specifications****Material description**

Body	Marine-grade die-cast aluminium alloy
Lens	Safety glass lens
Colours	 RAL9004 Signal black  RAL9006 White aluminium  RAL9007 Grey aluminium  RAL7016 Anthracite grey  RAL9016 Traffic white
Gasket	Silicone CCG® Controlled Compression Gasket
Fasteners	PCS Polymer Coated Stainless Steel Hardware
Ingress protection	IP65
Impact resistance	IK07
Corrosion resistance	5CE

Electrical description

Power supply	220-240V / 50-60 Hz
Driver / Ballast	Standard. Optional DALI version available. To be specified at time of ordering.
Surge protection	1/2 kV (optional SP10)

Additional information

Lifetime	Ta=25° L90B10 > 90000h
Energy efficiency class	C-D (Light source)

OLV330 LED

Wall luminaires surface mounted

we-ef

Options

Light distribution



symmetric, medium beam [M]



symmetric, very narrow beam, sharp cut-off [EES]

Colour temperature



3000 K



4000 K



2700 K

Nominal Watt

15 W

21 W

0 W

Configurations

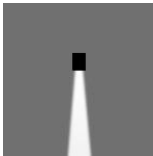
Light distribution	Part ID	Light source	Rated lumens	Rated input power	CRI	Weight (kg)
symmetric, medium beam [M] 	132-0522	LED-12/12W / 350 mA - 3000 K	1602.7	13.9 W	80	6.60
	132-0523	LED-12/12W / 350 mA - 4000 K	1757.8	13.9 W	80	6.60
	132-0532	LED-12/18W / 500 mA - 3000 K	2223.1	21 W	80	6.60
	132-0533	LED-12/18W / 500 mA - 4000 K	2378.2	21 W	80	6.60
	132-0633	LED-12/12W / 350 mA - 2700 K	1499.3	13.9 W	80	6.60
	132-0634	LED-12/18W / 500 mA - 2700 K	2068	21 W	80	6.60
symmetric, very narrow beam, sharp cut-off [EES] 	132-0524	LED-12/12W / 350 mA - 3000 K	1645.1	13.9 W	80	6.60
	132-0525	LED-12/12W / 350 mA - 4000 K	1804.3	13.9 W	80	6.60
	132-0534	LED-12/18W / 500 mA - 3000 K	2281.9	21 W	80	6.60
	132-0535	LED-12/18W / 500 mA - 4000 K	2441.1	21 W	80	6.60
	132-0635	LED-12/12W / 350 mA - 2700 K	1539	13.9 W	80	6.60
	132-0636	LED-12/18W / 500 mA - 2700 K	2122.7	21 W	80	6.60

Wall luminaires surface mounted**Control****DALI interface**

Description	Part ID	Additional information	C
DALI interface	430-0013	DALI variant. The luminaire is equipped with a DT6 Dali driver (Dali 2.0).	90

Dali 2.0

- Application controllers and Input devices defined
- Single-masters and multi-masters allowed
- Event priorities defined
- Separate addressing & grouping from control gear

Note: Mixing Dali 1 and Dali 2.0 drivers can cause problems because the addressing and the command scope has changed!