

OLV330 LED

Appliques murales

we-ef



WE-EF Switzerland AG

Himmelrichstrasse 6, 6003 Luzern - Téléphone: +41 22 752 49 94

info.switzerland@we-ef.com - https://we-ef.com/ch_fr

Sous réserve de modifications techniques et d'erreurs. - Généré le 23/11/2024

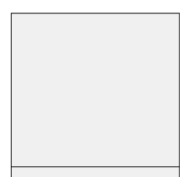



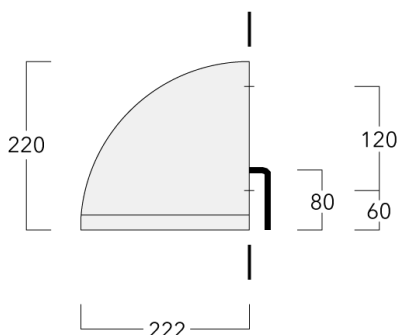

220

**Description**

IP65, Classe I. Classe II sur demande. IK07. Corps en fonte d'aluminium. Visserie inox avec traitement PCS. Protection contre la corrosion 5CE. Joint silicone. Verre de sécurité. Deux entrées de câble. Version en 2200K disponible. À préciser lors de la demande de devis.

Montage en éclairage direct ou indirect.

Spécifications**Description du matériel**

Corps	Corps en fonte d'aluminium
Lentille	Verre de sécurité
Couleurs	 RAL9004 Noir de sécurité  RAL9007 Aluminium gris  RAL7016 Gris anthracite  RAL9016 Blanc signalisation
Joint	Joint silicone CCG®
Visserie	PCS Inox avec recouvrement polymère
IP	IP65
IK	IK07
Protection contre la corrosion	5CE

Description électrique

Alimentation électrique	220-240V / 50-60 Hz
Driver	Standard - version DALI disponible en option

Informations complémentaires

Durée de vie	Ta=25° L90B10 > 90000h
Classe d'efficacité énergétique	C-D

OLV330 LED

Appliques murales

we-ef

Options

Distribution de la lumière



symmetric, medium beam [M]



faisceau symétrique, ultra intensif, 'cut-off' [EES]

Température de couleur



3000 K



4000 K



2700 K

Données en sortie de luminaire

15 W

21 W

0 W



WE-EF Switzerland AG

Himmelrichstrasse 6, 6003 Luzern - Téléphone: +41 22 752 49 94

info.switzerland@we-ef.com - https://we-ef.com/ch_fr

Sous réserve de modifications techniques et d'erreurs. - Généré le 23/11/2024

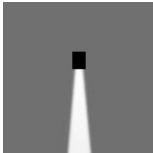
Configurations

Distribution de la lumière	Référence	Source lumineuse	Rated lumens	Rated input power	IRC	Poids (kg)
faisceau symétrique, ultra intensif, 'cut-off' [EES] 	132-0524	LED-12/12W / 350 mA - 3000 K	1645.1	13.9 W	80	6.60
	132-0525	LED-12/12W / 350 mA - 4000 K	1804.3	13.9 W	80	6.60
	132-0534	LED-12/18W / 500 mA - 3000 K	2281.9	21 W	80	6.60
	132-0535	LED-12/18W / 500 mA - 4000 K	2441.1	21 W	80	6.60
	132-0635	LED-12/12W / 350 mA - 2700 K	1539	13.9 W	80	6.60
	132-0636	LED-12/18W / 500 mA - 2700 K	2122.7	21 W	80	6.60
symmetric, medium beam [M] 	132-0522	LED-12/12W / 350 mA - 3000 K	1602.7	13.9 W	80	6.60
	132-0523	LED-12/12W / 350 mA - 4000 K	1757.8	13.9 W	80	6.60
	132-0532	LED-12/18W / 500 mA - 3000 K	2223.1	21 W	80	6.60
	132-0533	LED-12/18W / 500 mA - 4000 K	2378.2	21 W	80	6.60
	132-0633	LED-12/12W / 350 mA - 2700 K	1499.3	13.9 W	80	6.60
	132-0634	LED-12/18W / 500 mA - 2700 K	2068	21 W	80	6.60

Control**DALI interface**

Description	Référence	Informations complémentaires	C
DALI interface	430-0013	DALI variant. The luminaire is equipped with a DT6 Dali driver (Dali 2.0).	90

Dali 2.0

- Application controllers and Input devices defined
- Single-masters and multi-masters allowed
- Event priorities defined
- Separate addressing & grouping from control gear

Note: Mixing Dali 1 and Dali 2.0 drivers can cause problems because the addressing and the command scope has changed!