

BSP544 LED

Pole mounted

we-ef

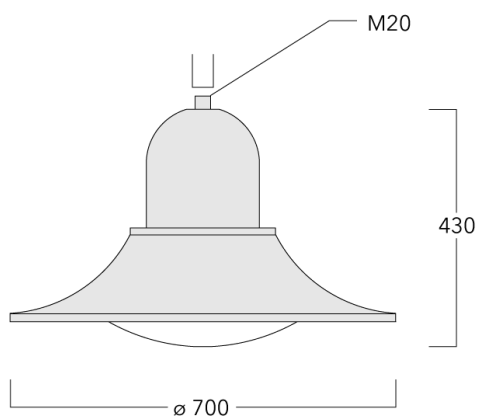

Description

IP55, Class I. Cass II on request. IK10. Marine-grade, die-cast aluminium alloy. 5CE superior corrosion protection including PCS hardware. Silicone rubber gasket. Polycarbonate main lens. Integral EC electronic converter in thermally separated compartment. CAD-optimised optics for superior illumination and glare control. OLC® One LED Concept. Factory installed LED circuit board. The luminaire is factory-sealed and does not need to be opened during installation.

Optional 2200 K version available. To be specified at time of ordering.

Brackets to be ordered separately.

WE-EF LEUCHTEN GmbH

Töpinger Straße 16, 29646 Bispingen, Germany - Phone: +49 5194 909-0
info@we-ef.com - <https://we-ef.com>

Subject to technical changes and errors. - Generated on 23/11/2024





BSP544 LED

Pole mounted

we-ef

Specifications

Material description

| | |
|----------------------|---|
| Body | Marine-grade, die-cast aluminium alloy |
| Lens | Polycarbonate lens |
| Colours |  RAL9004 Signal black  RAL9006 White aluminium  RAL9007 Grey aluminium  RAL7016 Anthracite grey  RAL9016 Traffic white |
| Gasket | Silicone rubber gasket |
| Fasteners | PCS Polymer Coated Stainless Steel Hardware |
| Ingress protection | IP55 |
| Impact resistance | IK10 |
| Corrosion resistance | 5CE |
| Windage | 0.1246 m ² |

Electrical description

| | |
|------------------|--|
| Power supply | 220-240V / 50-60 Hz |
| Driver / Ballast | Integral EC electronic converter. DALI |
| Power factor | > 0.9 |
| Surge protection | 6/6 kV (optional SP10) |

Additional information

| | |
|-------------------------|------------------------|
| Lifetime | Ta=25° L90B10 > 90000h |
| Energy efficiency class | C-D (Light source) |

WE-EF LEUCHTEN GmbH

Töpinger Straße 16, 29646 Bispingen, Germany - Phone: +49 5194 909-0
info@we-ef.com - <https://we-ef.com>

Subject to technical changes and errors. - Generated on 23/11/2024

BSP544 LED

Pole mounted

Options

Light distribution



asymmetric, side throw beam [S65]



rectangular, side throw [R65]

Colour temperature



3000 K



4000 K



2700 K

Nominal Watt

58 W

86 W

Configurations

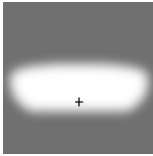
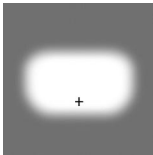
| Light distribution | Part ID | Light source | Rated lumens | Rated input power | CRI | Weight (kg) |
|---|--|------------------------------|------------------------------|-------------------|------|-------------|
| asymmetric, side throw beam [S65]  | 127-1302 | LED-24/48W / 700 mA - 3000 K | 5920.9 | 54 W | 80 | 13.10 |
| | 127-1302-70 | LED-24/48W / 700 mA - 3000 K | 6737.6 | 54 W | 70 | 13.10 |
| | 127-1303 | LED-24/48W / 700 mA - 4000 K | 6329.3 | 54 W | 80 | 13.10 |
| | 127-1303-70 | LED-24/48W / 700 mA - 4000 K | 7146 | 54 W | 70 | 13.10 |
| | 127-1304 | LED-36/72W / 700 mA - 3000 K | 8881.4 | 79 W | 80 | 13.10 |
| | 127-1304-70 | LED-36/72W / 700 mA - 3000 K | 10106.4 | 79 W | 70 | 13.10 |
| | 127-1305 | LED-36/72W / 700 mA - 4000 K | 9493.9 | 79 W | 80 | 13.10 |
| | 127-1305-70 | LED-36/72W / 700 mA - 4000 K | 10718.9 | 79 W | 70 | 13.10 |
| | 127-1433 | LED-24/48W / 700 mA - 2700 K | 5512.6 | 54 W | 80 | 13.10 |
| | 127-1433-70 | LED-24/48W / 700 mA - 2700 K | 5920.9 | 54 W | 70 | 13.10 |
| | 127-1434 | LED-36/72W / 700 mA - 2700 K | 8268.9 | 79 W | 80 | 13.10 |
| | 127-1434-70 | LED-36/72W / 700 mA - 2700 K | 8881.4 | 79 W | 70 | 13.10 |
| | rectangular, side throw [R65]  | 127-1306 | LED-24/48W / 700 mA - 3000 K | 5398.9 | 54 W | 80 |
| 127-1306-70 | | LED-24/48W / 700 mA - 3000 K | 6143.5 | 54 W | 70 | 13.10 |
| 127-1307 | | LED-24/48W / 700 mA - 4000 K | 5771.2 | 54 W | 80 | 13.10 |
| 127-1307-70 | | LED-24/48W / 700 mA - 4000 K | 6515.9 | 54 W | 70 | 13.10 |
| 127-1308 | | LED-36/72W / 700 mA - 3000 K | 8098.3 | 79 W | 80 | 13.10 |
| 127-1308-70 | | LED-36/72W / 700 mA - 3000 K | 9215.3 | 79 W | 70 | 13.10 |
| 127-1309 | | LED-36/72W / 700 mA - 4000 K | 8656.8 | 79 W | 80 | 13.10 |
| 127-1309-70 | | LED-36/72W / 700 mA - 4000 K | 9773.8 | 79 W | 70 | 13.10 |
| 127-1435 | | LED-24/48W / 700 mA - 2700 K | 5026.5 | 54 W | 80 | 13.10 |
| 127-1435-70 | | LED-24/48W / 700 mA - 2700 K | 5398.9 | 54 W | 70 | 13.10 |
| 127-1436 | | LED-36/72W / 700 mA - 2700 K | 7539.8 | 79 W | 80 | 13.10 |
| 127-1436-70 | | LED-36/72W / 700 mA - 2700 K | 8098.3 | 79 W | 70 | 13.10 |

BSP544 LED

Pole mounted

Control

Eco Step Dim® Basic

| Description | Part ID |
|-------------------------|----------|
| Eco Step Dim® Basic LED | 430-0001 |

Eco Step Dim® Advanced

| Description | Part ID |
|----------------------------|----------|
| Eco Step Dim® Advanced LED | 430-0002 |

Mounting Accessories

Wall and pole brackets BA

| Description | Part ID | C1 | D x L1 | H1 | H2 | M1 | Weight (kg) | C | H |
|------------------------------|----------|-----|--------|------|-----|----|-------------|-----|------|
| BA0-580 Wall bracket, single | 300-0149 | 635 | | 1000 | 132 | 9 | 2.50 | 635 | 1000 |

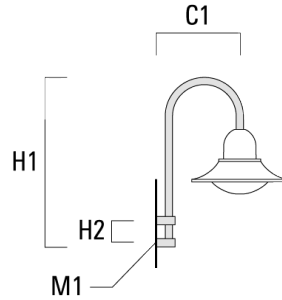

| | | | | | | | | | |
|------------------------------|----------|-----|---------|------|--|--|------|-----|------|
| BA1-580 Pole bracket, single | 300-0089 | 580 | 76 x 80 | 1000 | | | 4.50 | 580 | 1000 |
|------------------------------|----------|-----|---------|------|--|--|------|-----|------|

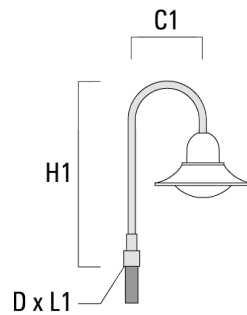

Pole mounted

| Description | Part ID | C1 | D x L1 | H1 | H2 | M1 | Weight (kg) | C | H |
|------------------------------|----------|-----|---------|------|----|----|-------------|-----|------|
| BA2-580 Pole bracket, double | 300-0090 | 675 | 76 x 80 | 1000 | | | 8.50 | 675 | 1000 |

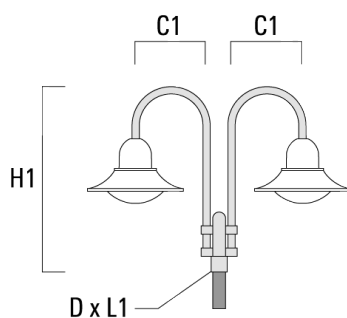

| | | | | | | | | | |
|------------------------------|----------|-----|---------|------|--|--|-------|-----|------|
| BA3-580 Pole bracket, triple | 300-0093 | 675 | 76 x 80 | 1000 | | | 10.50 | 675 | 1000 |
|------------------------------|----------|-----|---------|------|--|--|-------|-----|------|

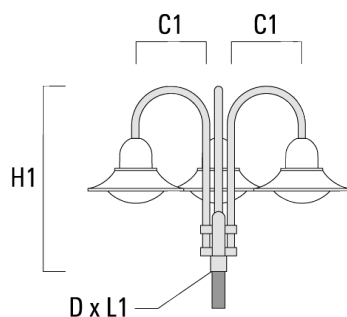

Wall and pole brackets BC

| Description | Part ID | C1 | H1 | H2 | M1 | Weight (kg) | C | H |
|------------------------------|----------|-----|------|-----|----|-------------|-----|------|
| BC0-580 Wall bracket, double | 300-0771 | 635 | 1325 | 300 | 8 | 2.80 | 635 | 1325 |

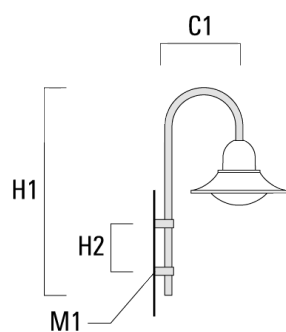

| | | | | | | | | |
|------------------------------|----------|-----|------|-----|---|------|-----|------|
| BC1-580 Pole bracket, single | 300-0770 | 675 | 1325 | 300 | 8 | 2.80 | 675 | 1325 |
|------------------------------|----------|-----|------|-----|---|------|-----|------|

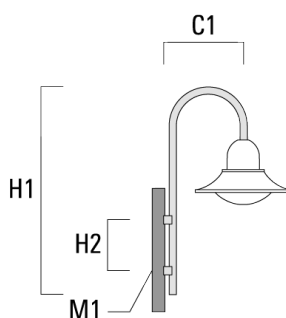

Pole mounted

| Description | Part ID | C1 | H1 | H2 | M1 | Weight (kg) | C | H |
|------------------------------|----------|-----|------|-----|----|-------------|-----|------|
| BC2-580 Pole bracket, double | 300-0769 | 675 | 1325 | 300 | 8 | 5.60 | 675 | 1325 |

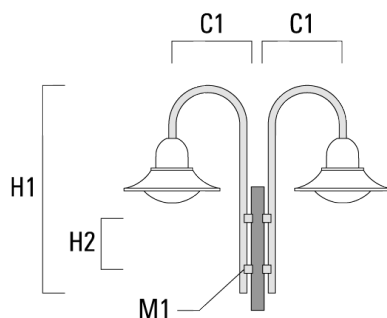

Wall and pole brackets DA

| Description | Part ID | C1 | C2 | D × L1 | H1 | Weight (kg) | C | H |
|------------------------------|----------|-----|----|--------|-----|-------------|-----|-----|
| DA0-750 Wall bracket, single | 300-0086 | 720 | 70 | | 950 | 7.30 | 720 | 950 |

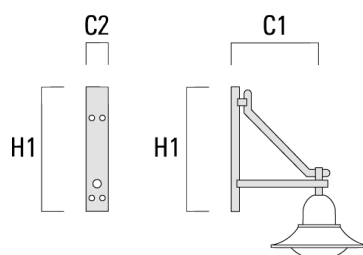

Pole mounted

| Description | Part ID | C1 | C2 | D x L1 | H1 | Weight (kg) | C | H |
|------------------------------|----------|-----|----|----------|-----|-------------|-----|-----|
| DA1-750 Pole bracket, single | 300-0083 | 720 | | 76 x 130 | 950 | 7.30 | 720 | 950 |

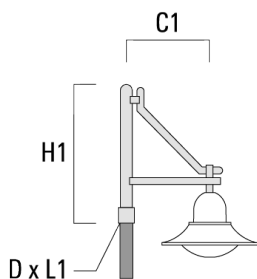

| | | | | | | | | |
|------------------------------|----------|-----|--|----------|-----|-------|-----|-----|
| DA2-750 Pole bracket, double | 300-0084 | 720 | | 76 x 130 | 950 | 10.60 | 720 | 950 |
|------------------------------|----------|-----|--|----------|-----|-------|-----|-----|

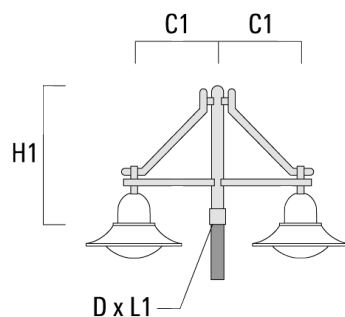

BSP544 LED

Pole mounted

| Description | Part ID | C1 | C2 | D × L1 | H1 | Weight (kg) | C | H |
|------------------------------|----------|-----|----|----------|-----|-------------|-----|-----|
| DA3-750 Pole bracket, triple | 300-0085 | 720 | | 76 x 130 | 950 | 13.90 | 720 | 950 |

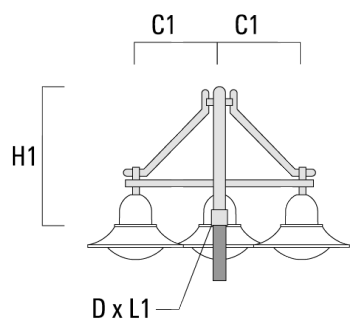

Wall and pole brackets DB

| Description | Part ID | C1 | C2 | D × L1 | H1 | Weight (kg) | C | H |
|------------------------------|----------|-----|----|--------|-----|-------------|-----|-----|
| DB0-750 Wall bracket, single | 300-0172 | 720 | 70 | | 950 | 7.10 | 720 | 950 |

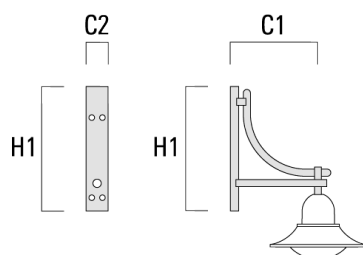

WE-EF LEUCHTEN GmbH

Töpinger Straße 16, 29646 Bispingen, Germany - Phone: +49 5194 909-0
info@we-ef.com - <https://we-ef.com>

Subject to technical changes and errors. - Generated on 23/11/2024

Pole mounted

| Description | Part ID | C1 | C2 | D x L1 | H1 | Weight (kg) | C | H |
|------------------------------|----------|-----|----|----------|-----|-------------|-----|-----|
| DB1-750 Pole bracket, single | 300-0165 | 720 | | 76 x 130 | 950 | 7.10 | 720 | 950 |

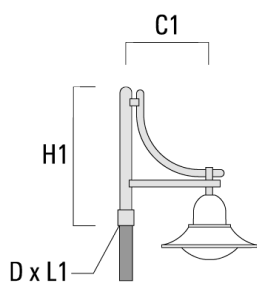

| | | | | | | | | |
|------------------------------|----------|-----|--|----------|-----|-------|-----|-----|
| DB2-750 Pole bracket, double | 300-0168 | 720 | | 76 x 130 | 950 | 10.20 | 720 | 950 |
|------------------------------|----------|-----|--|----------|-----|-------|-----|-----|

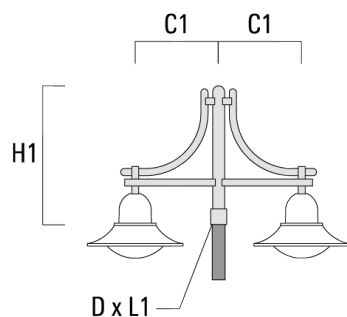

Pole mounted

| Description | Part ID | C1 | C2 | D × L1 | H1 | Weight (kg) | C | H |
|------------------------------|----------|-----|----|----------|-----|-------------|-----|-----|
| DB3-750 Pole bracket, triple | 300-0170 | 720 | | 76 x 130 | 950 | 13.30 | 720 | 950 |

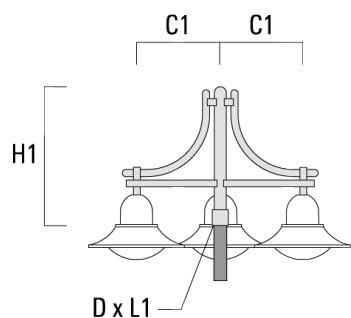

Wall and pole brackets DS

| Description | Part ID | C1 | C2 | D × L1 | H1 | Weight (kg) | C | H |
|------------------------------|----------|-----|----|--------|-----|-------------|-----|-----|
| DS0-750 Wall bracket, single | 300-0070 | 750 | 70 | | 700 | 2.60 | 750 | 700 |

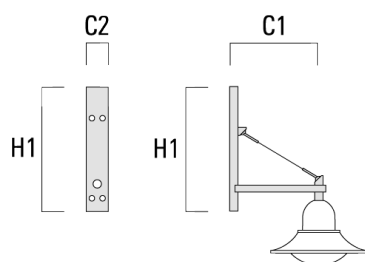

Pole mounted

| Description | Part ID | C1 | C2 | D x L1 | H1 | Weight (kg) | C | H |
|------------------------------|----------|-----|----|----------|-----|-------------|-----|-----|
| DS1-750 Pole bracket, single | 300-0477 | 750 | | 76 x 130 | 850 | 5.50 | 750 | 850 |

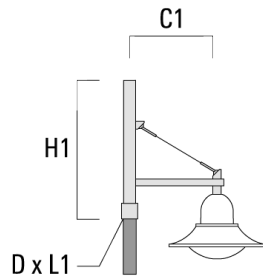

| | | | | | | | | |
|------------------------------|----------|-----|--|----------|-----|------|-----|-----|
| DS2-750 Pole bracket, double | 300-0765 | 750 | | 76 x 130 | 850 | 7.20 | 750 | 850 |
|------------------------------|----------|-----|--|----------|-----|------|-----|-----|

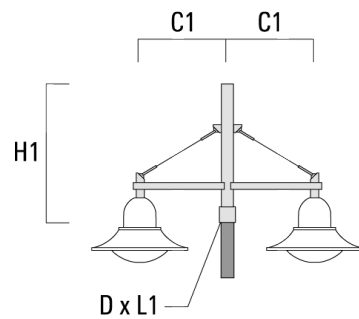

BSP544 LED

Pole mounted

| Description | Part ID | C1 | C2 | D x L1 | H1 | Weight (kg) | C | H |
|------------------------------|----------|-----|----|----------|-----|-------------|-----|-----|
| DS3-750 Pole bracket, triple | 300-0766 | 750 | | 76 x 130 | 850 | 8.90 | 750 | 850 |

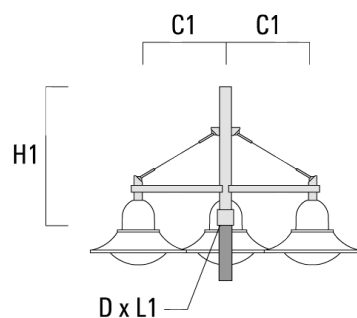

BSP544 LED

Pole mounted

Optical Accessories

Light shield

| Description | Part ID | Additional information |
|-------------|----------|--|
| LS180 | 430-0029 | Glare Shield for backlight spill. Glare Shield factory-installed or available as retrofit kit. Suitable for [S60], [S65], [S70], [R65], [P65] lenses. Must be specified at time of ordering. |