

ZFT430-FT LED

Street and Area Lighting

we-ef

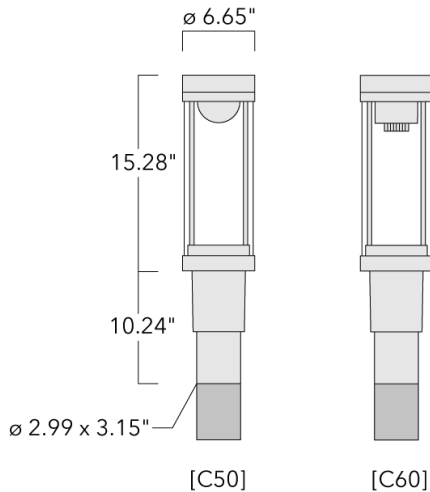

Description

Post top luminaire with shielded light source and canopy highlight feature.

IP66. Class I. IK09. Marine-grade, die-cast aluminum alloy. 5CE superior corrosion protection including PCS hardware. Silicone CCG® Controlled Compression Gasket. PMMA main lens. CAD-optimized indirect optics for superior illumination and glare control. Integral driver in thermally separated compartment. Factory-installed LED circuit board. 0-10V Dimming comes standard with luminaire. Luminaire is factory-sealed and does not need to be opened during installation.

Recommended mounting height 10-20 ft.

Specify product with 7 Digit product code - Finish Color. Accessories, such as mounting, optical, and electrical, must be specified separately.

Example: XXX-XXXX-9004 (Black)
+ XXX-XXXX (Accessory 1)

WE-EF LIGHTING USA, LLC





410-D Keystone Drive, 15086 Warrendale, PA 15086 - Phone: +1 724 742 0030
customersupport.usa@we-ef.com - <https://we-ef.com/us>
Subject to technical changes and errors. - Generated on 11/23/2024

ZFT430-FT LED

Street and Area Lighting

Specifications

Material description

Body	Marine-grade, die-cast aluminum alloy.
Lens	Clear polycarbonate outer lens
Colors	 RAL9004 Black  RAL9007 Grey Metallic  RAL9016 White  RAL8019 Dark Bronze
Gasket	Silicone rubber gasket
Fasteners	PCS polymer coated stainless steel hardware
Ingress protection	IP66
Impact resistance	IK09
Corrosion resistance	5CE
Windage	0.104 m ²

Electrical description

Power supply	Integral [ECG] LED driver in 120V-277V
Driver / Ballast	Integral EC electronic converter
Power factor	> 0.9
Surge protection	In-line bracket 10kV Surge Protector

Additional information

Lifetime	Ta=25°/40° L70B50 > 50000h
BUG Rating	Please see individual Spec Sheets for classification of Backlight, Uplight and Glare.
Listings	ETL, UL-1598, CSA-C22.2#250.0. Suitable for Wet Locations.

WE-EF LIGHTING USA, LLC

410-D Keystone Drive, 15086 Warrendale, PA 15086 - Phone: +1 724 742 0030
customersupport.usa@we-ef.com - <https://we-ef.com/us>
Subject to technical changes and errors. - Generated on 11/23/2024

ZFT430-FT LED

Street and Area Lighting



Options

Light distribution



symmetric distribution [C60]



[C50] Type V Short

Color temperature



3000 K



4000 K



2700 K

Nominal Watt

27 W

2 W

42 W

24 W

WE-EF LIGHTING USA, LLC

410-D Keystone Drive, 15086 Warrendale, PA 15086 - Phone: +1 724 742 0030
customersupport.usa@we-ef.com - <https://we-ef.com/us>

Subject to technical changes and errors. - Generated on 11/23/2024

ZFT430-FT LED

Street and Area Lighting

Configurations

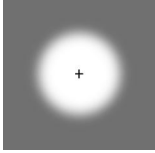
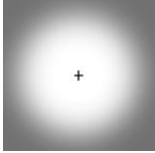
Light distribution	Part ID	Light source	Rated lumens	Rated input power	CRI	Weight (lb)
[C50] Type V Short 	115-1531	LED-FT 12W (3000K)	1698	14 W	80	11.91 lbs
	115-1532	LED-FT 12W (4000K)	1789.1	14 W	80	11.91 lbs
	115-1535	LED-FT-24W (3000K)	3495.5	27 W	80	11.91 lbs
	115-1536	LED-FT-24W (4000K)	3644.6	27 W	80	11.91 lbs
	115-1537	LED-FT-37W (3000K)	5243.2	42 W	80	11.91 lbs
	115-1538	LED-FT-37W (4000K)	5545.5	42 W	80	11.91 lbs
	115-1582	LED-FT-12W (2700K)	1590.4	14 W	80	11.91 lbs
	115-1583	LED-FT-24W (2700K)	3354.7	27 W	80	11.91 lbs
	115-1584	LED-FT-37W (2700K)	5090	42 W	80	11.91 lbs
symmetric distribution [C60] 	115-1241	LED-FT-24W (3000K)	2609.8	27 W	80	11.91 lbs
	115-1242	LED-FT-24W (4000K)	2721.1	27 W	80	11.91 lbs
	115-1283	LED-FT-37W (3000K)	3914.7	42 W	80	11.91 lbs
	115-1284	LED-FT-37W (4000K)	4140.4	42 W	80	11.91 lbs
	115-1343	LED-FT 12W (3000K)	1267.8	14 W	80	11.91 lbs
	115-1344	LED-FT 12W (4000K)	1335.8	14 W	80	11.91 lbs
	115-1585	LED-FT-12W (2700K)	1187.4	14 W	80	11.91 lbs
	115-1586	LED-FT-24W (2700K)	2504.7	27 W	80	11.91 lbs
	115-1620	LED-FT-37W (2700K)	3800.3	42 W	80	11.91 lbs

WE-EF LIGHTING USA, LLC

410-D Keystone Drive, 15086 Warrendale, PA 15086 - Phone: +1 724 742 0030

customersupport.usa@we-ef.com - <https://we-ef.com/us>

Subject to technical changes and errors. - Generated on 11/23/2024

Mounting Accessories

Wall and pole brackets RZ

Description	Part ID	C1	D1	D2	D x L1	M1	Weight (lb)
RZ0-400 Wall bracket, single	115-1324	10.90"	9.1"	7.67"	3" x 3"	0.47"	7.72 lbs

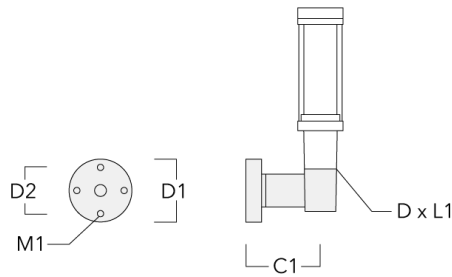

RZ2-400 Pole bracket, double	115-1323	10.16"			3" x 3"		10.8 lbs
------------------------------	----------	--------	--	--	---------	--	----------

