

ZFT430-FT LED

Pole mounted

we-ef

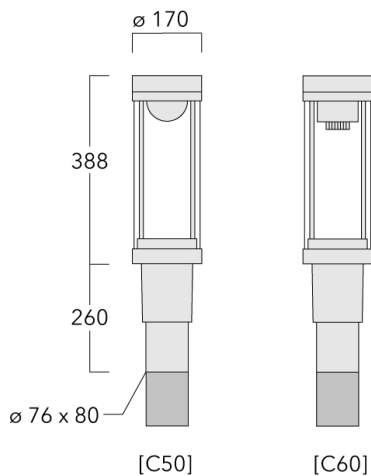

Description

IP66. Class I. IK09. Marine-grade, die-cast aluminium alloy. 5CE superior corrosion protection include PCS hardware. PMMA lens. Silicone CCG® Controlled Compression Gasket. Luminaire is factory-sealed and does not need to be opened during installation.

Integral electronic converter with DALI interface in thermally separated compartment. Advanced thermal management protects LEDs while optimising lumens output. Removable LED boards for upgrading. CAD-optimised optics for superior illumination and glare control.

Including 0.5 m cable with a cable connector.

Recommended mounting height 3.0 - 6.0 m.





WE-EF LIGHTING (Thailand) Co., Ltd.

57 Moo 5, Kingkaew Rd., Bangplee, 10540 Samutprakarn - Phone: +66 2 738 96 20 - Fax: +66 2 738 96 29

<https://we-ef.com/asia>

Subject to technical changes and errors. - Generated on 23/11/2024

Pole mounted**Specifications****Material description**

| | |
|----------------------|--|
| Body | Marine-grade, die-cast aluminium alloy |
| Lens | PMMA lens |
| Colours |  RAL9004 Signal black  RAL9007 Grey aluminium  RAL7016 Anthracite grey  RAL9016 Traffic white |
| Gasket | Silicone CCG® Controlled Compression Gasket |
| Fasteners | PCS hardware |
| Ingress protection | IP66 |
| Impact resistance | IK09 |
| Corrosion resistance | 5CE |
| Windage | 0.104 m ² |

Electrical description

| | |
|------------------|--|
| Power supply | 220-240V / 50-60 Hz |
| Driver / Ballast | Integral electronic converter with DALI interface in thermally separated compartment |
| Power factor | > 0.9 |

Additional information

| | |
|------------|--|
| Lifetime | Ta=25° L70B50 > 50000h |
| BUG Rating | Please see individual Spec Sheets for classification of Backlight, Uplight and Glare |



ZFT430-FT LED

Pole mounted



we-ef

Options

Light distribution

| | |
|--|---|
|  | symmetric distribution [C60] |
|  | controlled symmetric distribution [C50] |
|  | rectangular [R50] |



Colour temperature

| | |
|---|--------|
|  | 3000 K |
|  | 4000 K |
|  | 2700 K |

Nominal Watt

27 W
24 W
2 W
42 W

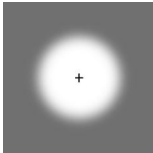
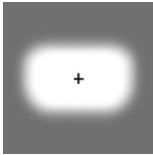
Configurations

| Light distribution | Part ID | Light source | Rated lumens | Rated input power | CRI | Weight (kg) |
|---|--|------------------------------|------------------------------|-------------------|------|-------------|
| controlled symmetric distribution [C50]  | 115-1531 | LED-FT-12W / 350 mA - 3000 K | 1698 | 14 W | 80 | 5.40 |
| | 115-1532 | LED-FT-12W / 350 mA - 4000 K | 1789.1 | 14 W | 80 | 5.40 |
| | 115-1535 | LED-FT-24W / 700 mA - 3000 K | 3495.5 | 27 W | 80 | 5.40 |
| | 115-1536 | LED-FT-24W / 700 mA - 4000 K | 3644.6 | 27 W | 80 | 5.40 |
| | 115-1582 | LED-FT-12W / 350 mA - 2700 K | 1590.4 | 14 W | 80 | 5.40 |
| | 115-1583 | LED-FT-24W / 700 mA - 2700 K | 3354.7 | 27 W | 80 | 5.40 |
| rectangular [R50]  | 115-1841 | LED-FT-12W / 350 mA - 3000 K | 1578.2 | 14 W | 80 | 5.40 |
| | 115-1853 | LED-FT-12W / 350 mA - 4000 K | 1662.9 | 14 W | 80 | 5.40 |
| | 115-1854 | LED-FT-12W / 350 mA - 2700 K | 1478.2 | 14 W | 80 | 5.40 |
| | 115-1855 | LED-FT-24W / 700 mA - 3000 K | 3248.9 | 27 W | 80 | 5.40 |
| | 115-1856 | LED-FT-24W / 700 mA - 4000 K | 3387.4 | 27 W | 80 | 5.40 |
| | 115-1857 | LED-FT-24W / 700 mA - 2700 K | 3118 | 27 W | 80 | 5.40 |
| | 115-1858 | LED-FT-37W / 700 mA - 3000 K | 4873.3 | 42 W | 80 | 5.40 |
| | 115-1859 | LED-FT-37W / 700 mA - 4000 K | 5154.3 | 42 W | 80 | 5.40 |
| | 115-1860 | LED-FT-37W / 700 mA - 2700 K | 4730.9 | 42 W | 80 | 5.40 |
| | 115-2074 | LED-FT-17W / 500 mA - 3000 K | 2363.5 | 20 W | 80 | 5.40 |
| | 115-2075 | LED-FT-17W / 500 mA - 4000 K | 2463.6 | 20 W | 80 | 5.40 |
| | 115-2076 | LED-FT-17W / 500 mA - 2700 K | 2259.6 | 20 W | 80 | 5.40 |
| | symmetric distribution [C60]  | 115-1241 | LED-FT-24W / 700 mA - 3000 K | 2609.8 | 27 W | 80 |
| 115-1242 | | LED-FT-24W / 700 mA - 4000 K | 2721.1 | 27 W | 80 | 5.40 |
| 115-1343 | | LED-FT-12W / 350 mA - 3000 K | 1267.8 | 14 W | 80 | 5.40 |
| 115-1344 | | LED-FT-12W / 350 mA - 4000 K | 1335.8 | 14 W | 80 | 5.40 |
| 115-1585 | | LED-FT-12W / 350 mA - 2700 K | 1187.4 | 14 W | 80 | 5.40 |
| 115-1586 | | LED-FT-24W / 700 mA - 2700 K | 2504.7 | 27 W | 80 | 5.40 |

Pole mounted

Mounting Accessories

Wall and pole brackets RZ

| Description | Part ID | C1 | D1 | D2 | D × L1 | M1 | Weight (kg) |
|------------------------------|----------|-----|-----|-----|---------|----|-------------|
| Wall bracket RZO-400, single | 115-1324 | 277 | 231 | 195 | 76 x 80 | 12 | 3.50 |

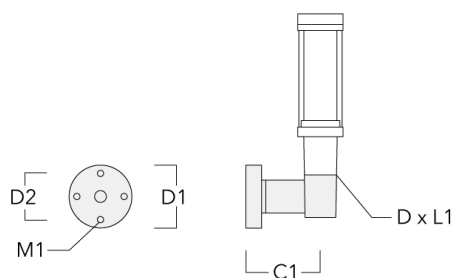

| | | | | | | | |
|------------------------------|----------|-----|--|--|----------|--|------|
| Pole bracket RZ2-400, double | 115-1323 | 258 | | | 76 x 100 | | 4.90 |
|------------------------------|----------|-----|--|--|----------|--|------|

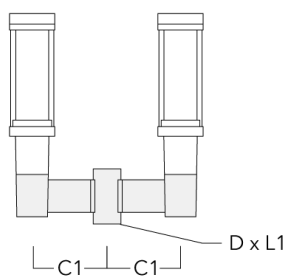

Pole mounted

Optical Accessories

Light shield

| Description | Part ID | H1 |
|-----------------------|----------|-----|
| Cut-off shield IL-180 | 159-0321 | 120 |

