

RMT320 LED Two-sided

Pole mounted

we-ef

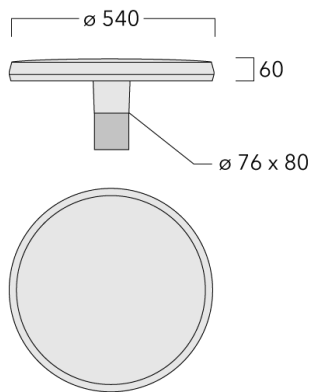
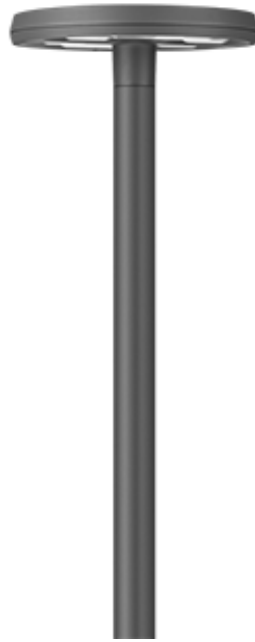

Description

IP66. Class I. Class II on request. IK09. Marine-grade, die-cast aluminium alloy. 5CE superior corrosion protection including PCS hardware. Silicone CCG® Controlled Compression Gasket. RFC® Reflection Free Contour main lens. Integral EC electronic converter, thermally separated. DALI. CAD-optimised optics for superior illumination and glare control. OLC® One LED Concept. Factory installed LED circuit board. The luminaire is factory-sealed and does not need to be opened during installation.

Optional 2200 K version up to max. 1050mA available. To be specified at time of ordering.

Fagerhult Lighting Ltd

33-34 Dolben Street, SE1 0UQ London, United Kingdom

<https://we-ef.com/uk>





Subject to technical changes and errors. - Generated on 23/11/2024

RMT320 LED Two-sided

Pole mounted

Specifications

Material description

Body	Marine-grade, die-cast aluminium alloy
Lens	RFC® Reflection Free Contour technology
Colours	 RAL9004 Signal black  RAL9006 White aluminium  RAL9007 Grey aluminium  RAL7016 Anthracite grey  RAL9016 Traffic white
Gasket	Silicone CCG® Controlled Compression Gasket
Fasteners	PCS Polymer Coated Stainless Steel Hardware
Ingress protection	IP66
Impact resistance	IK09
Corrosion resistance	5CE
Windage	0.23 m ²

Electrical description

Power supply	220-240V / 50-60 Hz
Driver / Ballast	Integral EC electronic converter. DALI
Power factor	> 0.9
Surge protection	6/6 kV (optional SP10)

Additional information

Lifetime	Ta=25° L90B10 > 90000h
Energy efficiency class	C-D (Light source)

RMT320 LED Two-sided

Pole mounted

we-ef

Options

Light distribution



asymmetric, side throw beam [S65]



rectangular, side throw [R65]



pedestrian/bicycle lane [P65]



asymmetric, side throw beam [S70]

Colour temperature



3000 K



4000 K



2700 K

Nominal Watt

29 W

58 W

0 W

RMT320 LED Two-sided

Pole mounted

Configurations

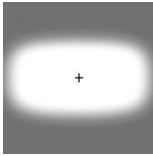
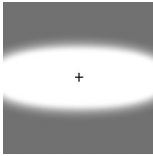
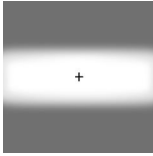
Light distribution	Part ID	Light source	Rated lumens	Rated input power	CRI	Weight (kg)
asymmetric, side throw beam [S65] 	105-0201	LED-24/24W / 350 mA - 2700 K	3219.5	27 W	80	8.00
	105-0201-70	LED-24/24W / 350 mA - 2700 K	3441.5	27 W	70	8.00
	105-0202	LED-24/48W / 700 mA - 2700 K	5682.3	54 W	80	8.00
	105-0202-70	LED-24/48W / 700 mA - 2700 K	6103.3	54 W	70	8.00
	105-0203	LED-24/72W / 1050 mA - 2700 K	9103.3	79 W	80	8.00
	105-0203-70	LED-24/72W / 1050 mA - 2700 K	10435.5	79 W	70	8.00
	105-9876	LED-24/24W / 350 mA - 3000 K	3441.5	27 W	80	8.00
	105-9876-70	LED-24/24W / 350 mA - 3000 K	3996.6	27 W	70	8.00
	105-9877	LED-24/48W / 700 mA - 3000 K	6103.3	54 W	80	8.00
	105-9877-70	LED-24/48W / 700 mA - 3000 K	6945.1	54 W	70	8.00
	105-9886	LED-24/24W / 350 mA - 4000 K	3774.5	27 W	80	8.00
	105-9886-70	LED-24/24W / 350 mA - 4000 K	4218.6	27 W	70	8.00
	105-9887	LED-24/48W / 700 mA - 4000 K	6524.2	54 W	80	8.00
	105-9887-70	LED-24/48W / 700 mA - 4000 K	7366	54 W	70	8.00
	105-9932	LED-24/72W / 1050 mA - 3000 K	9547.4	79 W	80	8.00
	105-9932-70	LED-24/72W / 1050 mA - 3000 K	10879.6	79 W	70	8.00
105-9938	LED-24/72W / 1050 mA - 4000 K	9991.4	79 W	80	8.00	
105-9938-70	LED-24/72W / 1050 mA - 4000 K	11323.6	79 W	70	8.00	
asymmetric, side throw beam [S70] 	105-9944-70	LED-24/72W / 1050 mA - 3000 K	10820.6	79 W	70	8.00
pedestrian/bicycle lane [P65] 	105-0207	LED-24/24W / 350 mA - 2700 K	3095.7	27 W	80	8.00
	105-0207-70	LED-24/24W / 350 mA - 2700 K	3309.2	27 W	70	8.00
	105-0208	LED-24/48W / 700 mA - 2700 K	5463.9	54 W	80	8.00
	105-0208-70	LED-24/48W / 700 mA - 2700 K	5868.7	54 W	70	8.00
	105-0209	LED-24/72W / 1050 mA - 2700 K	8753.5	79 W	80	8.00
	105-0209-70	LED-24/72W / 1050 mA - 2700 K	10034.5	79 W	70	8.00
	105-7012	LED-24/24W / 350 mA - 3000 K	3309.2	27 W	80	8.00
	105-7012-70	LED-24/24W / 350 mA - 3000 K	3843	27 W	70	8.00
	105-7013	LED-24/48W / 700 mA - 3000 K	5868.7	54 W	80	8.00
	105-7013-70	LED-24/48W / 700 mA - 3000 K	6678.1	54 W	70	8.00
	105-7018	LED-24/72W / 1050 mA - 3000 K	9180.5	79 W	80	8.00
	105-7018-70	LED-24/72W / 1050 mA - 3000 K	10461.5	79 W	70	8.00

Fagerhult Lighting Ltd

33-34 Dolben Street, SE1 0UQ London, United Kingdom

<https://we-ef.com/uk>

Subject to technical changes and errors. - Generated on 23/11/2024

RMT320 LED Two-sided

Pole mounted

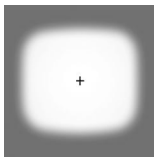
Light distribution	Part ID	Light source	Rated lumens	Rated input power	CRI	Weight (kg)
	105-7028	LED-24/24W / 350 mA - 4000 K	3629.5	27 W	80	8.00
	105-7028-70	LED-24/24W / 350 mA - 4000 K	4056.5	27 W	70	8.00
	105-7029	LED-24/48W / 700 mA - 4000 K	6273.4	54 W	80	8.00
	105-7029-70	LED-24/48W / 700 mA - 4000 K	7082.9	54 W	70	8.00
	105-7034	LED-24/72W / 1050 mA - 4000 K	9607.5	79 W	80	8.00
	105-7034-70	LED-24/72W / 1050 mA - 4000 K	10888.5	79 W	70	8.00
rectangular, side throw [R65]	105-0204	LED-24/24W / 350 mA - 2700 K	3014.5	27 W	80	8.00
	105-0204-70	LED-24/24W / 350 mA - 2700 K	3222.4	27 W	70	8.00
	105-0205	LED-24/48W / 700 mA - 2700 K	5320.6	54 W	80	8.00
	105-0205-70	LED-24/48W / 700 mA - 2700 K	5714.7	54 W	70	8.00
	105-0206	LED-24/72W / 1050 mA - 2700 K	8523.9	79 W	80	8.00
	105-0206-70	LED-24/72W / 1050 mA - 2700 K	9771.3	79 W	70	8.00
	105-7040	LED-24/72W / 1050 mA - 3000 K	8939.7	79 W	80	8.00
	105-7040-70	LED-24/72W / 1050 mA - 3000 K	10187.1	79 W	70	8.00
	105-7046	LED-24/72W / 1050 mA - 4000 K	9355.5	79 W	80	8.00
	105-7046-70	LED-24/72W / 1050 mA - 4000 K	10602.9	79 W	70	8.00
	105-7120-70	LED-12/24W / 700 mA - 2700 K	2857.4	27 W	70	8.00
	105-9915-70	LED-12/24W / 700 mA - 3000 K	3251.5	27 W	70	0.00
	105-9916	LED-24/24W / 350 mA - 3000 K	3222.4	27 W	80	8.00
	105-9916-70	LED-24/24W / 350 mA - 3000 K	3742.2	27 W	70	8.00
	105-9917	LED-24/48W / 700 mA - 3000 K	5714.7	54 W	80	8.00
	105-9917-70	LED-24/48W / 700 mA - 3000 K	6503	54 W	70	8.00
	105-9925-70	LED-12/24W / 700 mA - 4000 K	3448.6	27 W	70	0.00
	105-9926	LED-24/24W / 350 mA - 4000 K	3534.3	27 W	80	8.00
	105-9926-70	LED-24/24W / 350 mA - 4000 K	3950.1	27 W	70	8.00
	105-9927	LED-24/48W / 700 mA - 4000 K	6108.9	54 W	80	8.00
	105-9927-70	LED-24/48W / 700 mA - 4000 K	6897.1	54 W	70	8.00

RMT320 LED Two-sided

Pole mounted

we-ef

Control

Eco Step Dim® Basic

Description	Part ID
Eco Step Dim® Basic LED	430-0001

Eco Step Dim® Advanced

Description	Part ID
Eco Step Dim® Advanced LED	430-0002

Fagerhult Lighting Ltd

33-34 Dolben Street, SE1 0UQ London, United Kingdom

<https://we-ef.com/uk>

Subject to technical changes and errors. - Generated on 23/11/2024